

1

2

3

4

D

D

1161chip
1161.sch

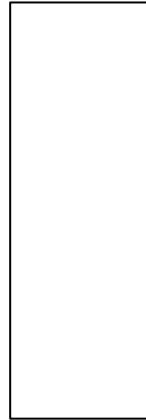

pcichip
pci.sch

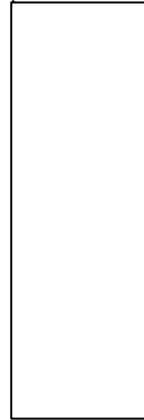

p1d
p1d.sch

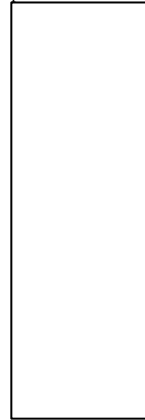

C

C

ISP1161 PCI Card v 1.0

B

B

A

A

Title		
Size	Number	Revision
A		
Date:	15-Oct-2001	Sheet of
File:	F:\Jason Backup 030701\Philips\ISP1161\Hardware\PCB\Git v1.0\pci.DDB	

1

2

3

4

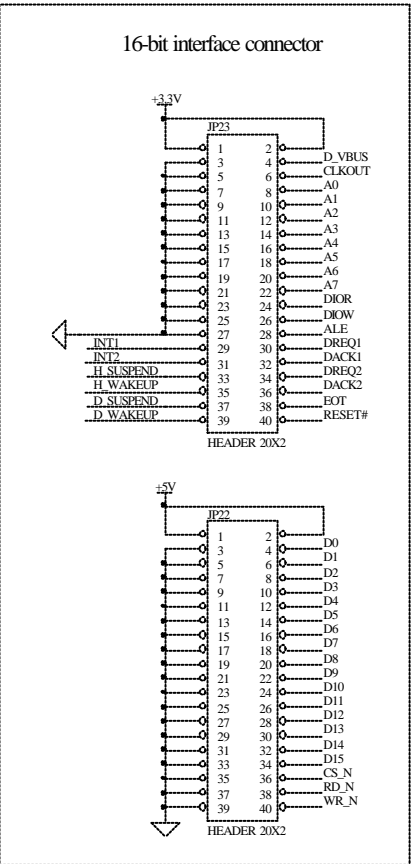
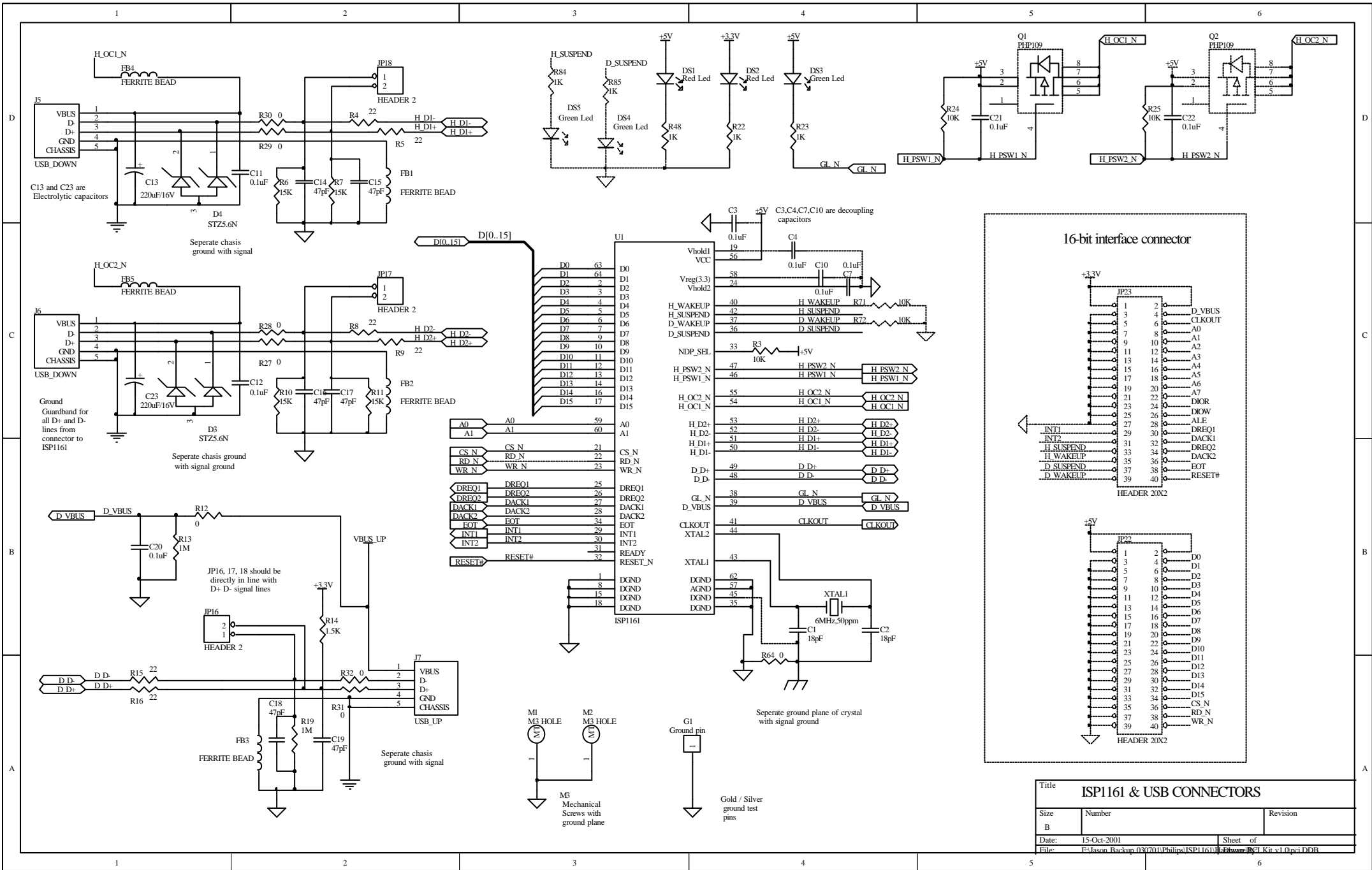

Title		
ISIP161 & USB CONNECTORS		
Size	Number	Revision
B		
Date:	15-Oct-2001	Sheet of
File:		F:\Jason_Backup_03\0701\Philips\ISIP161\Hardware\PC1_K6.v1.0.pci.DDB

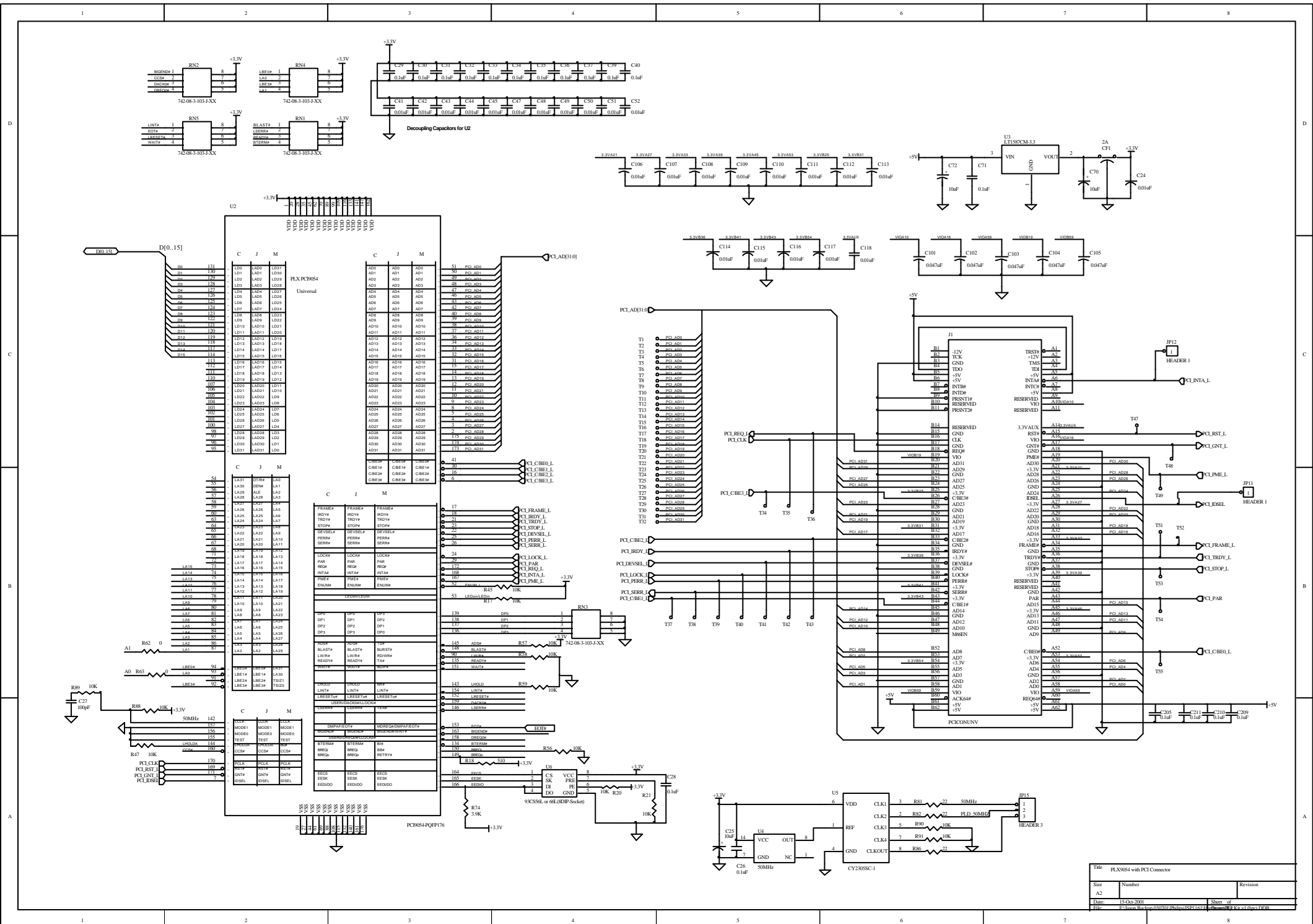

Title		
PLX964 with PCI Connector		
Size	Number	Revision
A2	18-Oct-2001	1
Date:	18-Oct-2001	Sheet of
File: F:\Data\Hardware\PCI\PLX964\PCB\PLX964_Kic_11.Dwg-PCB		

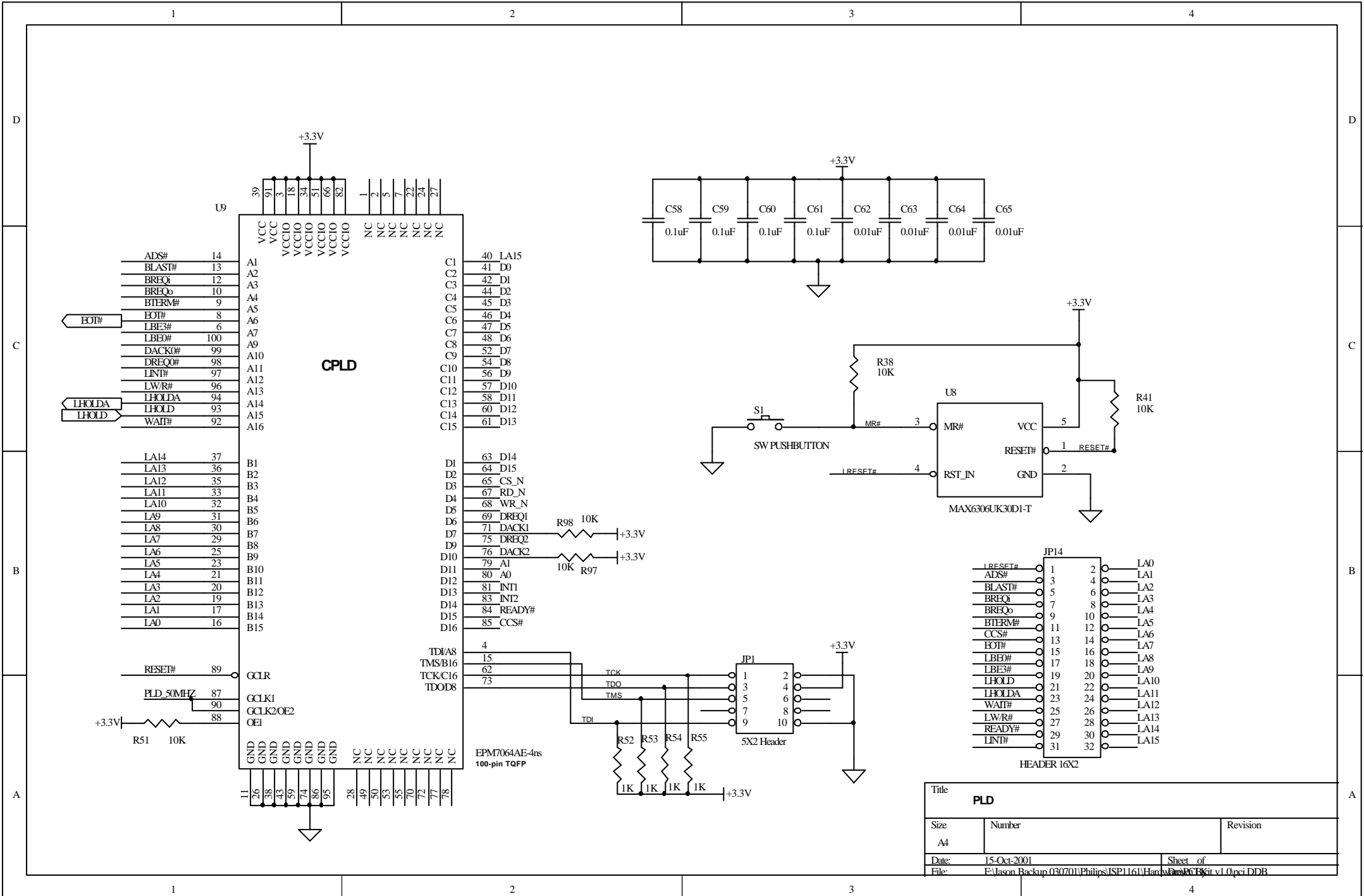

Title PLD		
Size A4	Number	Revision
Date: 15-Oct-2001	Sheet of	
File: E:\Jason Backup\030701\Philips\ISP1161\Hardware\PCB\Kit v1.0\pci.DDB		