

MF1ICS70

Functional specification

Rev. 4.1 — 29 January 2008
043541

Product data sheet
PUBLIC

1. General description

NXP has developed the MIFARE MF1ICS70 to be used in a contactless smart card according to ISO/IEC 14443 Type A.

The MIFARE MF1ICS70 IC is used in applications like public transport ticketing where major cities have adopted MIFARE as their e-ticketing solution of choice.

1.1 Key applications

- Public transportation
- Access control
- Event ticketing
- Gaming & identity

1.2 Anticollision

An intelligent anticollision function allows to operate more than one card in the field simultaneously. The anticollision algorithm selects each card individually and ensures that the execution of a transaction with a selected card is performed correctly without data corruption resulting from other cards in the field.

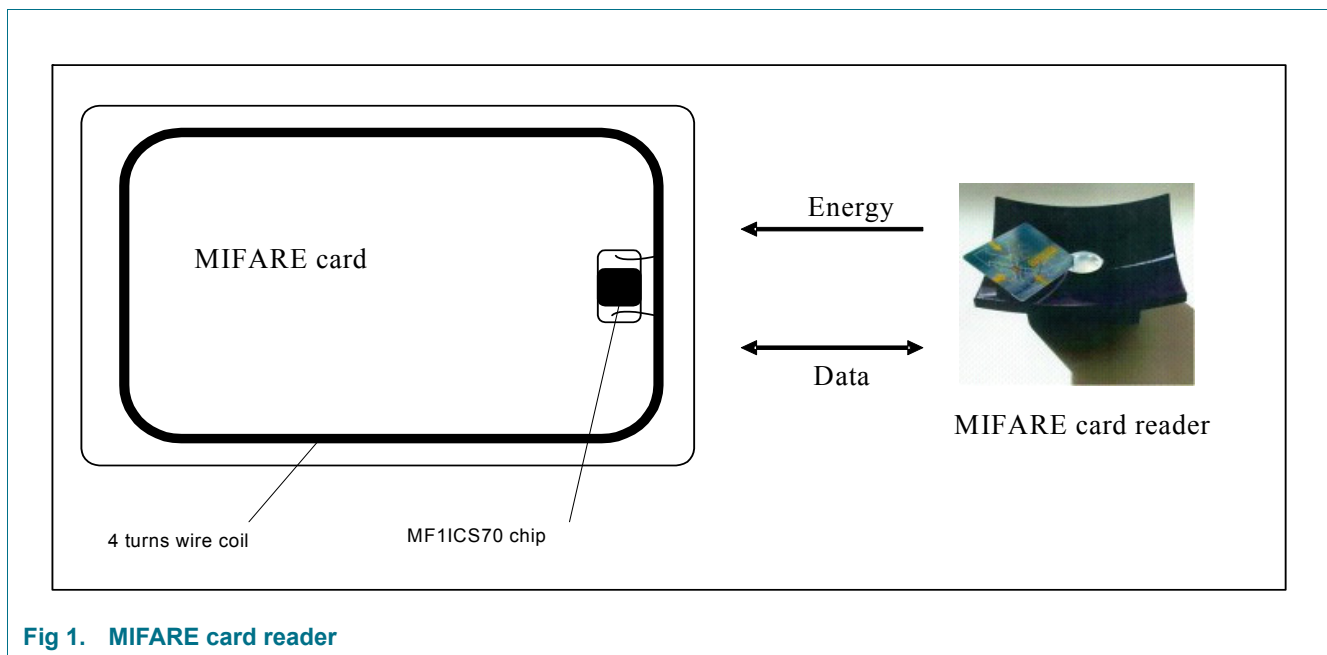

1.3 Simple integration and user convenience

The MF1ICS70 is designed for simple integration and user convenience. Which could allow complete ticketing transactions to be handled in less than 100 ms. Thus, the MF1ICS70 card user is not forced to stop at the reader leading to a high throughput at gates and reduced boarding times onto busses. The MIFARE card may also remain in the wallet during the transaction, even if there are coins in it.

1.4 Security

Several security measures like mutual challenge and response authentication, data ciphering and message authentication checks support the protection of the system against various attack scenarios. The UID of the IC as a base of key diversification supports the security concept.

1.5 Delivery options

- Die on wafer
- Bumped die on wafer
- MOA4 or MOA2 contactless card module
- Flip chip package

2. Features

2.1 MIFARE, RF Interface (ISO/IEC 14443 A)

- Contactless transmission of data and supply energy (no battery needed)
- Operating distance: Up to 100mm (depending on antenna geometry)
- Operating frequency: 13.56 MHz
- Data transfer: 106 kbit/s
- Data integrity: 16 Bit CRC, parity, bit coding, bit counting
- Anticollision
- Typical ticketing transaction: < 100 ms (including backup management)

2.2 EEPROM

- 4 Kbyte, organised in 32 sectors with 4 blocks and 8 sectors with 16 blocks (one block consists of 16 bytes)
- User definable access conditions for each memory block
- Data retention of 10 years.
- Write endurance 100.000 cycles

2.3 Security

- Mutual three pass authentication (ISO/IEC DIS 9798-2)
- Individual set of two keys per sector (per application) to support multi-application with key hierarchy
- Unique serial number for each device

3. Ordering information

[See Delivery Type Addendum of Device](#)

4. Block diagram

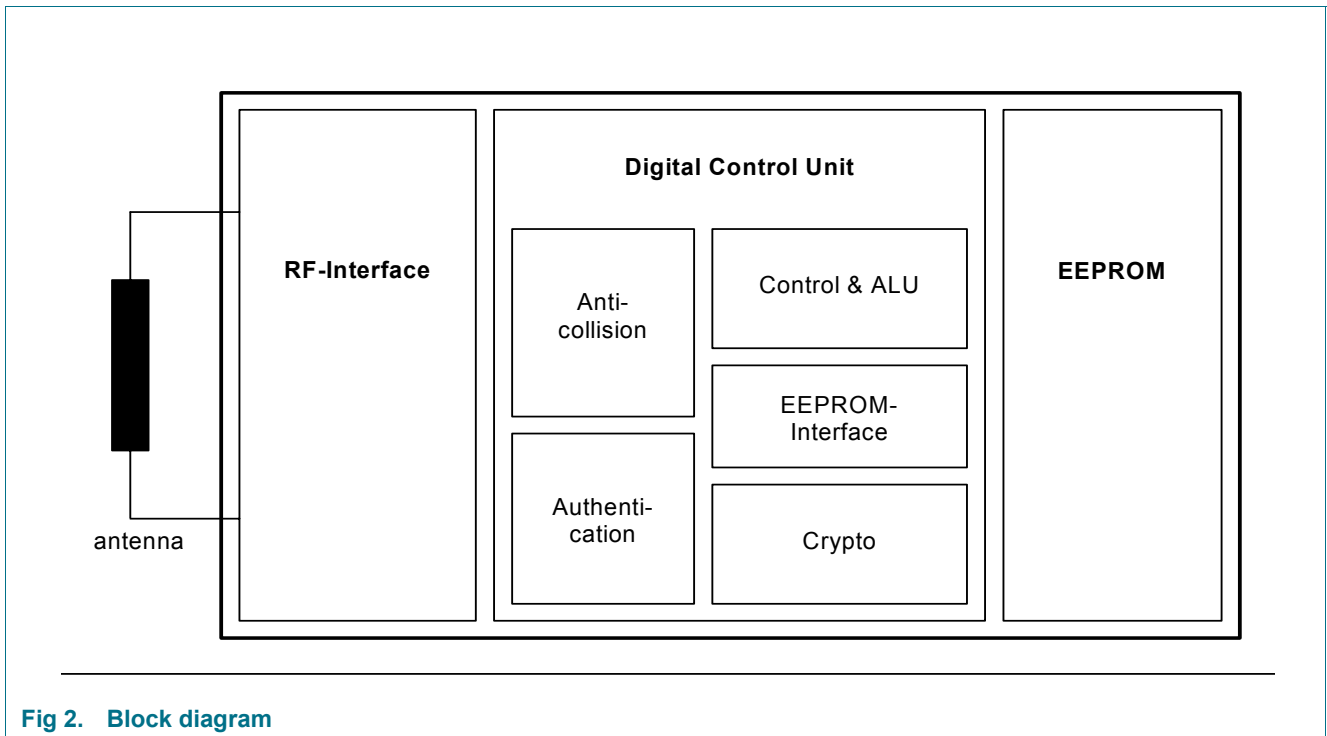

Fig 2. Block diagram

5. Pinning information

5.1 Pinning

[See Delivery Type Addendum of Device](#)

6. Functional description

6.1 Block description

The MF1ICS70 chip consists of the 4 Kbytes EEPROM, the RF-Interface and the Digital Control Unit. Energy and data are transferred via an antenna, which consists of a coil with a few turns directly connected to the MF1IC 70. No further external components are necessary. (For details on antenna design please refer to the document MIFARE, Card IC Coil Design Guide.)

- RF-Interface:
 - Modulator/Demodulator
 - Rectifier
 - Clock Regenerator
 - Power On Reset
 - Voltage Regulator
- Anticollision: Several cards in the field may be selected and operated in sequence
- Authentication: Preceding any memory operation the authentication procedure ensures that access to a block is only possible via the two keys specified for each block
- Control & Arithmetic Logic Unit: Values are stored in a special redundant format and can be incremented and decremented
- EEPROM-Interface
- Crypto unit: The CRYPTO1 stream cipher of the MF1ICS70 is used for authentication and encryption of data exchange.
- EEPROM: 4 Kbytes are organised in 32 sectors with 4 blocks each and 8 sectors with 16 blocks each. One block contains 16 bytes. The last block of each sector is called “sector trailer”, which contains two secret keys and programmable access conditions for each sector.

6.2 Communication principle

The commands are initiated by the reader and controlled by the Digital Control Unit of the MF1ICS70 according to the access conditions valid for the corresponding sector.

6.2.1 Request standard/all

After Power On Reset (POR) of a card it can answer to a request command - sent by the reader to all cards in the antenna field - by sending the answer to request code (ATQA according to ISO/IEC 14443A).

6.2.2 Anticollision loop

In the anticollision loop the serial number of a card is read. If there are several cards in the operating range of the reader, they can be distinguished by their unique serial numbers and one can be selected (select card) for further transactions. The unselected cards return to the standby mode and wait for a new request command.

6.2.3 Select card

With the select card command the reader selects one individual card for authentication and memory related operations. The card returns the Answer To Select (ATS) code (=18h), which determines the type of the selected card. Please refer to the document "MIFARE, Standardized Card Type Identification Procedure" for further details.

6.2.4 Three pass authentication

After selection of a card the reader specifies the memory location of the following memory access and uses the corresponding key for the three pass authentication procedure. After a successful authentication all memory operations are encrypted.

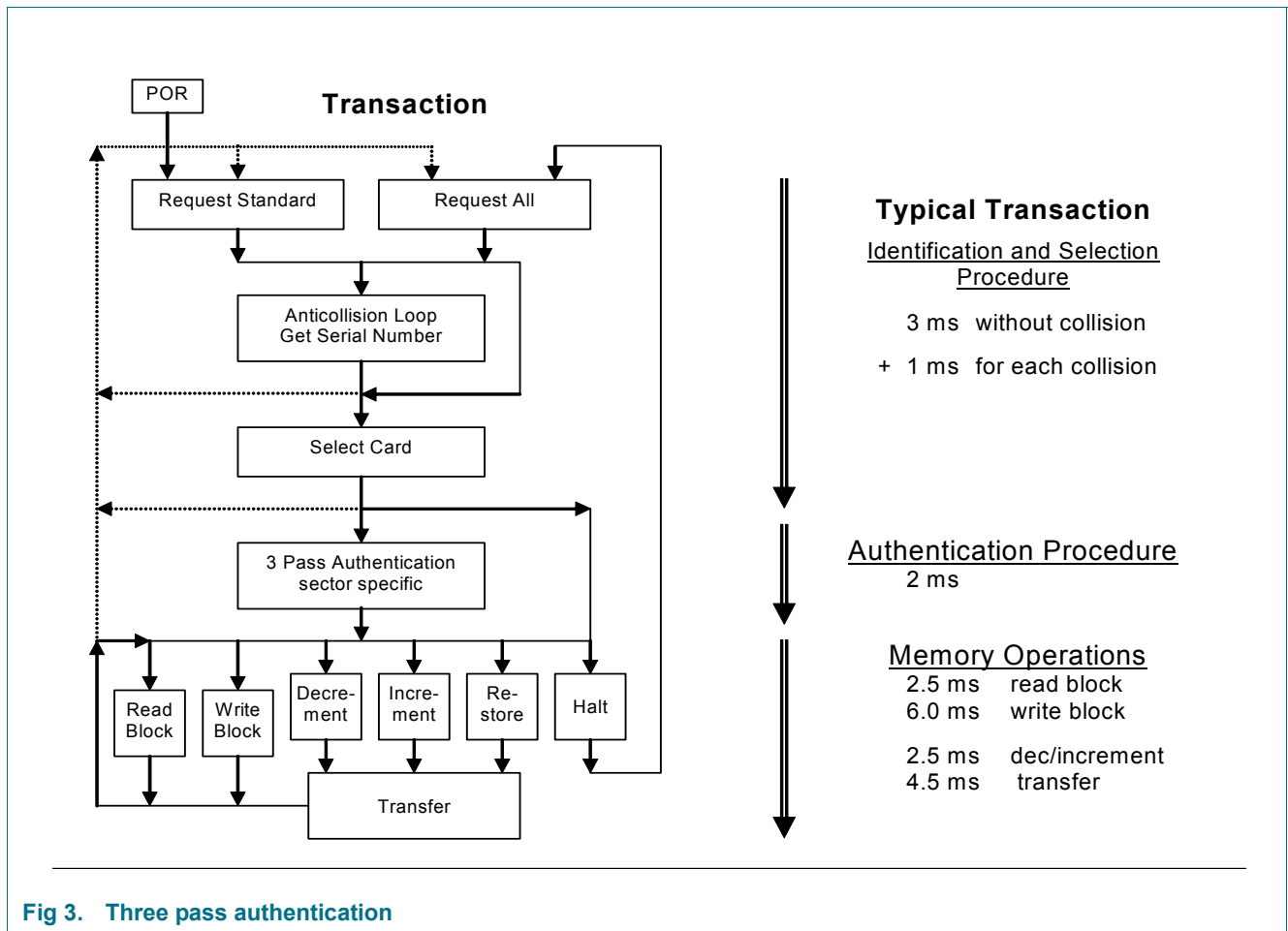

Fig 3. Three pass authentication

6.2.5 Memory operations

After authentication any of the following operations may be performed:

- Read block
- Write block
- Decrement: Decrements the content of a block and stores the result in a temporary internal data-register
- Increment: Increments the content of a block and stores the result in the data-register
- Restore: Moves the content of a block into the data-register
- Transfer: Writes the content of the temporary internal data-register to a value block

6.3 Data integrity

Following mechanisms are implemented in the contactless communication link between reader and card to ensure very reliable data transmission:

- 16 bits CRC per block
- Parity bits for each byte
- Bit count checking
- Bit coding to distinguish between "1", "0", and no information
- Channel monitoring (protocol sequence and bit stream analysis)

6.4 Three pass authentication sequence

1. The reader specifies the sector to be accessed and chooses key A or B.
2. The card reads the secret key and the access conditions from the sector trailer. Then the card sends a random number as the challenge to the reader (pass one).
3. The reader calculates the response using the secret key and additional input. The response, together with a random challenge from the reader, is then transmitted to the card (pass two).
4. The card verifies the response of the reader by comparing it with its own challenge and then it calculates the response to the challenge and transmits it (pass three).
5. The reader verifies the response of the card by comparing it to its own challenge

After transmission of the first random challenge the communication between card and reader is encrypted.

6.5 RF interface

The RF-interface is according to the standard for contactless smart cards ISO/IEC 14443 A.

The carrier field from the reader is always present (with short pauses when transmitting), because it is used for the power supply of the card.

For both directions of data communication there is only one start bit at the beginning of each frame. Each byte is transmitted with a parity bit (odd parity) at the end. The LSB of the byte with the lowest address of the selected block is transmitted first. The maximum frame length is 163 bits (16 data bytes + 2 CRC bytes = 16 * 9 + 2 * 9 + 1 start bit).

6.6 Memory organization

The 4 kByte EEPROM memory is organised in 32 sectors with 4 blocks and in 8 sectors with 16 blocks. One block consists of 16 bytes. In the erased state the EEPROM cells are read as a logical “0”, in the written state as a logical “1”.

Sector	Block	Byte Number within a Block																Description
		0	1	2	3	4	5	6	7	8	9	10	11	12	13	14	15	
15	3	Key A					Access Bits				Key B						Sector Trailer 15	
	2																	Data
	1																	Data
	0																	Data
14	3	Key A					Access Bits				Key B						Sector Trailer 14	
	2																	Data
	1																	Data
	0																	Data
:	:																	
:	:																	
:	:																	
1	3	Key A					Access Bits				Key B						Sector Trailer 1	
	2																	Data
	1																	Data
	0																	Data
0	3	Key A					Access Bits				Key B						Sector Trailer 0	
	2																	Data
	1																	Data
	0																	Manufacturer Block

Fig 4. Memory organization

6.6.1 Manufacturer block

This is the first data block (block 0) of the first sector (sector 0). It contains the IC manufacturer data. Due to security and system requirements this block is write protected after having been programmed by the IC manufacturer at production.

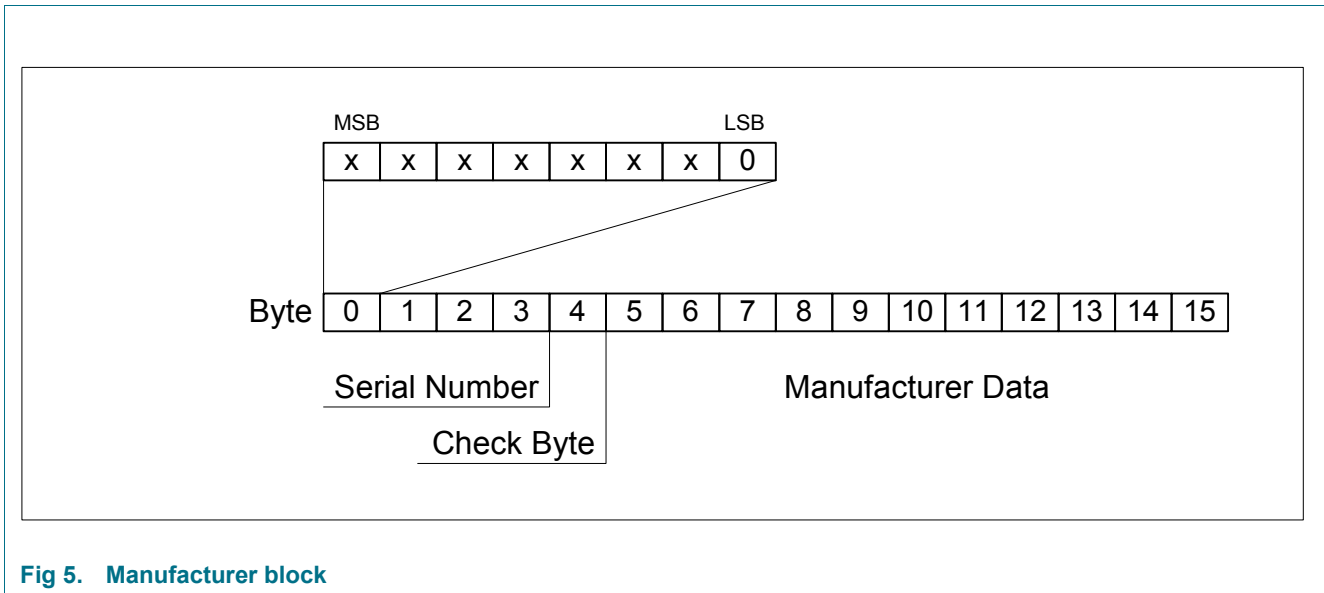

Fig 5. Manufacturer block

6.6.2 Data blocks

Sectors 0 .. 31 contain 3 blocks and sectors 32 .. 39 contain 15 blocks for storing data. (Sector 0 contains only two data blocks and the read-only manufacturer block).

The data blocks can be configured by the access bits as

- read/write blocks for e.g. contactless access control or
- value blocks for e.g. electronic purse applications, where additional commands like increment and decrement for direct control of the stored value are provided.

An authentication command has to be carried out before any operation in order to allow further commands.

6.6.2.1 Value Blocks

The value blocks allow to perform electronic purse functions (valid commands: read, write, increment, decrement, restore, transfer). The value blocks have a fixed data format which permits error detection and correction and a backup management. A value block can only be generated through a write operation in the value block format:

A value block can only be generated through a write operation in the value block format:

- Value: Signifies a signed 4-byte value. The lowest significant byte of a value is stored in the lowest address byte. Negative values are stored in standard 2's complement format. For reasons of data integrity and security, a value is stored three times, twice non-inverted and once inverted.

- Adr: Signifies a 1-byte address, which can be used to save the storage address of a block, when implementing a powerful backup management. The address byte is stored four times, twice inverted and non-inverted. During increment, decrement, restore and transfer operations the address remains unchanged. It can only be altered via a write command.

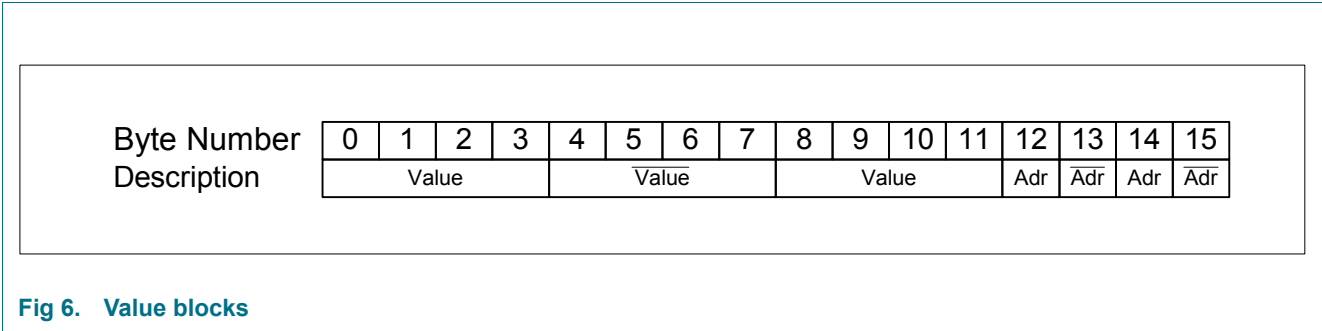

6.6.3 Sector trailer

Each sector has a sector trailer. Due to the memory configuration of the MF1ICS70 this sector trailer is located in block 3 of each sector in the first two kByte of the NV-memory respectively in block 15 of each sector in the upper 2 kByte of the 4 kByte NV-memory.

Each sector trailer holds the

- secret keys A and B (optional), which return logical “0”s when read and
- the access conditions for the four blocks of that sector, which are stored in bytes 6...9. The access bits also specify the type (read/write or value) of the data blocks.

If key B is not needed, the last 6 bytes of the sector trailer can be used as data bytes. Byte 9 of the sector trailer is available for user data. For this byte apply the same access rights as for byte 6, 7 and 8.

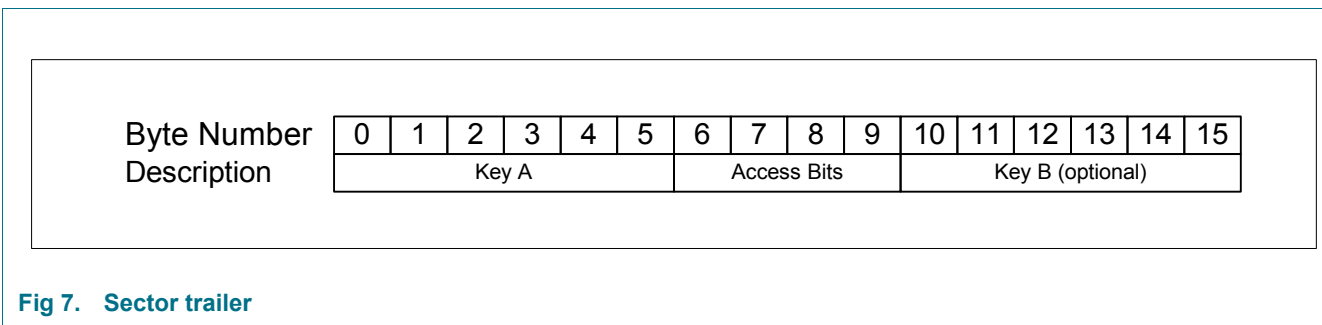

6.7 Memory access

Before any memory operation can be carried out, the card has to be selected and authenticated as described previously. The possible memory operations for an addressed block depend on the key used and the access conditions stored in the associated sector trailer.

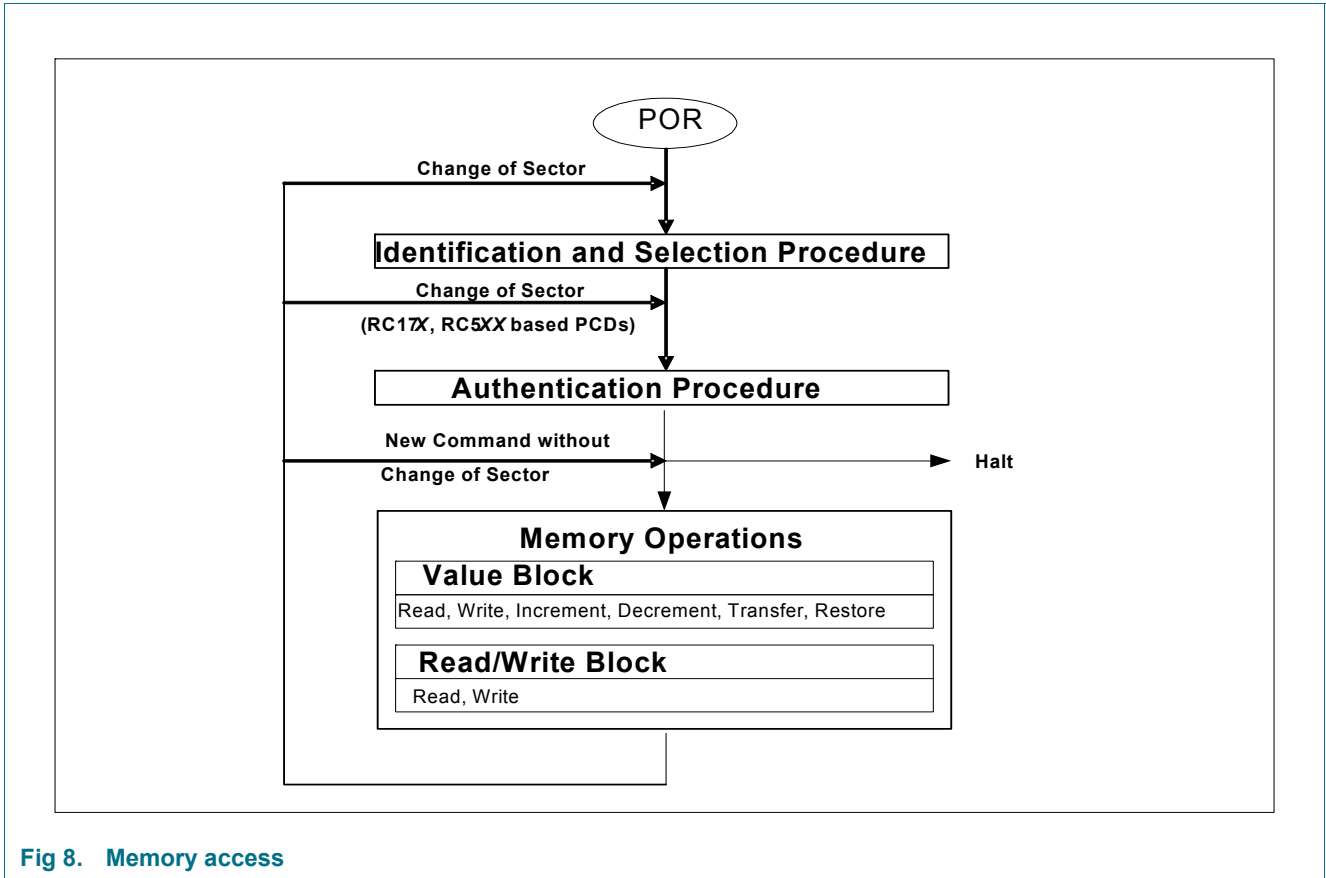

Fig 8. Memory access

Table 1. Memory operations

Operation	Description	Valid for Block Type
Read	reads one memory block	read/write, value and sector trailer
Write	writes one memory block	read/write, value and sector trailer
Increment	increments the contents of a block and stores the result in the internal data register	value
Decrement	decrements the contents of a block and stores the result in the internal data register	value
Transfer	writes the contents of the internal data register to a block	value
Restore	reads the contents of a block into the internal data register	value

6.7.1 Access conditions

The access conditions for every data block and sector trailer are defined by 3 bits, which are stored non-inverted and inverted in the sector trailer of the specified sector.

The access bits control the rights of memory access using the secret keys A and B. The access conditions may be altered, provided one knows the relevant key and the current access condition allows this operation.

Remark: With each memory access the internal logic verifies the format of the access conditions. If it detects a format violation the whole sector is irreversible blocked.

Remark: In the following description the access bits are mentioned in the non-inverted mode only.

The internal logic of the MF1ICS70 ensures that the commands are executed only after an authentication procedure or never.

Table 2. Access conditions

Access Bits	Valid Commands		Block	Description
C1 ₃ C2 ₃ C3 ₃	read, write	→	3	sector trailer
C1 ₂ C2 ₂ C3 ₂	read, write, increment, decrement, transfer, restore	→	2	data area ^[1]
C1 ₁ C2 ₁ C3 ₁	read, write, increment, decrement, transfer, restore	→	1	data area ^[1]
C1 ₀ C2 ₀ C3 ₀	read, write, increment, decrement, transfer, restore	→	0	data area ^[1]

[1] For the first 32 sectors (first 2 Kbytes of NV-memory) the access conditions can be set individually for a data area sized one block.
 For the last 8 sectors (upper 2 Kbytes of NV-memory) access conditions can be set individually for a data area sized 5 blocks.

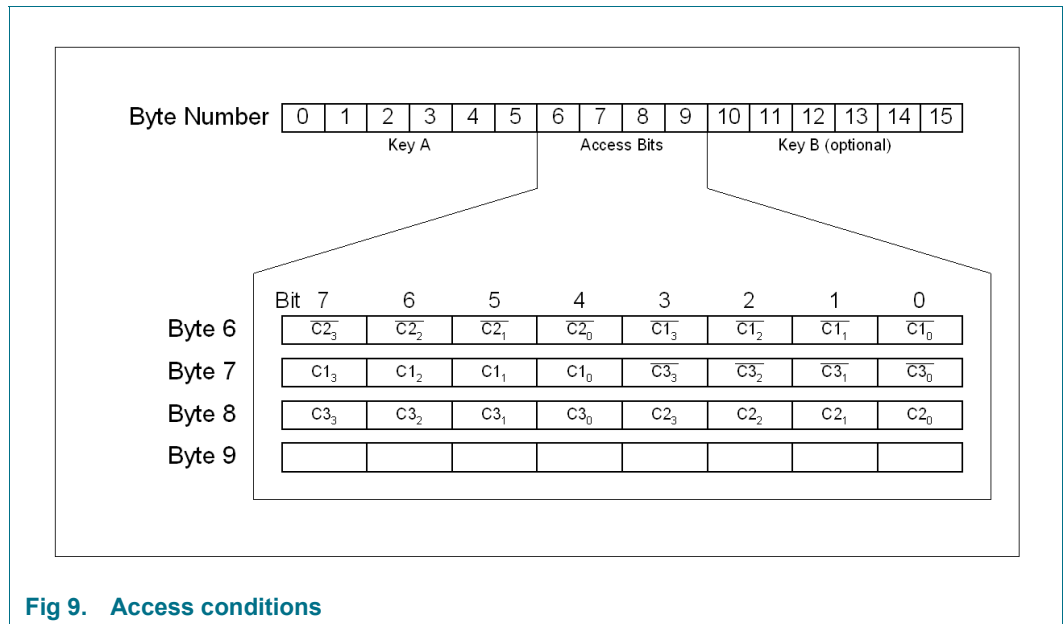

Fig 9. Access conditions

6.7.2 Access conditions for the sector trailer

Depending on the access bits for the sector trailer (block 3) the read/write access to the keys and the access bits is specified as 'never', 'key A', 'key B' or key A|B' (key A or key B).

On chip delivery the access conditions for the sector trailers and key A are predefined as transport configuration. Since key B may be read in transport configuration, new cards must be authenticated with key A. Since the access bits themselves can also be blocked, special care should be taken during personalization of cards.

Table 3. Access conditions for the sector trailer

Access bits			Access condition for							Remark
			KEYA		Access bits		KEYB			
C1	C2	C3	read	write	read	write	read	write		
0	0	0	never	key A	key A	never	key A	key A	Key B may be read	
0	1	0	never	never	key A	never	key A	never	Key B may be read	
1	0	0	never	key B	key A B	never	never	key B		
1	1	0	never	never	key A B	never	never	never		
0	0	1	never	key A	key A	key A	key A	key A	Key B may be read, transport configuration	
0	1	1	never	key B	key A B	key B	never	key B		
1	0	1	never	never	key A B	key B	never	never		
1	1	1	never	never	key A B	never	never	never		

Remark: the grey marked lines are access conditions where key B is readable and may be used for data.

6.7.3 Access conditions for data blocks

Depending on the access bits for data blocks (blocks 0...2) the read/write access is specified as 'never', 'key A', 'key B' or 'key A|B' (key A or key B). The setting of the relevant access bits defines the application and the corresponding applicable commands.

- Read/write block: The operations read and write are allowed.
- Value block: Allows the additional value operations increment, decrement, transfer and restore. In one case ('001') only read and decrement are possible for a non-rechargeable card. In the other case ('110') recharging is possible by using key B.
- Manufacturer block: The read-only condition is not affected by the access bits setting!
- Key management: In transport configuration key A must be used for authentication.¹

Table 4. Access conditions for data blocks

Access bits			Access condition for				Application
C1	C2	C3	read	write	increment	decrement, transfer, restore	
0	0	0	key A B ^[1]	key A B1	key A B1	key A B1	transport configuration
0	1	0	key A B ^[1]	never	never	never	read/write block
1	0	0	key A B ^[1]	key B ¹	never	never	read/write block
1	1	0	key A B ^[1]	key B ¹	key B ¹	key A B ¹	value block
0	0	1	key A B ^[1]	never	never	key A B ¹	value block
0	1	1	key B ^[1]	key B ¹	never	never	read/write block
1	0	1	key B ^[1]	never	never	never	read/write block
1	1	1	never	never	never	never	read/write block

[1] if Key B may be read in the corresponding Sector Trailer it cannot serve for authentication (all grey marked lines in previous table). Consequences: If the RWD tries to authenticate any block of a sector with key B using grey marked access conditions, the card will refuse any subsequent memory access after authentication.

1.If Key B may be read in the corresponding Sector Trailer it cannot serve for authentication (all grey marked lines in previous table). Consequences: If the reader tries to authenticate any block of a sector with key B using grey marked access conditions, the card will refuse any subsequent access after authentication.

7. Limiting values

[See Delivery Type Addendum of Device](#)

8. Recommended operating conditions

[See Delivery Type Addendum of Device](#)

9. Characteristics

[See Delivery Type Addendum of Device](#)

10. Support information

For additional information, please visit: <http://www.nxp.com>

11. Package outline

[See Delivery Type Addendum of Device](#)

12. Revision history

Table 5. Revision history

Document ID	Release date	Data sheet status	Change notice	Supersedes
043541	29 January 2008	Product data sheet		4.0
Modifications:		<ul style="list-style-type: none">• Update• General rewording of MIFARE designation and commercial conditions		
043540	7 February 2007	Product data sheet		3.1
043531	October 2002	Product data sheet		
Modifications:		<ul style="list-style-type: none">• The format of this data sheet has been redesigned to comply with the new identity guidelines of NXP Semiconductors.• Legal texts have been adapted to the new company name.		

13. Legal information

13.1 Data sheet status

Document status ^{[1][2]}	Product status ^[3]	Definition
Objective [short] data sheet	Development	This document contains data from the objective specification for product development.
Preliminary [short] data sheet	Qualification	This document contains data from the preliminary specification.
Product [short] data sheet	Production	This document contains the product specification.

[1] Please consult the most recently issued document before initiating or completing a design.

[2] The term 'short data sheet' is explained in section "Definitions".

[3] The product status of device(s) described in this document may have changed since this document was published and may differ in case of multiple devices. The latest product status information is available on the Internet at URL <http://www.nxp.com>.

13.2 Definitions

Draft — The document is a draft version only. The content is still under internal review and subject to formal approval, which may result in modifications or additions. NXP Semiconductors does not give any representations or warranties as to the accuracy or completeness of information included herein and shall have no liability for the consequences of use of such information.

Short data sheet — A short data sheet is an extract from a full data sheet with the same product type number(s) and title. A short data sheet is intended for quick reference only and should not be relied upon to contain detailed and full information. For detailed and full information see the relevant full data sheet, which is available on request via the local NXP Semiconductors sales office. In case of any inconsistency or conflict with the short data sheet, the full data sheet shall prevail.

13.3 Disclaimers

General — Information in this document is believed to be accurate and reliable. However, NXP Semiconductors does not give any representations or warranties, expressed or implied, as to the accuracy or completeness of such information and shall have no liability for the consequences of use of such information.

Right to make changes — NXP Semiconductors reserves the right to make changes to information published in this document, including without limitation specifications and product descriptions, at any time and without notice. This document supersedes and replaces all information supplied prior to the publication hereof.

Suitability for use — NXP Semiconductors products are not designed, authorized or warranted to be suitable for use in medical, military, aircraft, space or life support equipment, nor in applications where failure or malfunction of a NXP Semiconductors product can reasonably be expected to

result in personal injury, death or severe property or environmental damage. NXP Semiconductors accepts no liability for inclusion and/or use of NXP Semiconductors products in such equipment or applications and therefore such inclusion and/or use is at the customer's own risk.

Applications — Applications that are described herein for any of these products are for illustrative purposes only. NXP Semiconductors makes no representation or warranty that such applications will be suitable for the specified use without further testing or modification.

Limiting values — Stress above one or more limiting values (as defined in the Absolute Maximum Ratings System of IEC 60134) may cause permanent damage to the device. Limiting values are stress ratings only and operation of the device at these or any other conditions above those given in the Characteristics sections of this document is not implied. Exposure to limiting values for extended periods may affect device reliability.

Terms and conditions of sale — NXP Semiconductors products are sold subject to the general terms and conditions of commercial sale, as published at <http://www.nxp.com/profile/terms>, including those pertaining to warranty, intellectual property rights infringement and limitation of liability, unless explicitly otherwise agreed to in writing by NXP Semiconductors. In case of any inconsistency or conflict between information in this document and such terms and conditions, the latter will prevail.

No offer to sell or license — Nothing in this document may be interpreted or construed as an offer to sell products that is open for acceptance or the grant, conveyance or implication of any license under any copyrights, patents or other industrial or intellectual property rights.

13.4 Trademarks

Notice: All referenced brands, product names, service names and trademarks are the property of their respective owners.

MIFARE — is a trademark of NXP B.V.

14. Contact information

For additional information, please visit: <http://www.nxp.com>

For sales office addresses, send an email to: salesaddresses@nxp.com

15. Tables

Table 1. Memory operations	11	Table 4. Access conditions for data blocks	14
Table 2. Access conditions	12	Table 5. Revision history	16
Table 3. Access conditions for the sector trailer	13		

16. Figures

Fig 1. MIFARE card reader	1
Fig 2. Block diagram	3
Fig 3. Three pass authentication	5
Fig 4. Memory organization	7
Fig 5. Manufacturer block	8
Fig 6. Value blocks	9
Fig 7. Sector trailer	9
Fig 8. Memory access	10
Fig 9. Access conditions	12

continued >>

17. Contents

1	General description	1	14	Contact information	17
1.1	Key applications	1	15	Tables	18
1.2	Anticollision	1	16	Figures	18
1.3	Simple integration and user convenience	2	17	Contents	19
1.4	Security	2			
1.5	Delivery options	2			
2	Features	2			
2.1	MIFARE, RF Interface (ISO/IEC 14443 A)	2			
2.2	EEPROM	2			
2.3	Security	2			
3	Ordering information	3			
4	Block diagram	3			
5	Pinning information	3			
5.1	Pinning	3			
6	Functional description	4			
6.1	Block description	4			
6.2	Communication principle	4			
6.2.1	Request standard/all	4			
6.2.2	Anticollision loop	4			
6.2.3	Select card	5			
6.2.4	Three pass authentication	5			
6.2.5	Memory operations	6			
6.3	Data integrity	6			
6.4	Three pass authentication sequence	6			
6.5	RF interface	7			
6.6	Memory organization	7			
6.6.1	Manufacturer block	8			
6.6.2	Data blocks	8			
6.6.2.1	Value Blocks	8			
6.6.3	Sector trailer	9			
6.7	Memory access	10			
6.7.1	Access conditions	12			
6.7.2	Access conditions for the sector trailer	13			
6.7.3	Access conditions for data blocks	14			
7	Limiting values	15			
8	Recommended operating conditions	15			
9	Characteristics	15			
10	Support information	15			
11	Package outline	15			
12	Revision history	16			
13	Legal information	17			
13.1	Data sheet status	17			
13.2	Definitions	17			
13.3	Disclaimers	17			
13.4	Trademarks	17			

Please be aware that important notices concerning this document and the product(s) described herein, have been included in section 'Legal information'.



© NXP B.V. 2008.

All rights reserved.

For more information, please visit: <http://www.nxp.com>

For sales office addresses, please send an email to: salesaddresses@nxp.com

Date of release: 29 January 2008

Document identifier: 043541