

White Paper

Overview of the 3GPP Long Term Evolution Physical Layer

Jim Zyren

jzyren@freescale.com

Dr. Wes McCoy, Technical Editor

Overview

Long Term Evolution (LTE) is the next step forward in cellular 3G services. Expected in the 2008 time frame, LTE is a 3GPP standard that provides for an uplink speed of up to 50 megabits per second (Mbps) and a downlink speed of up to 100 Mbps. LTE will bring many technical benefits to cellular networks. Bandwidth will be scalable from 1.25 MHz to 20 MHz. This will suit the needs of different network operators that have different bandwidth allocations, and also allow operators to provide different services based on spectrum. LTE is also expected to improve spectral efficiency in 3G networks, allowing carriers to provide more data and voice services over a given bandwidth.

This technical white paper provides an overview of the LTE physical layer (PHY), including technologies that are new to cellular such as Orthogonal Frequency Division Multiplexing (OFDM) and Multiple Input Multiple Output (MIMO) data transmission.

Contents

| | | | |
|--|----|--|----|
| 1 Introduction | 1 | 3.1.4 Physical Signals | 17 |
| 1.1 LTE Design Goals | 1 | 3.1.5 Transport Channels | 18 |
| 2 LTE Basic Concepts | 2 | 3.1.6 Mapping Downlink Physical Channels to Transport Channels | 19 |
| 2.1 Single Carrier Modulation and Channel Equalization | 2 | 3.1.7 Downlink Channel Coding | 19 |
| 2.2 OFDM | 3 | 3.2 Uplink | 20 |
| 2.2.1 Disadvantages of OFDM | 5 | 3.2.1 Modulation Parameters | 20 |
| 2.3 OFDMA | 7 | 3.2.2 Multiplexing | 20 |
| 2.3.1 Comparison of OFDMA with Packet-Oriented Protocols | 7 | 3.2.3 Uplink Physical Channels | 20 |
| 2.3.2 OFDMA and the LTE Generic Frame Structure | 8 | 3.2.4 Uplink Physical Signals | 21 |
| 2.4 MIMO and MRC | 10 | 3.2.5 Uplink Transport Channels | 21 |
| 2.5 SC-FDMA | 13 | 3.2.6 Mapping Uplink Physical Channels to Transport Channels | 22 |
| 3 LTE Physical Layer | 14 | 3.2.7 Coding | 22 |
| 3.1 Downlink | 15 | 3.3 MB-SFN | 22 |
| 3.1.1 Modulation Parameters | 15 | 4 Conclusions | 22 |
| 3.1.2 Downlink Multiplexing | 16 | 5 References | 23 |
| 3.1.3 Physical Channels | 16 | 6 Acronyms and Abbreviations | 24 |

1 Introduction

The 3GPP Long Term Evolution (LTE) represents a major advance in cellular technology. LTE is designed to meet carrier needs for high-speed data and media transport as well as high-capacity voice support well into the next decade. It encompasses high-speed data, multimedia unicast and multimedia broadcast services. Although technical specifications are not yet finalized, significant details are emerging. This paper focuses on the LTE physical layer (PHY).

The LTE PHY is a highly efficient means of conveying both data and control information between an enhanced base station (eNodeB) and mobile user equipment (UE). The LTE PHY employs some advanced technologies that are new to cellular applications. These include Orthogonal Frequency Division Multiplexing (OFDM) and Multiple Input Multiple Output (MIMO) data transmission. In addition, the LTE PHY uses Orthogonal Frequency Division Multiple Access (OFDMA) on the downlink (DL) and Single Carrier – Frequency Division Multiple Access (SC-FDMA) on the uplink (UL). OFDMA allows data to be directed to or from multiple users on a subcarrier-by-subcarrier basis for a specified number of symbol periods. Due to the novelty of these technologies in cellular applications, they are described separately before delving into a description of the LTE PHY.

Although the LTE specs describe both Frequency Division Duplexing (FDD) and Time Division Duplexing (TDD) to separate UL and DL traffic, market preferences dictate that the majority of deployed systems will be FDD. This paper therefore describes LTE FDD systems only.

1.1 LTE Design Goals

The LTE PHY is designed to meet the following goals [1]:

1. Support scalable bandwidths of 1.25, 2.5, 5.0, 10.0 and 20.0 MHz
2. Peak data rate that scales with system bandwidth
 - a. Downlink (2 Ch MIMO) peak rate of 100 Mbps in 20 MHz channel
 - b. Uplink (single Ch Tx) peak rate of 50 Mbps in 20 MHz channel
3. Supported antenna configurations
 - a. Downlink: 4x2, 2x2, 1x2, 1x1
 - b. Uplink: 1x2, 1x1
4. Spectrum efficiency
 - a. Downlink: 3 to 4 x HSDPA Rel. 6
 - b. Uplink: 2 to 3 x HSUPA Rel. 6
5. Latency
 - a. C-plane: <50 – 100 msec to establish U-plane
 - b. U-plane: <10 msec from UE to server
6. Mobility
 - A. Optimized for low speeds (<15 km/hr)
 - B. High performance at speeds up to 120 km/hr
 - C. Maintain link at speeds up to 350 km/hr
7. Coverage
 - a. Full performance up to 5 km
 - b. Slight degradation 5 km – 30 km
 - c. Operation up to 100 km should not be precluded by standard

2 LTE Basic Concepts

Before jumping into a detailed description of the LTE PHY, it's worth taking a look at some of the basic technologies involved. Many methods employed in LTE are relatively new in cellular applications. These include OFDM, OFDMA, MIMO and Single Carrier Frequency Division Multiple Access (SC-FDMA). Readers familiar with these technologies can skip this material and proceed directly to Section 3.

LTE employs OFDM for downlink data transmission and SC-FDMA for uplink transmission. OFDM is a well-known modulation technique, but is rather novel in cellular applications. A brief discussion of the basic properties and advantages of this method is therefore warranted.

When information is transmitted over a wireless channel, the signal can be distorted due to multipath. Typically (but not always) there is a line-of-sight path between the transmitter and receiver. In addition, there are many other paths created by signal reflection off buildings, vehicles and other obstructions as shown in Figure 2.0-1. Signals traveling along these paths all reach the receiver, but are shifted in time by an amount corresponding to the differences in the distance traveled along each path.

2.1 Single Carrier Modulation and Channel Equalization

To date, cellular systems have used single carrier modulation schemes almost exclusively. Although LTE uses OFDM rather than single carrier modulation, it's instructive to briefly discuss how single carrier systems deal with multipath-induced channel distortion. This will form a point of reference from which OFDM systems can be compared and contrasted.

The term delay spread describes the amount of time delay at the receiver from a signal traveling from the transmitter along different paths. In cellular applications, delay spreads can be several microseconds. The delay induced by multipath can cause a symbol received along a delayed path to "bleed" into a subsequent symbol arriving at the receiver via a more direct path. This effect is depicted in Figure 2.1-1 and is referred to as inter-symbol interference (ISI). In a conventional single carrier system symbol times decrease as data rates increase. At very high data rates (with correspondingly shorter symbol periods), it is quite possible for ISI to exceed an entire symbol period and spill into a second or third subsequent symbol.

Figure 2.0-1 Multipath is Caused by Reflections Off Objects Such as Buildings and Vehicles

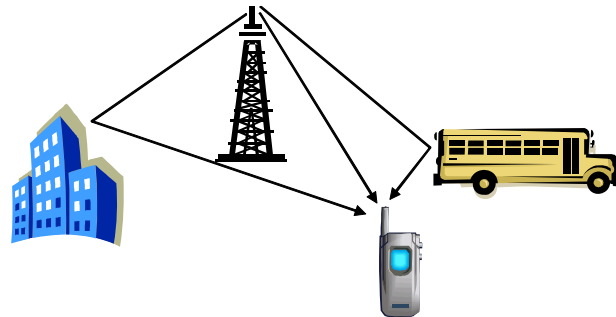
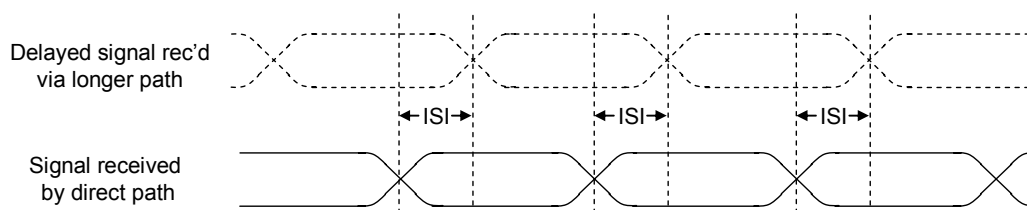
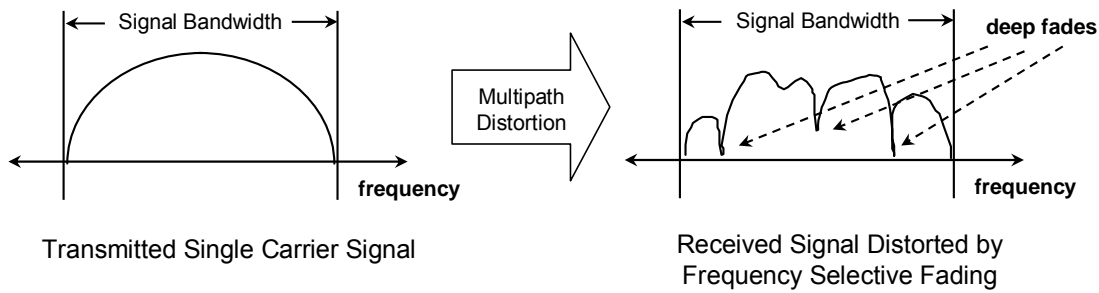

Figure 2.1-1 Multipath-Induced Time Delays Result in ISI



It's also helpful to consider the effects of multipath distortion in the frequency domain. Each different path length and reflection will result in a specific phase shift. As all of the signals are combined at the receiver, some frequencies within the signal passband undergo constructive interference (linear combination of signals in-phase), while others encounter destructive interference (linear combination of signals out-of-phase). The composite received signal is distorted by frequency selective fading (see Figure 2.1-2).

Figure 2.1-2 Longer Delay Spreads Result in Frequency Selective Fading



Single carrier systems compensate for channel distortion via time domain equalization. This is a substantial topic by itself, and beyond the scope of this paper. Generally, time domain equalizers compensate for multipath induced distortion by one of two methods:

1. Channel inversion: A known sequence is transmitted over the channel prior to sending information. Because the original signal is known at the receiver, a channel equalizer is able to determine the channel response and multiply the subsequent data-bearing signal by the inverse of the channel response to reverse the effects of multipath.
2. CDMA systems can employ rake equalizers to resolve the individual paths and then combine digital copies of the received signal shifted in time to enhance the receiver signal-to-noise ratio (SNR).

In either case, channel equalizer implementation becomes increasingly complex as data rates increase. Symbol times become shorter and receiver sample clocks must become correspondingly faster. ISI becomes much more severe—possibly spanning several symbol periods.

Figure 2.1-3 Transversal Filter Channel Equalizer

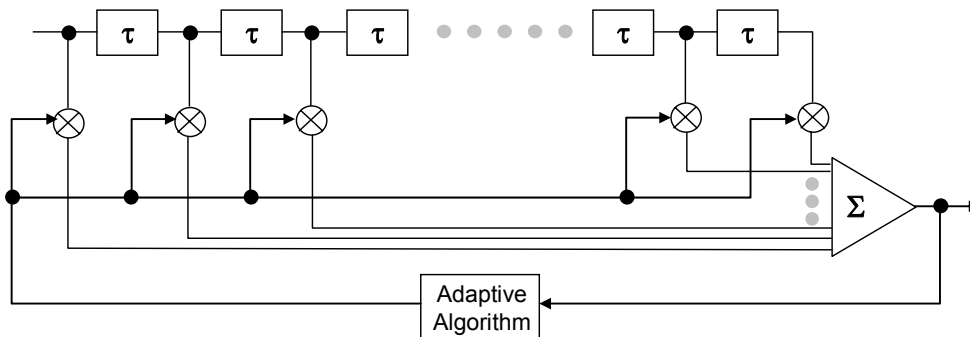

The finite impulse response transversal filter (see Figure 2.1-3) is a common equalizer topology. As the period of the receiver sample clock (τ) decreases, more samples are required to compensate for a given amount of delay spread. The number of delay taps increases along with the speed and complexity of the adaptive algorithm. For LTE data rates (up to 100 Mbps) and delay spreads (approaching 17 μ sec), this approach to channel equalization becomes impractical. As we will discuss below, OFDM eliminates ISI in the time domain, which dramatically simplifies the task of channel compensation.

2.2 OFDM

Unlike single carrier systems described above, OFDM communication systems do not rely on increased symbol rates in order to achieve higher data rates. This makes the task of managing ISI much simpler. OFDM systems break the available bandwidth into many narrower sub-carriers and transmit the data in parallel streams. Each subcarrier is modulated using varying levels of QAM modulation, e.g. QPSK, QAM, 64QAM or possibly higher orders depending on signal quality. Each OFDM symbol is therefore a linear combination of the instantaneous signals on each of the sub-

carriers in the channel. Because data is transmitted in parallel rather than serially, OFDM symbols are generally MUCH longer than symbols on single carrier systems of equivalent data rate.

There are two truly remarkable aspects of OFDM. First, each OFDM symbol is preceded by a cyclic prefix (CP), which is used to effectively eliminate ISI. Second, the sub-carriers are very tightly spaced to make efficient use of available bandwidth, yet there is virtually no interference among adjacent sub-carriers (Inter Carrier Interference, or ICI). These two unique features are actually closely related. In order to understand how OFDM deals with multipath distortion, it's useful to consider the signal in both the time and frequency domains.

To understand how OFDM deals with ISI induced by multipath, consider the time domain representation of an OFDM symbol shown in Figure 2.2-1. The OFDM symbol consists of two major components: the CP and an FFT period (T_{FFT}). The duration of the CP is determined by the highest anticipated degree of delay spread for the targeted application. When transmitted signals arrive at the receiver by two paths of differing length, they are staggered in time as shown in Fig. 2.2-2.

Figure 2.2-2 OFDM Eliminates ISI via Longer Symbol Periods and a Cyclic Prefix

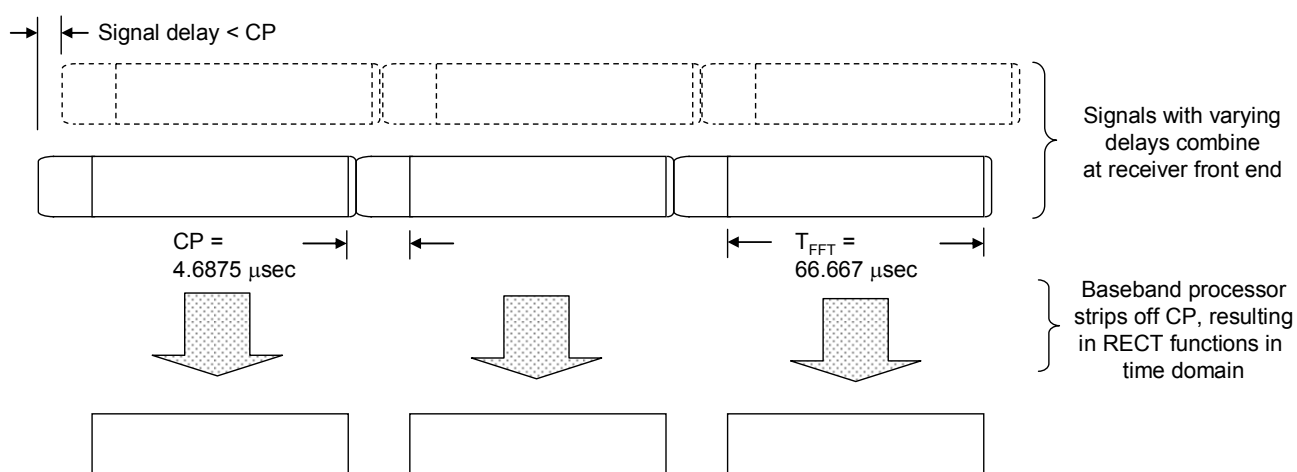

Within the CP, it is possible to have distortion from the preceding symbol. However, with a CP of sufficient duration, preceding symbols do not spill over into the FFT period; there is only interference caused by time-staggered “copies” of the current symbol. Once the channel impulse response is determined (by periodic transmission of known reference signals), distortion can be corrected by applying an amplitude and phase shift on a subcarrier-by-subcarrier basis.

Note that all of the information of relevance to the receiver is contained within the FFT period. Once the signal is received and digitized, the receiver simply throws away the CP. The result is a rectangular pulse that, within each subcarrier, is of constant amplitude over the FFT period.

The rectangular pulses resulting from decimation of the CP are central to the ability to space subcarriers very closely in frequency without creating ICI. Readers may recall that a uniform rectangular pulse (RECT function) in the time domain results in a SINC function ($\sin(x) / x$) in the frequency domain as shown in Fig. 2.2-3. The LTE FFT Period is 67.77 μsec. Note that this is simply the inversion of the carrier spacing ($1 / \Delta f$). This results in a SINC pattern in the frequency domain with uniformly spaced zero-crossings at 15 kHz intervals—precisely at the center of the adjacent subcarrier. It is therefore possible to sample at the center frequency of each subcarrier while encountering no interference from neighboring subcarriers (zero-ICI).

Figure 2.2-3 FFT of OFDM Symbol Reveals Distinct Subcarriers

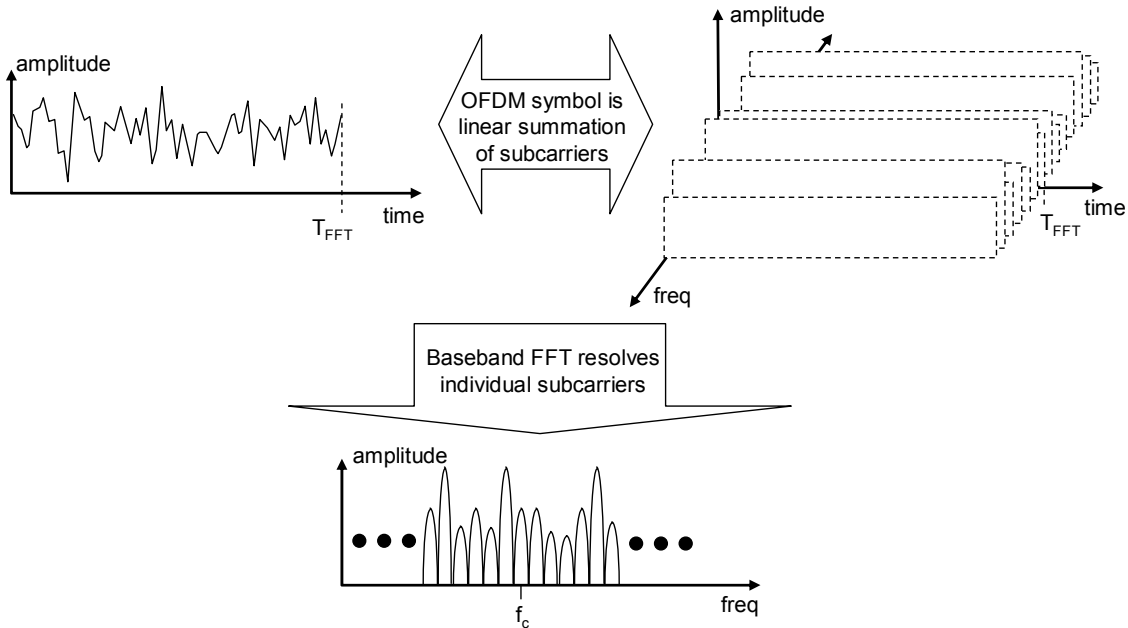

2.2.1 Disadvantages of OFDM

As we have seen, OFDM has some remarkable attributes. However, like all modulation schemes, it suffers from some drawbacks. OFDM has two principle weaknesses relative to single carrier systems: susceptibility to carrier frequency errors (due either to local oscillator offset or Doppler shifts) and a large signal peak-to-average power ratio (PAPR).

As discussed above, OFDM systems can achieve zero-ICI if each subcarrier is sampled precisely at its center frequency. The time-sampled OFDM signal is converted into the frequency domain by means of a fast Fourier transform (FFT)—which is a highly efficient means of implementing a discrete Fourier transform (DFT). The DFT renders a discrete finite sequence of complex coefficients which are given by:

$$X_k = \sum_{n=0}^{N-1} x_n e^{-j2\pi nk / N}, \quad k = 0, 1, \dots, N-1$$

The resulting Fourier spectrum has discrete frequencies at:

$$k/NT_s, \quad k = 0, 1, \dots, N-1$$

where T_s is the sample interval in the time domain and N is the number of samples. Thus, the frequencies in the Fourier representation are completely defined by the sample frequency ($1 / T_s$) and the number of samples taken within the FFT period.

Let's consider a specific LTE example. LTE defines transmission bandwidths from 1.25 MHz up to 20 MHz. In the case of 1.25 MHz transmission bandwidth, the FFT size is 128. In other words, 128 samples are taken within the FFT period of 66.67 μ sec. Therefore, $T_s = 0.52086 \mu$ sec, and the received signal is represented by frequencies at 15 kHz, 30 kHz, 45 kHz... These frequencies are the exact center frequencies of the signal subcarriers—unless frequency errors are encountered in the downconversion process.

The FFT is done at baseband frequency, after the received signal has been downconverted from the RF carrier frequency. Downconversion is typically performed by means of direct conversion. The received signal is mixed with a signal produced by the receiver's local oscillator (LO). Ideally, the carrier signal and the receiver LO are at the identical frequency. Unfortunately, this is not always the case.

The transmitter and receiver local oscillators will invariably drift, so active means must be taken to keep them synchronized. Each base station periodically sends synchronization signals which are used by the UE for this purpose, among other things (synchronization signals are also used for initial acquisition and handover). Even so, other sources

such as Doppler shifts and oscillator phase noise can still result in frequency errors. Uncorrected frequency errors will result in ICI as shown in Figure 2.2.1-1. For these reasons, the signal frequency must be tracked continuously. Any offsets must be corrected in the baseband processor to avoid excessive ICI that might result in dropped packets.

Figure 2.2.1.1 Uncorrected Frequency Errors Cause ICI

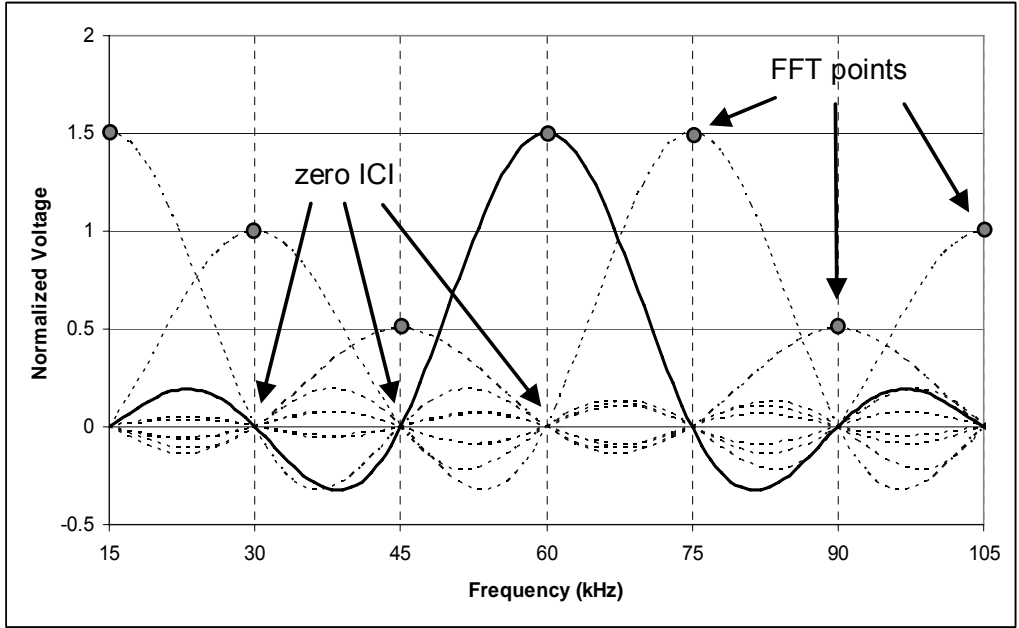

Demodulated Signal without Frequency Offset (Zero ICI)

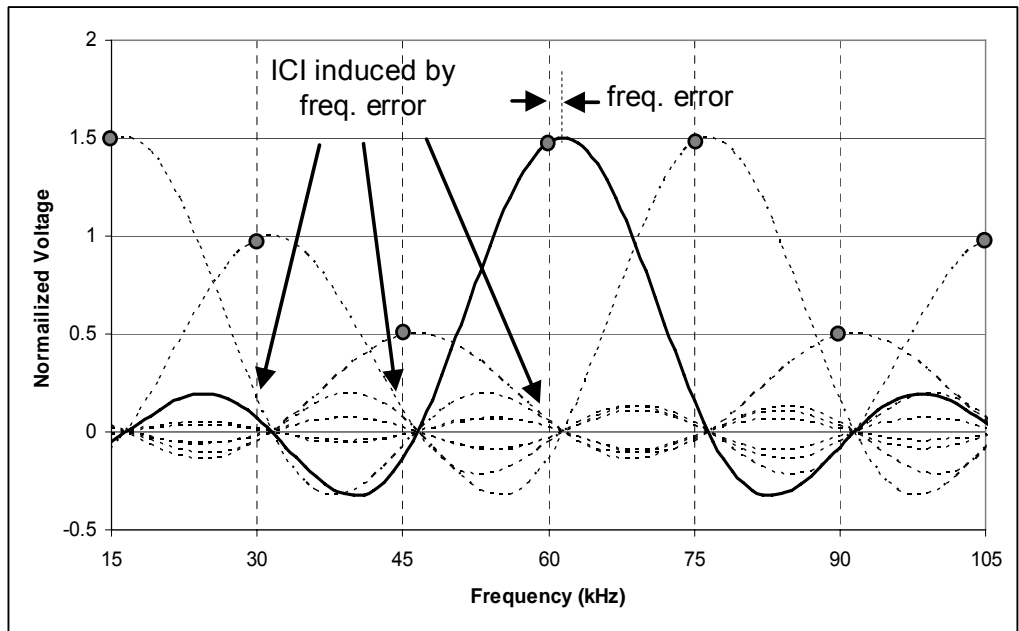

Demodulated Signal with Frequency Offset Causing ICI

The other major drawback to OFDM is a high PAPR. The instantaneous transmitted RF power can vary dramatically within a single OFDM symbol. As stated above, the OFDM symbol is a combination of all of the subcarriers. Subcarrier

voltages can add in-phase at some points within the symbol, resulting in very high instantaneous peak power—much higher than the average power.

A high PAPR drives dynamic range requirements for A/D and D/A converters. Even more importantly, it also reduces efficiency of the transmitter RF power amplifier (RFPA). Single carrier systems sometimes use constant envelope modulation methods, such as Gaussian Minimum Shift Keying (GMSK) or Phase Shift Keying (PSK). The information in the signal of a single carrier system is conveyed by varying the instantaneous frequency or phase while the signal amplitude remains constant. The RFPA does not require a high degree of linearity. In fact, the PA can be driven so hard that the signal is “clipped” as the signal swings between the minimum and maximum voltages. Harmonic distortion due to clipping can be eliminated by output filtering. When RFPAs are operated in this manner, they can achieve efficiencies on the order of 70 percent.

In contrast, OFDM is not a constant envelope modulation scheme. Within each symbol, the amplitude and phase of each sub-carrier is constant. Over the duration of an OFDM symbol, there can be several large peaks. The RFPA must be capable of handling peak voltage swings without clipping, thus requiring a larger amplifier to handle a given average power. Efficiency is therefore lower. RFPA efficiencies for OFDM signals can be less than 20 percent. Although there are measures that can be taken to reduce voltage peaks, PAPR for OFDM results in RFPA efficiencies that are generally lower than for single-carrier constant envelope systems.

2.3 OFDMA

OFDMA is employed as the multiplexing scheme in the LTE downlink. Perhaps the best way to describe OFDMA is by contrasting it with a packet-oriented networking scheme such as 802.11a. In 802.11a, Carrier-Sense Multiple Access (CSMA) is the multiplexing method. Downlink and uplink traffic from the fixed access point (AP) to mobile user stations (STAs) is by means of PHY layer packets. As explained below, OFDMA makes much more efficient use of network resources.

2.3.1 Comparison of OFDMA with Packet-Oriented Protocols

Like 3GPP LTE, IEEE 802.11a uses OFDM as the underlying modulation method. However, 802.11a uses CSMA as the multiplexing method. CSMA is essentially a listen-before-talk scheme. For example, when the AP has queued traffic for a STA, it monitors the channel for activity. When the channel becomes idle, it begins to decrement an internal timer that is randomized within a specified window. The timer will continue to be decremented as long as the network remains idle. When the timer reaches zero, the AP will transmit a PHY layer packet of up to 2000 bytes addressed to a particular STA (or all STAs within the cell in the case of broadcast mode). The randomized back-off period is designed to minimize collisions, but it cannot eliminate them entirely.

Figure 2.3.1-1 Conventional Packet Oriented Networks Like IEEE 802.11a Precede Each Data Transmission with a PHY Layer Preamble and Header

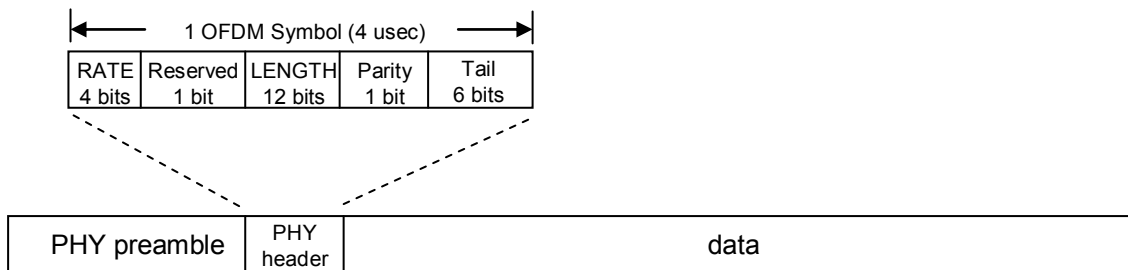

Each 802.11a PHY packet utilizes all of the PHY layer bandwidth for the duration of the packet. Consider the 802.11a PHY packet format shown in Figure 2.3.1-1. Each 802.11a packet has a data payload of varying length from 64 to 2048 bytes. If the packet transmission is successful, the receiving station transmits an ACK. Unacknowledged packets are assumed to be dropped. Note that each packet is preceded by a PHY preamble which is 20 μsec in duration. The purposes of the PHY preamble are:

- Signal detection
- Antenna diversity selection

- Setting AGC
- Frequency offset estimation
- Timing synchronization
- Channel estimation

The address of the intended recipient is not in the PHY preamble. It is actually in the packet data and is interpreted at the MAC layer. From a networking perspective, the packet-oriented approach of 802.11a has the advantage of simplicity. Each packet is addressed to a single recipient (broadcast mode notwithstanding). However, the randomized backoff period of the CSMA multiplexing scheme is idle time and therefore represents an inefficiency. The PHY preamble is also network overhead and further reduces efficiency, particularly for shorter packets.

The typical real-world efficiency of an 802.11a system is approximately 50 percent. In other words, for a network with a nominal data rate of 54 Mbps, the typical throughput is about 25 – 30 Mbps. Some of the inefficiencies can be mitigated by abandoning the CSMA multiplexing scheme and adopting a scheduled approach to packet transmission. Indeed, subsequent versions of the 802.11 protocol include this feature. Inefficiencies due to dedicated ACK packets can also be reduced by acknowledging packets in groups rather than individually.

In spite of potential improvements, it remains difficult to drive packet-oriented network efficiency much beyond 65 to 70 percent. Further, because each packet completely consumes all network resources during transmission and acknowledgement, the AP can provide addressed (non-broadcast) traffic to user terminals only on a sequential basis. When many users are active within the cell, latency can become a significant problem. Clearly, the objective of cellular carriers is to create as much network demand as possible for a wide variety of traffic that includes voice, multimedia, and data. Efficiency and low latency are therefore paramount. As we will see in the following section, OFDMA is superior to packet-oriented schemes in both of these critical dimensions.

2.3.2 OFDMA and the LTE Generic Frame Structure

OFDMA is an excellent choice of multiplexing scheme for the 3GPP LTE downlink. Although it involves added complexity in terms of resource scheduling, it is vastly superior to packet-oriented approaches in terms of efficiency and latency. In OFDMA, users are allocated a specific number of subcarriers for a predetermined amount of time. These are referred to as physical resource blocks (PRBs) in the LTE specifications. PRBs thus have both a time and frequency dimension. Allocation of PRBs is handled by a scheduling function at the 3GPP base station (eNodeB).

Figure 2.3.2-1 LTE Generic Frame Structure

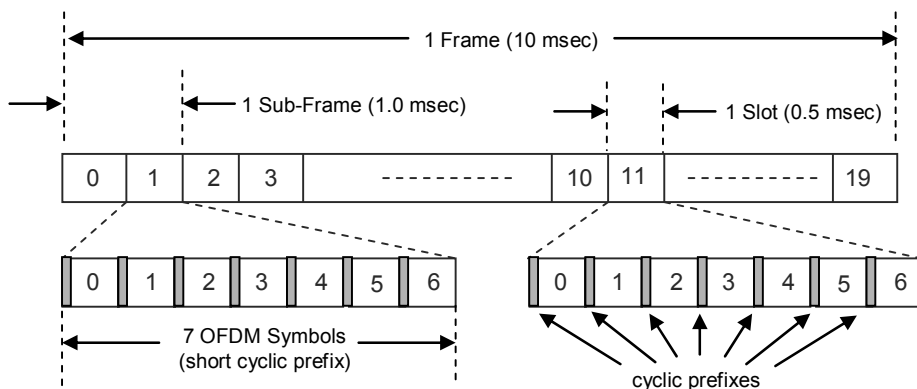

In order to adequately explain OFDMA within the context of the LTE, we must study the PHY layer generic frame structure. The generic frame structure is used with FDD. Alternative frame structures are defined for use with TDD. However, TDD is beyond the scope of this paper. Alternative frame structures are therefore not considered.

As shown in figure 2.3.2-1, LTE frames are 10 msec in duration. They are divided into 10 subframes, each subframe being 1.0 msec long. Each subframe is further divided into two slots, each of 0.5 msec duration. Slots consist of either 6 or 7 OFDM symbols, depending on whether the normal or extended cyclic prefix is employed.

Table 2.3.2-1 Available Downlink Bandwidth is Divided into Physical Resource Blocks

| Bandwidth (MHz) | 1.25 | 2.5 | 5.0 | 10.0 | 15.0 | 20.0 |
|---|------|-----|-----|------|------|------|
| Subcarrier bandwidth (kHz) | 15 | | | | | |
| Physical resource block (PRB) bandwidth (kHz) | 180 | | | | | |
| Number of available PRBs | 6 | 12 | 25 | 50 | 75 | 100 |

The total number of available subcarriers depends on the overall transmission bandwidth of the system. The LTE specifications define parameters for system bandwidths from 1.25 MHz to 20 MHz as shown in Table 2.3.2-1. A PRB is defined as consisting of 12 consecutive subcarriers for one slot (0.5 msec) in duration. A PRB is the smallest element of resource allocation assigned by the base station scheduler.

Figure 2.3.2-2 Downlink Resource Grid

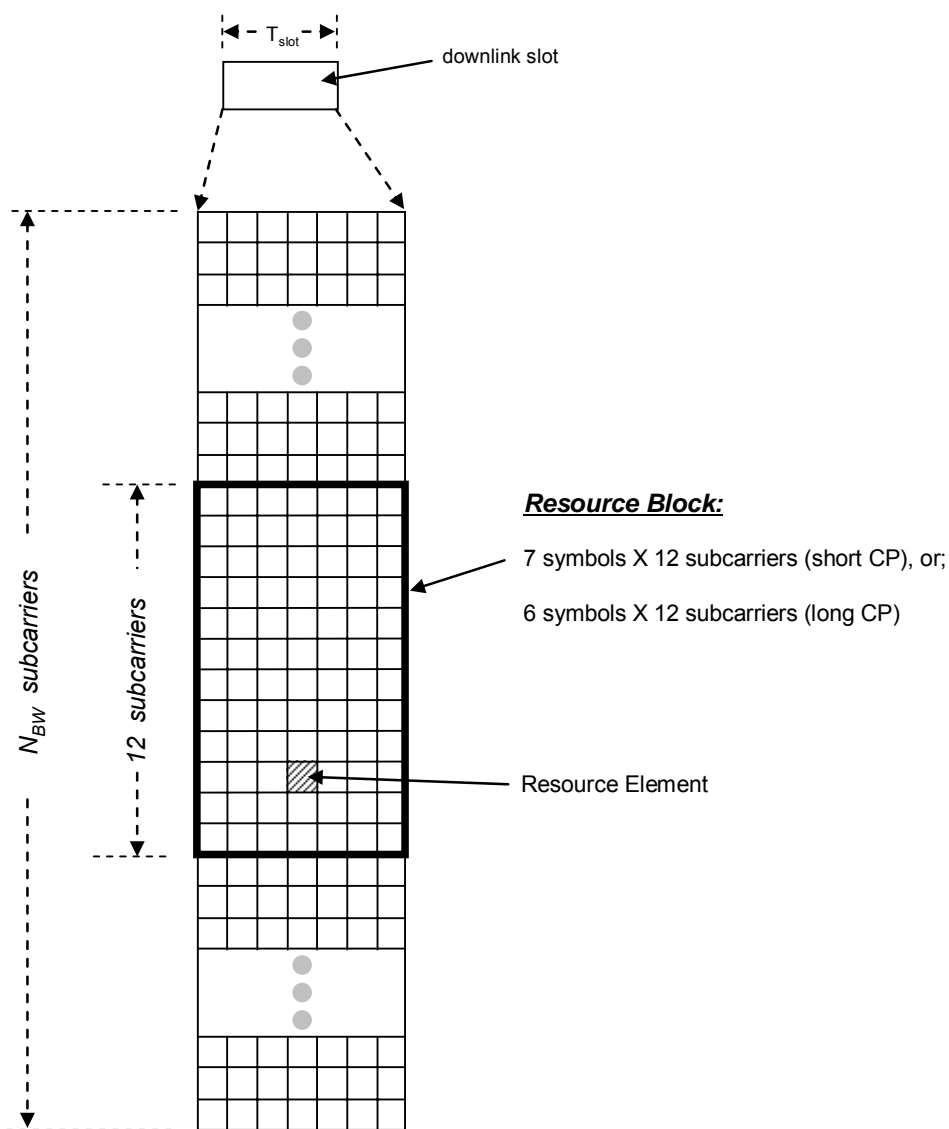

The transmitted downlink signal consists of N_{BW} subcarriers for a duration of N_{symbol} OFDM symbols. It can be represented by a *resource grid* as depicted in Figure 2.3.2-2. Each box within the grid represents a single subcarrier for one symbol period and is referred to as a *resource element*. Note that in MIMO applications, there is a resource grid for each transmitting antenna.

In contrast to packet-oriented networks, LTE does not employ a PHY preamble to facilitate carrier offset estimate, channel estimation, timing synchronization etc. Instead, special reference signals are embedded in the PRBs as shown in Figure 2.3.2-3. Reference signals are transmitted during the first and fifth OFDM symbols of each slot when the short CP is used and during the first and fourth OFDM symbols when the long CP is used.

Figure 2.3.2-3 LTE Reference Signals are Interspersed Among Resource Elements

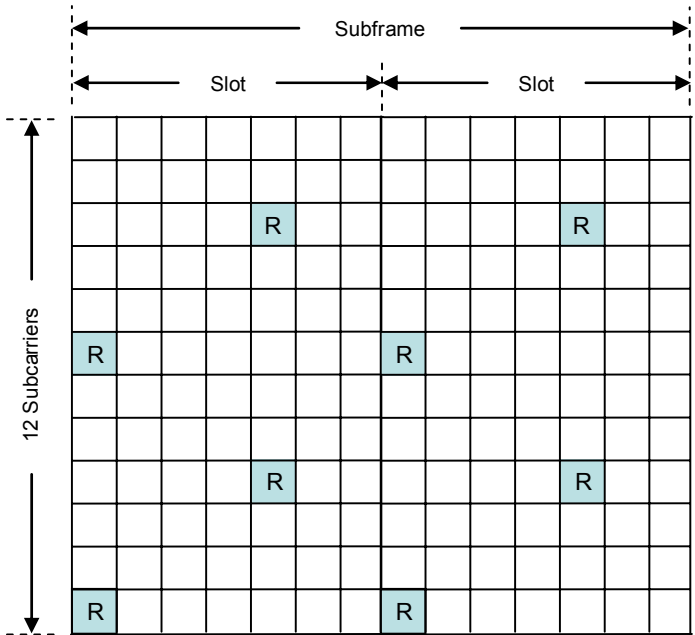

Note that reference symbols are transmitted every sixth subcarrier. Further, reference symbols are staggered in both time and frequency. The channel response on subcarriers bearing the reference symbols can be computed directly. Interpolation is used to estimate the channel response on the remaining subcarriers.

2.4 MIMO and MRC

The LTE PHY can optionally exploit multiple transceivers at both the basestation and UE in order to enhance link robustness and increase data rates for the LTE downlink. In particular, maximal ratio combining (MRC) is used to enhance link reliability in challenging propagating conditions when signal strength is low and multipath conditions are challenging. MIMO is a related technique that is used to increase system data rates.

Figure 2.4-1a MRC/MIMO Operation Requires Multiple Transceivers

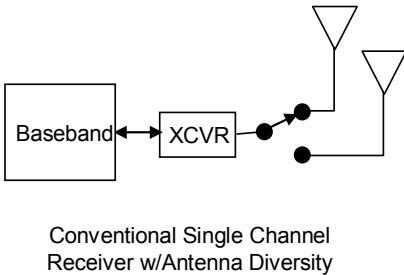

Figure 2.4-1b MRC/MIMO Receiver Configuration (2-ch)

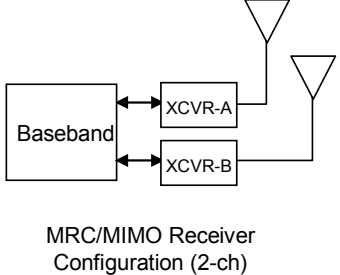
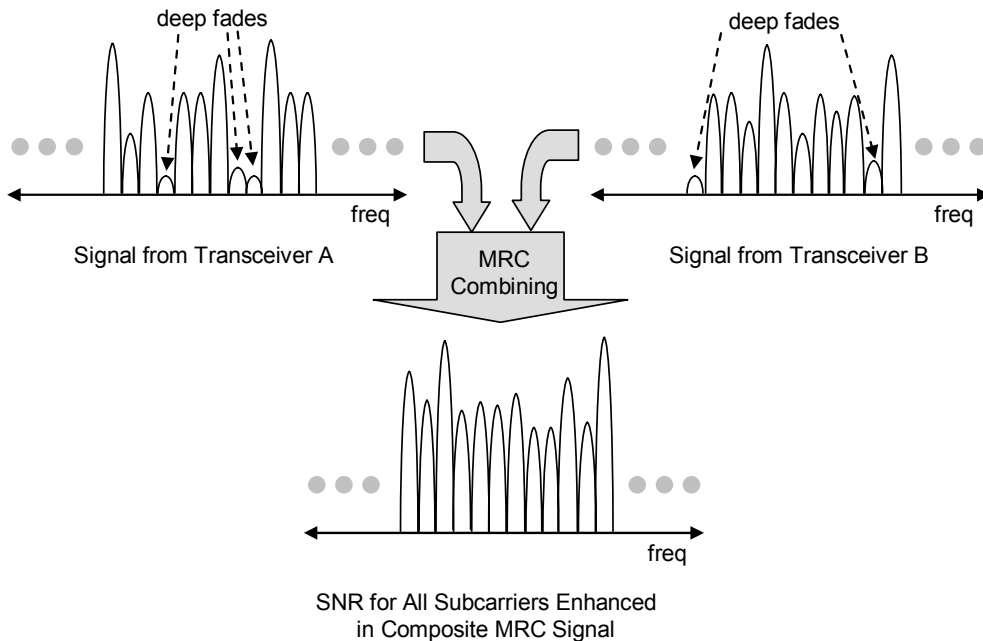

Figure 2.4-1a shows a conventional single channel receiver with antenna diversity. This receiver structure uses multiple antennas, but it is not capable of supporting MRC/MIMO. The basic receiver topology for both MRC and MIMO is shown in Figure 2.4-1b. MRC and MIMO are sometimes referred to as “multiple antenna” technologies, but this is a bit of a misnomer. Note that the salient difference between the receivers shown in Figures 2.4-1a and 2.4-1b is not multiple antennas, but rather multiple transceivers.

With MRC, a signal is received via two (or more) separate antenna/transceiver pairs. Note that the antennas are physically separated, and therefore have distinct channel impulse responses. Channel compensation is applied to each received signal within the baseband processor before being linearly combined to create a single composite received signal.

When combined in this manner, the received signals add coherently within the baseband processor. However, the thermal noise from each transceiver is uncorrelated. Thus, linear combination of the channel compensated signals at the baseband processor results in an increase in SNR of 3 dB on average for a two-channel MRC receiver in a noise-limited environment.

Fig. 2.4-2 MRC Enhances Reliability in the Presence of AWGN and Frequency Selective Fading



Aside from the improvement in SNR due to combining, MRC receivers are robust in the presence of frequency selective fading. Recall that physical separation of the receiver antennas results in distinct channel impulse responses for each receiver channel. In the presence of frequency selective fading, it is statistically unlikely that a given subcarrier will undergo deep fading on *both* receiver channels. The possibility of deep frequency selective fades in the composite signal is therefore significantly reduced.

MRC enhances link reliability, but it does not increase the nominal system data rate. In MRC mode, data is transmitted by a single antenna and is processed at the receiver via two or more receivers. MRC is therefore a form of *receiver diversity* rather than more conventional *antenna diversity*. MIMO, on the other hand, does increase system data rates. This is achieved by using multiple antennas on both the transmitting and receiving ends.

Figure 2.4-3 Reference Signals Transmitted Sequentially to Compute Channel Responses for MIMO Operation

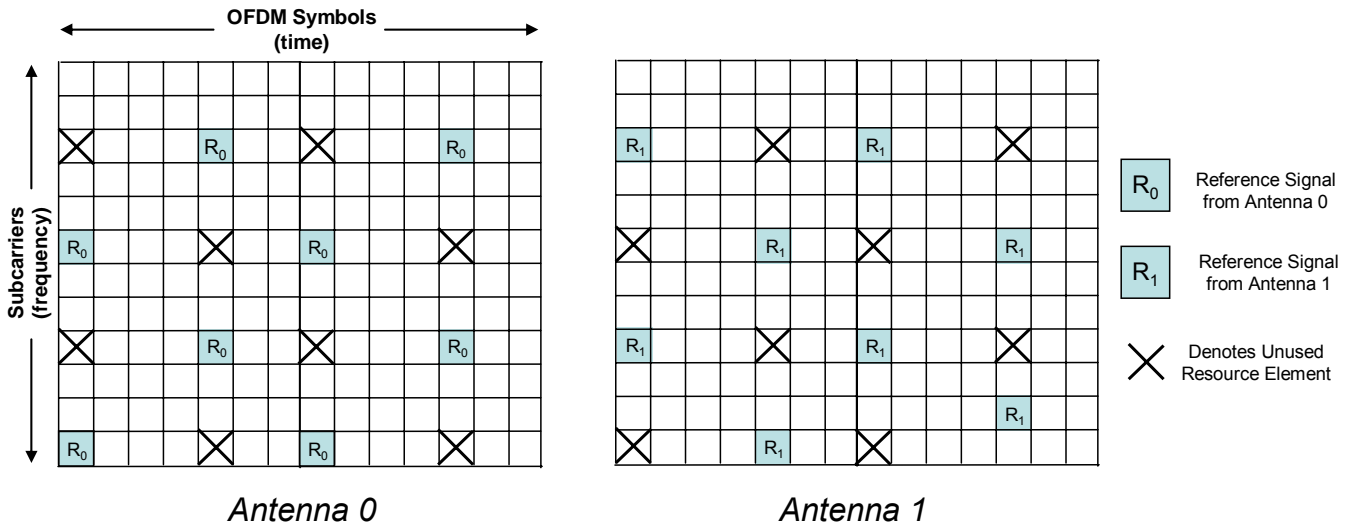

In order to successfully receive a MIMO transmission, the receiver must determine the channel impulse response from each transmitting antenna. In LTE, channel impulse responses are determined by sequentially transmitting known reference signals from each transmitting antenna as shown in Figure 2.4-3.

Figure 2.4-4 MIMO Operation Requires A Priori Knowledge of all Channel Responses

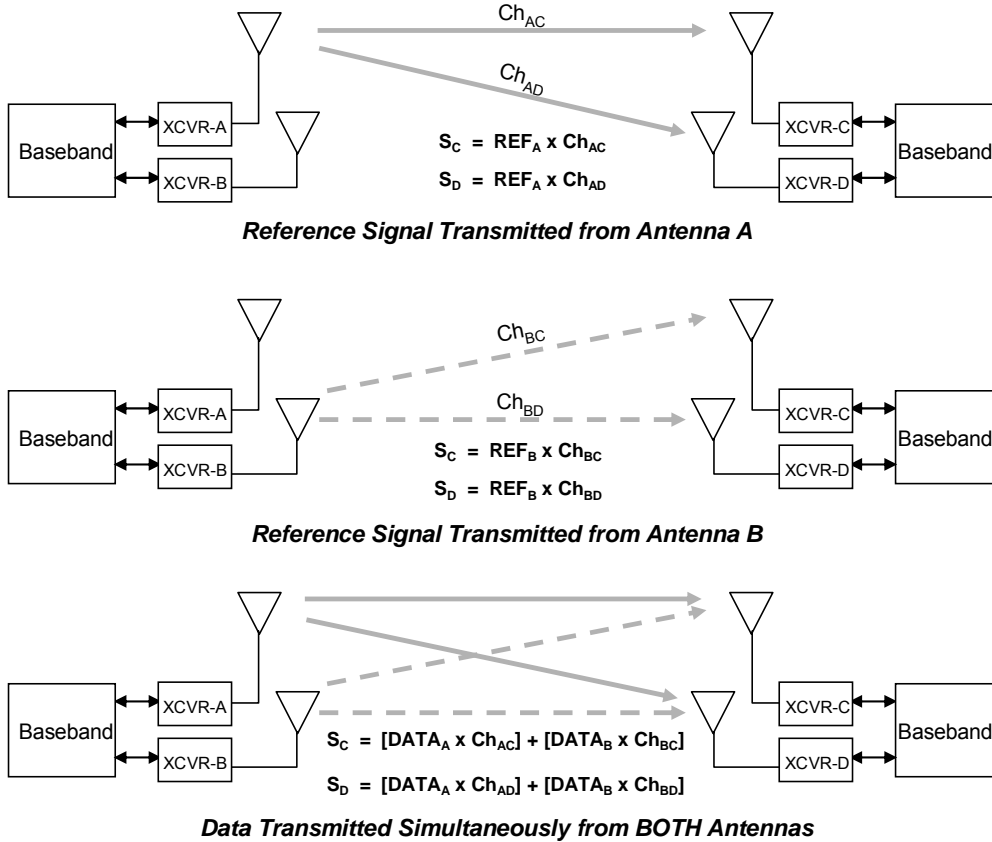

Referring to the 2 x 2 MIMO system in Figure 2.4-4, there are a total of four channel impulse responses (C_1, C_2, C_3 and C_4). Note that while one transmitter antenna is sending the reference signal, the other antenna is idle. Once the channel

impulse responses are known, data can be transmitted from both antennas simultaneously. The linear combination of the two data streams at the two receiver antennas results in a set of two equations and two unknowns, which is resolvable into the two original data streams.

2.5 SC-FDMA

LTE uplink requirements differ from downlink requirements in several ways. Not surprisingly, power consumption is a key consideration for UE terminals. The high PAPR and related loss of efficiency associated with OFDM signaling are major concerns. As a result, an alternative to OFDM was sought for use in the LTE uplink.

Single Carrier – Frequency Domain Multiple Access (SC-FDMA) is well suited to the LTE uplink requirements. The basic transmitter and receiver architecture is very similar (nearly identical) to OFDMA, and it offers the same degree of multipath protection. Importantly, because the underlying waveform is essentially single-carrier, the PAPR is lower.

Fig. 2.5-1 SC-FDMA and OFDMA Signal Chains Have a High Degree of Functional Commonality

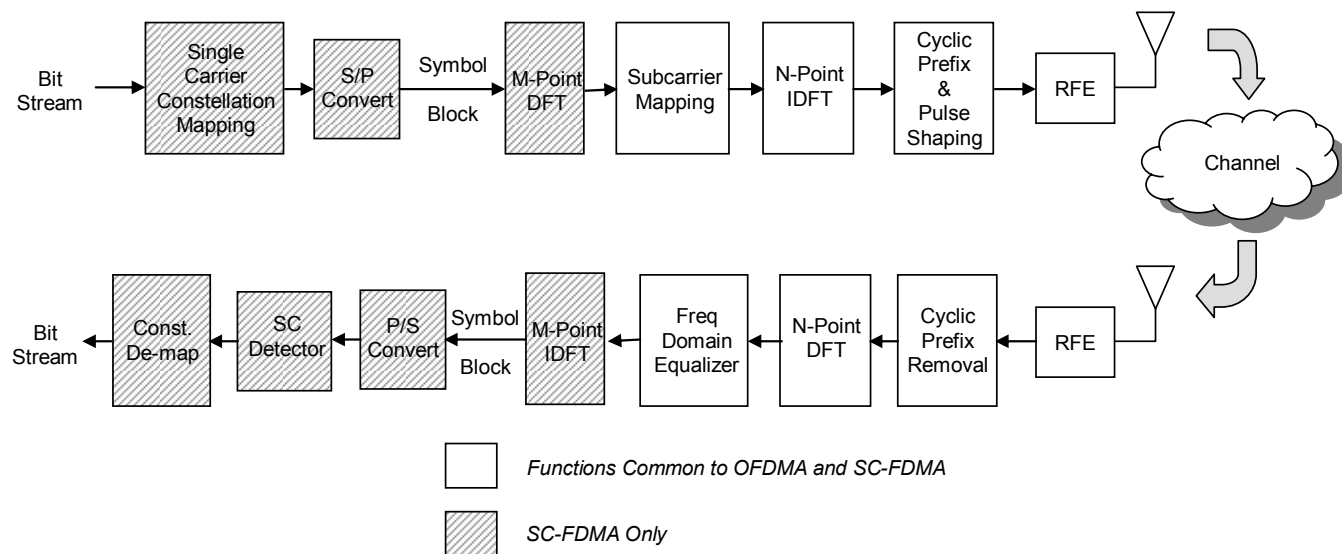

The block diagram of Figure 2.5-1 shows a basic SC-FDMA transmitter / receiver arrangement. Note that many of the functional blocks are common to both SC-FDMA and OFDMA, thus there is a significant degree of functional commonality between the uplink and downlink signal chains. The functional blocks in the transmit chain are:

1. **Constellation mapper:** Converts incoming bit stream to single carrier symbols (BPSK, QPSK, or 16QAM depending on channel conditions)
2. **Serial/parallel converter:** Formats time domain SC symbols into blocks for input to FFT engine
3. **M-point DFT:** Converts time domain SC symbol block into M discrete tones
4. **Subcarrier mapping:** Maps DFT output tones to specified subcarriers for transmission. SC-FDMA systems either use contiguous tones (localized) or uniformly spaced tones (distributed) as shown in Figure 2.5-2. The current working assumption in LTE is that localized subcarrier mapping will be used. The trades between localized and distributed subcarrier mapping are discussed further below.
5. **N-point IDFT:** Converts mapped subcarriers back into time domain for transmission
6. **Cyclic prefix and pulse shaping:** Cyclic prefix is pre-pended to the composite SC-FDMA symbol to provide multipath immunity in the same manner as described for OFDM. As in the case of OFDM, pulse shaping is employed to prevent spectral regrowth.
7. **RFE:** Converts digital signal to analog and upconvert to RF for transmission

In the receive side chain, the process is essentially reversed. As in the case of OFDM, SC-FDMA transmissions can be thought of as linear summations of discrete subcarriers. Multipath distortion is handled in the same manner as in OFDM

systems (removal of CP, conversion to the frequency domain, then apply the channel correction on a subcarrier-by-subcarrier basis).

Unlike OFDM, the underlying SC-FDMA signal represented by the discrete subcarriers is—not surprisingly—single carrier. This is distinctly different than OFDM because the SC-FDMA subcarriers are not independently modulated. As a result, PAPR is lower than for OFDM transmissions. Analysis has shown that the LTE UE RFPA can be operated about 2 dB closer to the 1-dB compression point than would otherwise be possible if OFDM were employed on the uplink [2].

2.5-2 SC-FDMA Subcarriers Can be Mapped in Either Localized or Distributed Mode

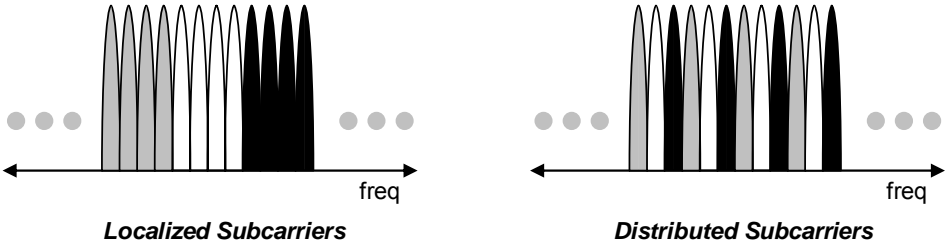

As mentioned above, SC-FDMA subcarriers can be mapped in one of two ways: localized or distributed as shown in Figure 2.5-2. However, the current working assumption is that LTE will use localized subcarrier mapping. This decision was motivated by the fact that with localized mapping, it is possible to exploit frequency selective gain via channel-dependent scheduling (assigning uplink frequencies to UE based on favorable propagation conditions).

3 LTE Physical Layer

The capabilities of the eNodeB and UE are obviously quite different. Not surprisingly, the LTE PHY DL and UL are quite different. The DL and UL are treated separately within the specification documents. Therefore, the DL and UL are described separately in the following sections.

3.0.1 Generic Frame Structure

One element shared by the LTE DL and UL is the generic frame structure. As mentioned previously, the LTE specifications define both FDD and TDD modes of operation. This paper deals exclusively with describing FDD specifications. The generic frame structure applies to both the DL and UL for FDD operation. It is described in detail Section 2.3.2 above, and the main points are repeated in this section.

Figure 3.0.1-1 LTE Generic Frame Structure

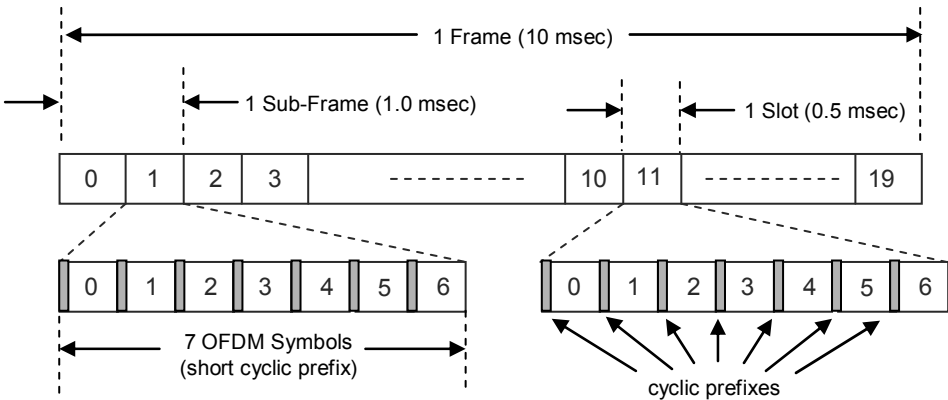

As described in Section 2.3.2, LTE transmissions are segmented into frames, which are 10 msec in duration. Frames consist of 20 slot periods of 0.5 msec. Sub-frames contain two slot periods and are 1.0 msec in duration.

3.1 Downlink

The LTE PHY specification is designed to accommodate bandwidths from 1.25 MHz to 20 MHz. OFDM was selected as the basic modulation scheme because of its robustness in the presence of severe multipath fading. Downlink multiplexing is accomplished via OFDMA.

The DL supports physical channels, which convey information from higher layers in the LTE stack, and physical signals which are for the exclusive use of the PHY layer. Physical channels map to transport channels, which are service access points (SAPs) for the L2/L3 layers. Depending on the assigned task, physical channels and signals use different modulation and coding parameters.

3.1.1 Modulation Parameters

OFDM is the modulation scheme for the DL. The basic subcarrier spacing is 15 kHz, with a reduced subcarrier spacing of 7.5 kHz available for some MB-SFN scenarios. Table 3.1.1-1 summarizes OFDM modulation parameters.

Table 3.1.1-1 Downlink OFDM Modulation Parameters

| Transmission BW | | 1.25 MHz | 2.5 MHz | 5 MHz | 10 MHz | 15 MHz | 20 MHz |
|-----------------------------------|-------|--------------------------------|---------------------------------|---------------------------------|---------------------------------|-----------------------------------|-----------------------------------|
| Sub-frame duration | | 0.5 ms | | | | | |
| Sub-carrier spacing | | 15 kHz | | | | | |
| Sampling frequency | | 192 MHz (1/2 x 3.84 MHz) | 3.84 MHz | 7.68 MHz (2 x 3.84 MHz) | 15.36 MHz (4 x 3.84 MHz) | 23.04 MHz (6 x 3.84 MHz) | 30.72 MHz (8 x 3.84 MHz) |
| FFT size | | 128 | 256 | 512 | 1024 | 1536 | 2048 |
| OFDM sym per slot (short/long CP) | | 7/6 | | | | | |
| CP length (usec/samples) | Short | (4.69/9) x 6, (5.21/10) x 1 | (4.69/18) x 6, (5.21/20) x 1 | (4.69/36) x 6, (5.21/40) x 1 | (4.69/72) x 6, (5.21/80) x 1 | (4.69/108) x 6, (5.21/120) x 1 | (4.69/144) x 6, (5.21/160) x 1 |
| | Long | (16.67/32) | (16.67/64) | (16.67/128) | (16.67/256) | (16.67/384) | (16.67/512) |

Depending on the channel delay spread, either short or long CP is used. When short CP is used, the first OFDM symbol in a slot has slightly longer CP than the remaining six symbols, as shown in Table 3.1.1-2. This is done to preserve slot timing (0.5 msec).

Table 3.1.1-2 Cyclic Prefix Duration

| Configuration | | Cyclic Prefix Length | |
|---------------|-----------------------------|----------------------------|-----------------------------|
| | | T_s | μsec |
| Normal CP | $\Delta f = 15 \text{ kHz}$ | 160 for $l = 0$ | 5.21 for $l = 0$ |
| | | 144 for $l = 1, 2 \dots 5$ | 4.69 for $l = 1, 2 \dots 5$ |
| Extended CP | $\Delta f = 15 \text{ kHz}$ | 512 | 16.67 |
| | $\Delta f = 15 \text{ kHz}$ | 1024 | 33.33 |

Note that the CP duration is described in absolute terms (e.g. 16.67 μ sec for long CP) and in terms of standard time units, T_s . T_s is used throughout the LTE specification documents. It is defined as $T_s = 1 / (15000 \times 2048)$ seconds, which corresponds to the 30.72 MHz sample clock for the 2048 point FFT used with the 20 MHz system bandwidth.

3.1.2 Downlink Multiplexing

OFDMA is the basic multiplexing scheme employed in the LTE downlink. OFDMA is a new-to-cellular technology and is described in detail in Section 2.3.2 above. As described in Section 2.3.2, groups of 12 adjacent subcarriers are grouped together on a slot-by-slot basis to form physical resource blocks (PRBs). A PRB is the smallest unit of bandwidth assigned by the base station scheduler.

Referring to Figure 2.3.2-2, a two dimensional (time and frequency) resource grid can be constructed to represent the transmitted downlink signal. Each block in the grid represents one OFDM symbol on a given subcarrier and is referred to as a resource element. Note that in MIMO applications, there is one resource grid for each transmitting antenna.

3.1.3 Physical Channels

Three different types of physical channels are defined for the LTE downlink. One common characteristic of physical channels is that they all convey information from higher layers in the LTE stack. This is in contrast to physical signals, which convey information that is used exclusively within the PHY layer.

LTE DL physical channels are:

- Physical Downlink Shared Channel (PDSCH)
- Physical Downlink Control Channel (PDCCH)
- Common Control Physical Channel (CCPCH)

Physical channels are mapped to specific transport channels as described in Section 3.1.5 below. Transport channels are SAPs for higher layers. Each physical channel has defined algorithms for:

- Bit scrambling
- Modulation
- Layer mapping
- CDD precoding
- Resource element assignment

Layer mapping and pre-coding are related to MIMO applications. Basically, a *layer* corresponds to a spatial multiplexing channel. MIMO systems are defined in terms of $N_{\text{transmitters}} \times N_{\text{receivers}}$. For LTE, defined configurations are 1x 1, 2 x 2, 3 x 2 and 4 x 2. Note that while there are as many as four transmitting antennas, there are only a maximum of two receivers and thus a maximum of only two spatial multiplexing data streams.

For a 1 x 1 or a 2 x 2 system, there is a simple 1:1 relationship between layers and transmitting antenna ports. However, for a 3 x 2 and 4 x 2 system, there are still only two spatial multiplexing channels. Therefore, there is redundancy on one or both data streams. Layer mapping specifies exactly how the extra transmitter antennas are employed.

Precoding is also used in conjunction with spatial multiplexing. Recall that MIMO exploits multipath to resolve independent spatial data streams. In other words, MIMO systems require a certain degree of multipath for reliable operation. In a noise-limited environment with low multipath distortion, MIMO systems can actually become impaired.

Physical Downlink Shared Channel

The PDSCH is utilized basically for data and multimedia transport. It therefore is designed for very high data rates. Modulation options therefore include QPSK, 16QAM and 64QAM. Spatial multiplexing is also used in the PDSCH. In fact, spatial multiplexing is exclusive to the PDSCH. It is not used on either the PDCCH or the CCPCH. Layer mapping for the PDSCH is described in Table 3.1.3-1.

Table 3.1.3-1 PDSCH Layer Mapping

| Transmission rank | Number of code words | Codeword-to-layer mapping |
|-------------------|----------------------|--|
| 1 | 1 | $x^{(0)}(i) = d^{(0)}(i)$ |
| 2 | 2 | $x^{(0)}(i) = d^{(0)}(i)$ $x^{(1)}(i) = d^{(1)}(i)$ |
| 3 | 2 | $d^{(0)}(i)$ is mapped to layer 0 $d^{(1)}(i)$ is mapped to layers 1 and 2 |
| 4 | 2 | $d^{(0)}(i)$ is mapped to layers 0 and 1 $d^{(1)}(i)$ is mapped to layers 2 and 3 |

Physical Downlink Control Channel

The PDCCH conveys UE-specific control information. Robustness rather than maximum data rate is therefore the chief consideration. QPSK is the only available modulation format. The PDCCH is mapped onto resource elements in up to the first three OFDM symbols in the first slot of a subframe.

Common Control Physical Channel

The CCPCH carries cell-wide control information. Like the PDCCH, robustness rather than maximum data rate is the chief consideration. QPSK is therefore the only available modulation format. In addition, the CCPCH is transmitted as close to the center frequency as possible. CCPCH is transmitted exclusively on the 72 active subcarriers centered on the DC subcarrier. Control information is mapped to resource elements (k, l) where k refers to the OFDM symbol within the slot and l refers to the subcarrier. CCPCH symbols are mapped to resource elements in increasing order of index k first, then l .

3.1.4 Physical Signals

Physical signals use assigned resource elements. However, unlike physical channels, physical signals do not convey information to/from higher layers. There are two types of physical signals:

- Reference signals used to determine the channel impulse response (CIR)
- Synchronization signals which convey network timing information

Reference Signals

Reference signals are generated as the product of an orthogonal sequence and a pseudo-random numerical (PRN) sequence. Overall, there are 510 unique reference signals possible. A specified reference signal is assigned to each cell within a network and acts as a cell-specific identifier.

Figure 2.1.4-1 Resource Element Mapping of Reference Signals

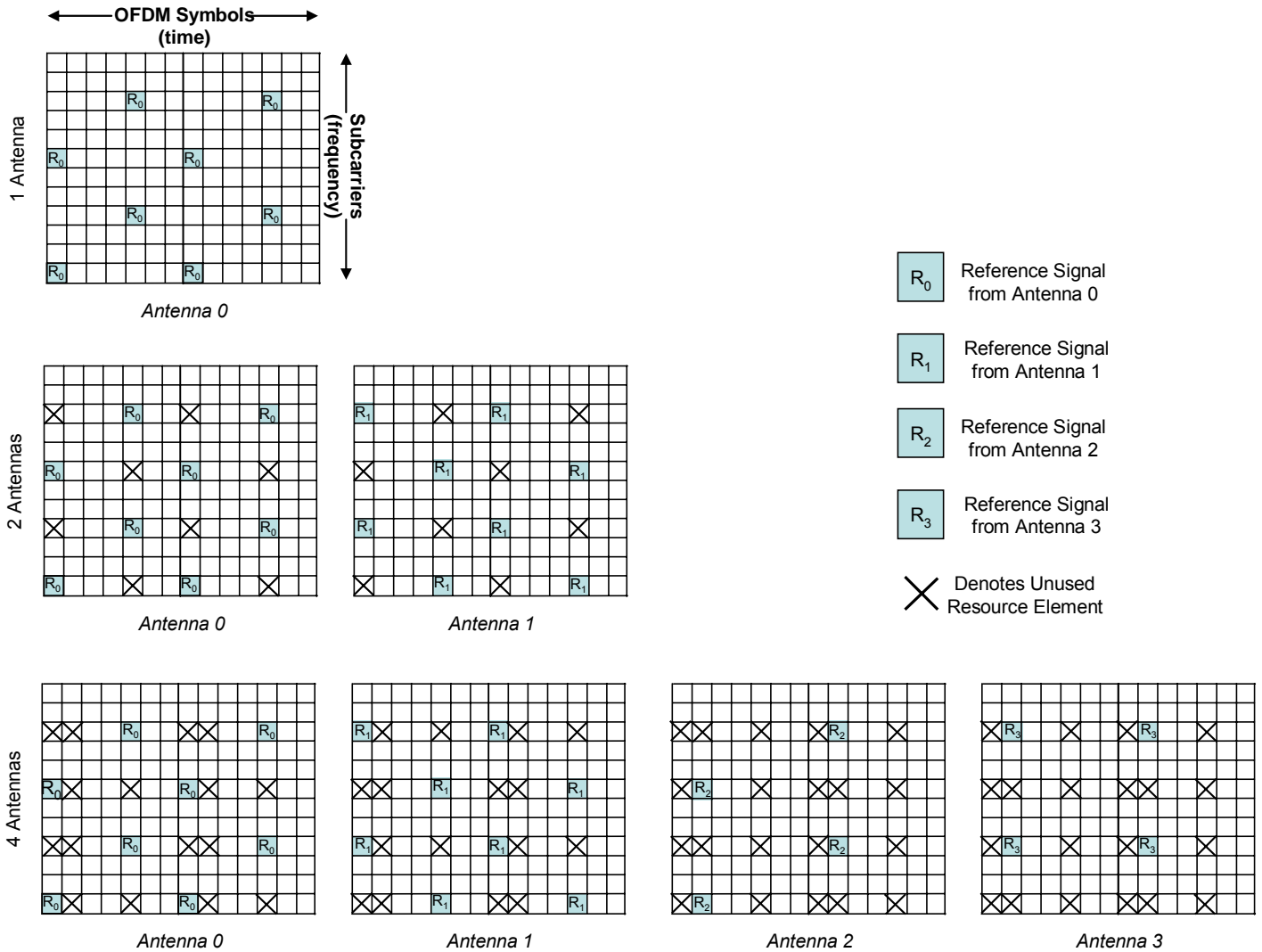

As shown in Figure 3.1.4-1, reference signals are transmitted on equally spaced subcarriers within the first and third-from-last OFDM symbol of each slot. UE must get an accurate CIR from each transmitting antenna. Therefore, when a reference signal is transmitted from one antenna port, the other antenna ports in the cell are idle.

Reference signals are sent on every sixth subcarrier. CIR estimates for subcarriers that do not bear reference signals are computed via interpolation. Changing the subcarriers that bear reference signals by pseudo-random frequency hopping is also under consideration.

Synchronization Signals

Synchronization signals use the same type of pseudo-random orthogonal sequences as reference signals. These are classified as primary and secondary synchronization signals, depending how they are used by UE during the cell search procedure. Both primary and secondary synchronization signals are transmitted on the 72 subcarriers centered around the DC subcarrier during the 0th and 10th slots of a frame (recall there are 20 slots within each frame).

3.1.5 Transport Channels

Transport channels are included in the LTE PHY and act as service access points (SAPs) for higher layers. Downlink Transport channels are:

Broadcast Channel (BCH)

- Fixed format
- Must be broadcast over entire coverage area of cell

Downlink Shared Channel (DL-SCH)

- Supports Hybrid ARQ (HARQ)
- Supports dynamic link adaption by varying modulation, coding and transmit power
- Suitable for transmission over entire cell coverage area
- Suitable for use with beamforming
- Support for dynamic and semi-static resource allocation
- Support for discontinuous receive (DRX) for power save

Paging Channel (PCH)

- Support for UE DRX
- Requirement for broadcast over entire cell coverage area
- Mapped to dynamically allocated physical resources

Multicast Channel (MCH)

- Requirement for broadcast over entire cell coverage area
- Support for MB-SFN
- Support for semi-static resource allocation

3.1.6 Mapping Downlink Physical Channels to Transport Channels

Transport channels are mapped to physical channels as shown in Figure 3.1.6-1. Supported transport channels are:

1. Broadcast channel (BCH)
2. Paging channel (PCH)
3. Downlink shared channel (DL-SCH)
4. Multicast channel (MCH)

Transport channels provide the following functions:

- Structure for passing data to/from higher layers
- Mechanism by which higher layers can configure the PHY
- Status indicators (packet error, CQI etc.) to higher layers
- Support for higher-layer peer-to-peer signaling

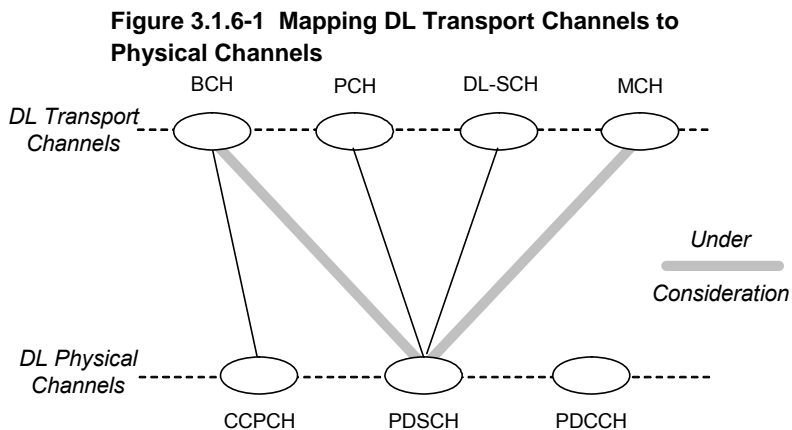

3.1.7 Downlink Channel Coding

Different coding algorithms are employed for the DL physical channels. For the common control channel (CCPCH), modulation is restricted to QPSK. The PDSCH uses up to 64 QAM modulation. For control channels, coverage is the paramount requirement. Convolutional coding has been selected for use with the CCPCH, though a final determination regarding code rate has not yet been made.

On the PDSCH, higher-complexity modulation is employed to achieve the highest possible downlink data rates. The PDSCH uses QPSK, 16QAM, or 64QAM depending on channel conditions. As a result, coding gain is emphasized over latency. Rate 1/3 turbo coding has been selected for the PDSCH.

3.2 Uplink

The LTE PHY uses Single Carrier - Frequency Division Multiple Access (SC-FDMA) as the basic transmission scheme for the uplink. The basic operating principles of SC-FDMA are described in Section 2.5 above. SC-FDMA is a misleading term, since SC-FDMA is essentially a multi-carrier scheme that re-uses many of the functional blocks included in the UE OFDM receiver signal chain (see Fig. 2.5-1). The principle advantage of SC-FDMA over conventional OFDM is a lower PAPR (by approximately 2 dB) than would otherwise be possible using OFDM.

3.2.1 Modulation Parameters

In FDD applications, the uplink uses the same generic frame structure (see Section 3.0.1) as the downlink. It also uses the same subcarrier spacing of 15 kHz and PRB width (12 subcarriers). Downlink modulation parameters (including normal and extended CP length) are identical to the uplink parameters shown in Tables 3.1.1-1 and 3.1.1-2. Subcarrier modulation is, however, much different.

In the uplink, data is mapped onto a signal constellation that can be QPSK, 16QAM, or 64QAM depending on channel quality. However, rather than using the QPSK/QAM symbols to directly modulate subcarriers (as is the case in OFDM), uplink symbols are sequentially fed into a serial/parallel converter and then into an FFT block as shown in Figure 2.5-1. The result at the output of the FFT block is a discrete frequency domain representation of the QPSK/QAM symbol sequence.

The discrete Fourier terms at the output of the FFT block are then mapped to subcarriers before being converted back into the time domain (IFFT). The final step prior to transmission is appending a CP. It is interesting to note that while the SC-FDMA signal has a lower PAPR in the time domain, individual subcarrier amplitudes can actually vary more in the frequency domain than a comparable OFDM signal.

3.2.2 Multiplexing

Uplink PRBs are assigned to UE by the base station scheduler via the downlink CCPCH. Uplink PRBs consist of a group of 12 contiguous subcarriers for a duration of one slot time.

3.2.3 Uplink Physical Channels

Uplink physical channels are used to transmit information originating in layers above the PHY. Defined UL physical channels are:

Physical Uplink Shared Channel (PUSCH)

Resources for the PUSCH are allocated on a sub-frame basis by the UL scheduler. Subcarriers are allocated in multiples of 12 (PRBs) and may be hopped from sub-frame to sub-frame. The PUSCH may employ QPSK, 16QAM or 64QAM modulation.

Physical Uplink Control Channel (PUCCH)

As the name implies, the PUCCH carries uplink control information. It is never transmitted simultaneously with PUSCH data. PUCCH conveys control information including channel quality indication (CQI), ACK/NACK, HARQ and uplink scheduling requests. The PUCCH transmission is frequency hopped at the slot boundary as shown in Figure 3.2.3-1 for added reliability.

Figure 3.2.3-1 PUCCH is Hopped at Slot Boundary

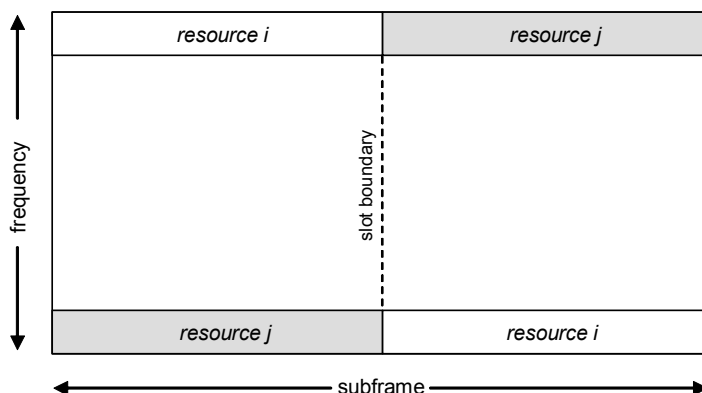

3.2.4 Uplink Physical Signals

Uplink physical signals are used within the PHY and do not convey information from higher layers. Two types of UL physical signals are defined: the reference signal and the random access preamble.

Uplink Reference Signal

There are actually two variants of the UL reference signal. The demodulation signal facilitates coherent demodulation. It is transmitted in the fourth SC-FDMA symbol of the slot and is the same size as the assigned resource. There is also a sounding reference signal used to facilitate frequency dependent scheduling. Both variants of the UL reference signal are based on Zadhoff-Chu sequences.

Random Access Preamble

The random access procedure involves the PHY and higher layers. At the PHY layer, the cell search procedure is initiated by transmission of the random access preamble by the UE. If successful, a random access response is received from the base station. The random access preamble format is shown in Figure 3.2.4-1. It consists of a cyclic prefix, a preamble and a guard time during which there is no signal transmitted.

Figure 3.2.4-1 Random Access Preamble Format

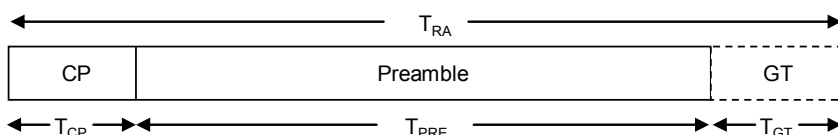

For the generic frame structure, the timing parameters are:

$$T_{RA}: \quad 30720 T_S$$

$$T_{GT}: \quad 3152 T_S$$

$$T_{PRE}: \quad 24576 T_S$$

where T_S = period of a 30.72 MHz clock

Random access preambles are derived from Zadoff-Chu sequences. They are transmitted on blocks of 72 contiguous subcarriers allocated for random access by the base station. In FDD applications, there are 64 possible preamble sequences per cell.

The exact frequency used for transmission of the random access preamble is selected from available random access channels by higher layers in the UE. Other information provided to the PHY by higher layers includes:

- Available random access channels
- Preamble format (which preamble sequences)
- Initial transmission power
- Power ramp step size
- Maximum number of retries

3.2.5 Uplink Transport Channels

As in the DL, uplink transport channels act as service access points for higher layers. Characteristics of UL transport channels are described below.

Uplink – Shared Channel (UL-SCH)

- Support possible use of beam forming
- Support dynamic link adaption (varying modulation, coding and/or Tx power)
- Support for HARQ

- Support for dynamic and semi-static resource allocation

Random Access Channel (RACH)

- Supports transmission of limited control information
- Possible risk of collision

3.2.6 Mapping Uplink Physical Channels to Transport Channels

Transport channels are mapped to physical channels as shown in Figure 3.2.6-1.

3.2.7 Coding

The UL-SCH uses the same rate 1/3 turbo encoding scheme (two 8-state constituent encoders and one internal interleaver) as the DL-SCH.

3.3 MB-SFN

Multimedia Broadcast Multicast Services (MBMS) are performed either in a single cell or multi-cell mode. In single cell transmissions, MBMS traffic is mapped to the DL-SCH. In multi-cell mode, transmissions from cells are carefully synchronized to form a Multicast/Broadcast – Single Frequency Network (MB-SFN).

MB-SFN is an elegant application of OFDM for cellular broadcast. The principle of operation is quite simple. Identical transmissions are broadcast from closely coordinated cells simultaneously on a common frequency. Signals from adjacent cells arrive at the receiver and are dealt with in the same manner as multipath delayed signals. In this manner, UE can combine the energy from multiple transmitters with no additional receiver complexity.

If the UE is at a cell boundary, the relative delay between the two signals is quite small. However, if the UE is close to one base station and relatively distant from a second base station, the amount of delay between the two signals can be quite large. For this reason, MB-SFN transmissions are supported using a 7.5 kHz subcarrier spacing and a longer CP. MB-SFN networks also use a common reference signal from all transmitters within the network to facilitate channel estimation.

As a consequence of the MB-SFN transmission scheme, UE can roam between cells with no handoff procedure required. Signals from various cells will vary in strength and in relative delay, but in aggregate the received signal is still dealt with in the same manner as a conventional single channel OFDM transmission.

4 Conclusions

Although incomplete, the LTE specifications do contain a great deal of useful information. It is entirely possible to construct a reasonably accurate picture of the LTE physical layer at this time. This discussion has hopefully provided the reader with a reasonably complete description of the LTE PHY. In some cases, material has been omitted for the sake of brevity. In other instances, the LTE specifications do not contain much detail at this time. As mentioned above, work on the 3GPP LTE specification is on going at this time and will not be complete before late this year or possibly early 2008.

Figure 3.2.6-1 Mapping of UL Transport Channels to UL Physical Channels

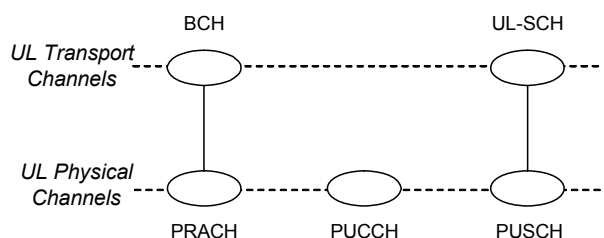

5 References

1. 3GPP TR 25.913 - v7.3.0, *Requirements for EUTRA and EUTRAN*, <http://www.3gpp.org/ftp/Specs/archive/25%5Fseries/25.913/>
2. Van Nee and Prasad, *OFDM for Wireless Multimedia Communications*, Artech House Publishers, ISBN 0-890006-530-6, 2000
3. T Doc #R1-060023, *Cubic Metric in 3GPP-LTE*, Motorola, Helsinki, January 2006
4. 3GPP TS 36.300 – v8.0.0, *E-UTRA and E-UTRAN Overall Description*, <http://www.3gpp.org/ftp/Specs/archive/36%5Fseries/36.300/>
5. 3GPP TS 36.201 – v1.0.0, *LTE Physical Layer – General Description*, <http://www.3gpp.org/ftp/Specs/archive/36%5Fseries/36.201/>
6. 3GPP TS 36.211 – v1.0.0, *Physical Channels and Modulation*, <http://www.3gpp.org/ftp/Specs/archive/36%5Fseries/36.211/>
7. 3GPP TS 36.212 – *Multiplexing and Channel Coding*, <http://www.3gpp.org/ftp/Specs/archive/36%5Fseries/36.212/>
8. 3GPP TS 36.213 – v1.0.0, *Physical Layer Procedures*, <http://www.3gpp.org/ftp/Specs/archive/36%5Fseries/36.213/>
9. 3GPP TS 36.214 – v0.1.0, *Physical Layer – Measurements*, <http://www.3gpp.org/ftp/Specs/archive/36%5Fseries/36.214/>
10. 3GPP TS 36.300 v8.0.0, *E-UTRA and E-UTRAN Overall Description; Stage 2*, <http://www.3gpp.org/ftp/Specs/archive/36%5Fseries/36.300/>

6 Acronyms and Abbreviations

| | | | |
|--------|---|---------|---|
| 16QAM | 16 point quadrature amplitude modulation | MBMS | Multimedia broadcast multicast service |
| 3GPP | Third Generation Partnership Project | MB-SFN | Multicast/broadcast – single frequency network |
| 64QAM | 64 point quadrature amplitude modulation | | |
| ACK | Acknowledgement | MCH | Multicast channel |
| AGC | Automatic gain control | MIMO | Multiple Input Multiple Output |
| AP | Access point | MRC | Maximal ratio combining |
| ARQ | Automatic repeat request | NACK | Not acknowledgement |
| BCH | Broadcast channel | OFDM | Orthogonal Frequency Division Multiplexing |
| BPSK | Binary phase shift keying | | |
| BW | Bandwidth | PAPR | Peak-to-average power ratio |
| CCPCH | Common control physical channel | PCH | Paging channel |
| CDD | Cyclic delay diversity | PDCCH | Physical downlink control channel |
| CDMA | Code Division Multiple Access | PDSCH | Physical downlink shared channel |
| CIR | Channel impulse response | PHY | Physical layer |
| CP | Cyclic prefix | PRACH | Physical random access channel |
| CQI | Channel quality indication | PRB | Physical resource block |
| CSMA | Carrier sense multiple access | PRN | Pseudo random numerical sequence |
| DC | Direct current | PSK | Phase shift keying |
| DFT | Discrete Fourier transform | PUCCH | Physical uplink control channel |
| DL | Downlink | PUSCH | Physical uplink shared channel |
| DL-SCH | Downlink-shared channel | QAM | Quadrature amplitude modulation |
| DRX | Discontinuous receive | QPSK | Quadrature phase shift keying |
| eNodeB | Enhanced Node B (enhanced base station) | RACH | Random access channel |
| | | RFE | Radio front end |
| FDD | Frequency division duplexing | RFPA | Radio frequency power amplifier |
| FFT | Fast Fourier transform | S/P | Serial-to-parallel |
| GMSK | Gaussian minimum shift keying | SAP | Service access point |
| GT | Guard time | SC-FDMA | Single Carrier – Frequency Division Multiple Access |
| HARQ | Hybrid automatic repeat request | | |
| HSDPA | High Speed Downlink Packet Access | SNR | Signal-to-noise ratio |
| HSUPA | High Speed Uplink Packet Access | STA | Station |
| ICI | Inter carrier interface | TDD | Time Division Duplexing |
| IDFT | Inverse discrete Fourier transform | UE | User equipment |
| IEEE | Institute of Electrical and Electronics Engineers | UL | Uplink |
| | | UL-SCH | Uplink – shared channel |
| IFFT | Inverse fast Fourier transform | XCVR | Transceiver |
| ISI | Inter symbol interface | | |
| LO | Local oscillator | | |
| LTE | Long Term Evolution | | |

How to Reach Us:

Home Page:

www.freescale.com

Web Support:

<http://www.freescale.com/support>

USA/Europe or Locations Not Listed:

Freescale Semiconductor, Inc.
Technical Information Center, EL516
2100 East Elliot Road
Tempe, Arizona 85284
+1-800-521-6274 or +1-480-768-2130
www.freescale.com/support

Europe, Middle East and Africa:

Freescale Halbleiter Deutschland GmbH
Technical Information Center
Schatzbogen 7
81829 Muenchen, Germany
+44 1296 380 456 (English)
+46 8 52200080 (English)
+49 89 92103 559 (German)
+33 1 69 35 48 48 (French)
www.freescale.com/support

Japan:

Freescale Semiconductor Japan Ltd.
Headquarters
ARCO Tower 15F
1-8-1, Shimo-Meguro, Meguro-ku,
Tokyo 153-0064, Japan
0120 191014 or +81 3 5437 9125
support.japan@freescale.com

Asia/Pacific:

Freescale Semiconductor Hong Kong Ltd
Technical Information Center
2 Dai King Street
Tai Po Industrial Estate
Tai Po, N.T., Hong Kong
+800 2666 8080
support.asia@freescale.com

For Literature Requests Only:

Freescale Semiconductor
Literature Distribution Center
P.O. Box 5405
Denver, Colorado 80217
1-800-441-2447 or 303-675-2140
Fax: 303-675-2150
LDCForFreescaleSemiconductor@hibbertgroup.com

Information in this document is provided solely to enable system and software implementers to use Freescale Semiconductor products. There are no express or implied copyright license granted hereunder to design or fabricate any integrated circuits or integrated circuits based on the information in this document.

Freescale Semiconductor reserves the right to make changes without further notice to any products herein. Freescale Semiconductor makes no warranty, representation or guarantee regarding the suitability of its products for any particular purpose, nor does Freescale Semiconductor assume any liability arising out of the application or use of any product or circuit, and specifically disclaims any and all liability, including without limitation consequential or incidental damages. "Typical" parameters which may be provided in Freescale Semiconductor data sheets and/or specifications can and do vary in different applications and actual performance may vary over time. All operating parameters, including "Typicals" must be validated for each customer application by customer's technical experts. Freescale Semiconductor does not convey any license under its patent rights nor the rights of others. Freescale Semiconductor products are not designed, intended, or authorized for use as components in systems intended for surgical implant into the body, or other applications intended to support or sustain life, or for any other application in which the failure of the Freescale Semiconductor product could create a situation where personal injury or death may occur. Should Buyer purchase or use Freescale Semiconductor products for any such unintended or unauthorized application, Buyer shall indemnify and hold Freescale Semiconductor and its officers, employees, subsidiaries, affiliates, and distributors harmless against all claims, costs, damages, and expenses, and reasonable attorney fees arising out of, directly or indirectly, any claim of personal injury or death associated with such unintended or unauthorized use, even if such claim alleges that Freescale Semiconductor was negligent regarding the design or manufacture of the part.