

# BLF879P

UHF power LDMOS transistor

Rev. 1 — 23 August 2011

Product data sheet

## 1. Product profile

### 1.1 General description

A 500 W LDMOS RF power transistor for broadcast transmitter applications and industrial applications. The excellent ruggedness of this device makes it ideal for digital and analog transmitter applications.

**Table 1. Application information**

RF performance at  $V_{DS} = 42$  V unless otherwise specified.

Mode of operation	f (MHz)	$P_{L(AV)}$ (W)	$P_{L(M)}$ (W)	$G_p$ (dB)	$\eta_D$ (%)	IMD3 (dBc)	IMD <sub>shldr</sub> (dBc)	PAR (dB)
<b>RF performance in a common source 860 MHz narrowband test circuit</b>								
2-tone, class-AB	$f_1 = 860$ ; $f_2 = 860.1$	200	-	21	47	-33	-	-
DVB-T (8k OFDM)	858	95	-	21	33	-	-31 [1]	8.2 [2]
<b>RF performance in a common source 470 MHz to 860 MHz broadband test circuit</b>								
DVB-T (8k OFDM)	858	95	-	20	32	-	-32 [1]	8.0 [2]

[1] Measured [dBc] with delta marker at 4.3 MHz from center frequency.

[2] PAR (of output signal) at 0.01 % probability on CCDF; PAR of input signal = 9.5 dB at 0.01 % probability on CCDF.

### 1.2 Features and benefits

- Excellent ruggedness
- Optimum thermal behavior and reliability,  $R_{th(j-c)} = 0.15$  K/W
- High power gain
- High efficiency
- Designed for broadband operation (470 MHz to 860 MHz)
- Internal input matching for high gain and optimum broadband operation
- Excellent reliability
- Easy power control
- Compliant to Restriction of Hazardous Substances (RoHS) Directive 2002/95/EC

### 1.3 Applications

- Communication transmitter applications in the UHF band
- Industrial applications in the UHF band



## 2. Pinning information

**Table 2. Pinning**

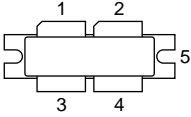
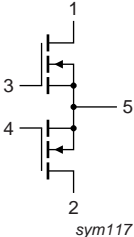
Pin	Description	Simplified outline	Graphic symbol
<b>BLF879P (SOT539A)</b>			
1	drain1		
2	drain2		
3	gate1		
4	gate2		
5	source		

[1] Connected to flange.

## 3. Ordering information

**Table 3. Ordering information**

Type number	Package		
	Name	Description	Version
BLF879P	-	flanged balanced LDMOST ceramic package; 2 mounting holes; 4 leads	SOT539A

## 4. Limiting values

**Table 4. Limiting values**

*In accordance with the Absolute Maximum Rating System (IEC 60134).*

Symbol	Parameter	Conditions	Min	Max	Unit
$V_{DS}$	drain-source voltage		-	104	V
$V_{GS}$	gate-source voltage		-0.5	+11	V
$T_{stg}$	storage temperature		-65	+150	°C
$T_j$	junction temperature		-	200	°C

## 5. Thermal characteristics

**Table 5. Thermal characteristics**

Symbol	Parameter	Conditions	Typ	Unit
$R_{th(j-c)}$	thermal resistance from junction to case	$T_{case} = 80\text{ °C}$ ; $P_{L(AV)} = 95\text{ W}$	[1]	0.15 K/W

[1]  $R_{th(j-c)}$  is measured under RF conditions.

## 6. Characteristics

**Table 6. DC characteristics**

$T_j = 25\text{ °C}$ ; per section unless otherwise specified.

Symbol	Parameter	Conditions	Min	Typ	Max	Unit	
$V_{(BR)DSS}$	drain-source breakdown voltage	$V_{GS} = 0\text{ V}$ ; $I_D = 2.4\text{ mA}$	[1]	104	-	V	
$V_{GS(th)}$	gate-source threshold voltage	$V_{DS} = 10\text{ V}$ ; $I_D = 240\text{ mA}$	[1]	1.4	1.9	2.4	V
$I_{DSS}$	drain leakage current	$V_{GS} = 0\text{ V}$ ; $V_{DS} = 42\text{ V}$	-	-	2.8	$\mu\text{A}$	
$I_{DSX}$	drain cut-off current	$V_{GS} = V_{GS(th)} + 3.75\text{ V}$ ; $V_{DS} = 10\text{ V}$	-	38	-	A	
$I_{GSS}$	gate leakage current	$V_{GS} = 10\text{ V}$ ; $V_{DS} = 0\text{ V}$	-	-	280	nA	
$R_{DS(on)}$	drain-source on-state resistance	$V_{GS} = V_{GS(th)} + 3.75\text{ V}$ ; $I_D = 8.5\text{ A}$	[1]	-	120	$\text{m}\Omega$	
$C_{iss}$	input capacitance	$V_{GS} = 0\text{ V}$ ; $V_{DS} = 42\text{ V}$ ; $f = 1\text{ MHz}$	[2]	-	210	pF	
$C_{oss}$	output capacitance	$V_{GS} = 0\text{ V}$ ; $V_{DS} = 42\text{ V}$ ; $f = 1\text{ MHz}$	-	72	-	pF	
$C_{rss}$	reverse transfer capacitance	$V_{GS} = 0\text{ V}$ ; $V_{DS} = 42\text{ V}$ ; $f = 1\text{ MHz}$	-	1.5	-	pF	

[1]  $I_D$  is the drain current.

[2] Capacitance values without internal matching.

**Table 7. RF characteristics**

RF characteristics in NXP production narrowband test circuit;  $T_{case} = 25\text{ °C}$  unless otherwise specified.

Symbol	Parameter	Conditions	Min	Typ	Max	Unit
<b>2-Tone, class-AB</b>						
$V_{DS}$	drain-source voltage		-	42	-	V
$I_{Dq}$	quiescent drain current		[1]	-	1.3	A
$P_{L(AV)}$	average output power	$f_1 = 860\text{ MHz}$ ; $f_2 = 860.1\text{ MHz}$	200	-	-	W
$G_p$	power gain	$f_1 = 860\text{ MHz}$ ; $f_2 = 860.1\text{ MHz}$	20	21	-	dB
$\eta_D$	drain efficiency	$f_1 = 860\text{ MHz}$ ; $f_2 = 860.1\text{ MHz}$	43	47	-	%
IMD3	third-order intermodulation distortion	$f_1 = 860\text{ MHz}$ ; $f_2 = 860.1\text{ MHz}$	-	-33	-29	dBc

**Table 7. RF characteristics ...continued**

RF characteristics in NXP production narrowband test circuit;  $T_{case} = 25\text{ }^{\circ}\text{C}$  unless otherwise specified.

Symbol	Parameter	Conditions	Min	Typ	Max	Unit	
<b>DVB-T (8k OFDM), class-AB</b>							
$V_{DS}$	drain-source voltage		-	42	-	V	
$I_{Dq}$	quiescent drain current		[1]	-	1.3	A	
$P_{L(AV)}$	average output power	$f = 858\text{ MHz}$	95	-	-	W	
$G_p$	power gain	$f = 858\text{ MHz}$	20	21	-	dB	
$\eta_D$	drain efficiency	$f = 858\text{ MHz}$	30	33	-	%	
$IMD_{shldr}$	intermodulation distortion shoulder	$f = 858\text{ MHz}$	[2]	-	-31	-28	dBc
PAR	peak-to-average ratio	$f = 858\text{ MHz}$	[3]	-	8.2	-	dB

[1]  $I_{dq}$  for total device

[2] Measured [dBc] with delta marker at 4.3 MHz from center frequency.

[3] PAR (of output signal) at 0.01 % probability on CCDF; PAR of input signal = 9.5 dB at 0.01 % probability on CCDF.

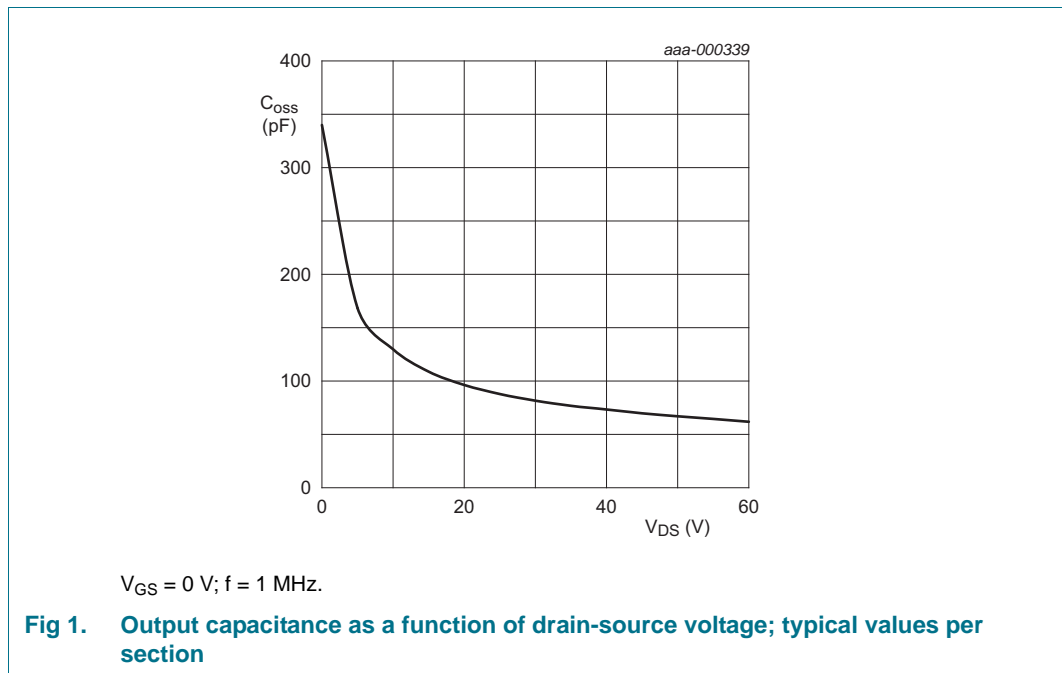

### 6.1 Ruggedness in class-AB operation

The BLF879P is capable of withstanding a load mismatch corresponding to  $VSWR = 40 : 1$  through all phases under the following conditions:  $V_{DS} = 42\text{ V}$ ;  $f = 860\text{ MHz}$  at rated power.

## 7. Application information

### 7.1 Broadband RF figures

#### 7.1.1 DVB-T

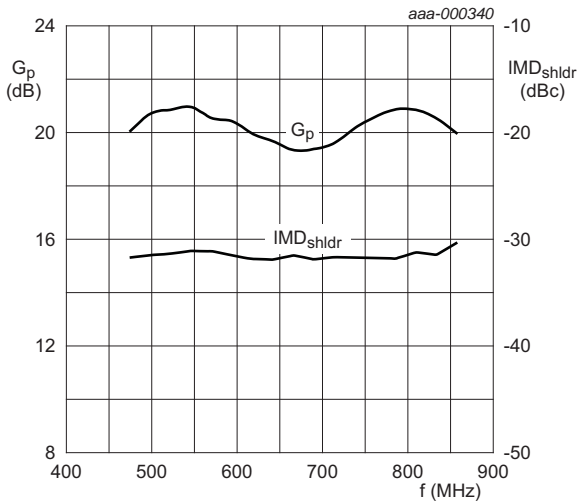

$P_{L(AV)} = 95$  W;  $V_{DS} = 42$  V;  $I_{Dq} = 1.3$  A; measured in a common source broadband test circuit as described in [Section 8](#).

**Fig 2. DVB-T power gain and intermodulation distortion shoulder as function of frequency; typical values**

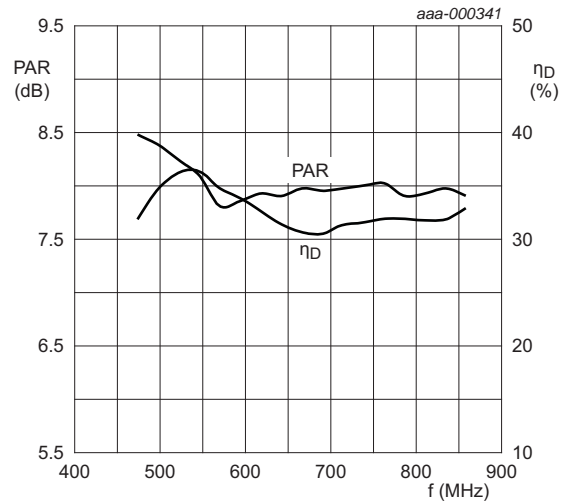

$P_{L(AV)} = 95$  W;  $V_{DS} = 42$  V;  $I_{Dq} = 1.3$  A; measured in a common source broadband test circuit as described in [Section 8](#).

**Fig 3. DVB-T peak-to-average ratio and drain efficiency as function of frequency; typical values**

**7.2 Impedance information**

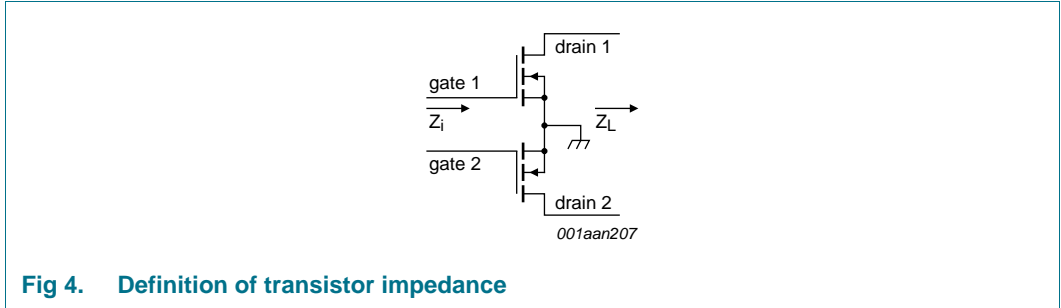

**Fig 4. Definition of transistor impedance**

**Table 8. Typical push-pull impedance**

Simulated  $Z_i$  and  $Z_L$  device impedance; impedance info at  $V_{DS} = 42\text{ V}$  and  $P_{L(AV)} = 95\text{ W}$  (DVB-T).

<b>f</b> <b>MHz</b>	<b><math>Z_i</math></b> <b><math>\Omega</math></b>	<b><math>Z_L</math></b> <b><math>\Omega</math></b>
300	0.617 – j1.715	4.164 + j0.608
325	0.635 – j1.355	4.101 + j0.636
350	0.655 – j1.026	4.036 + j0.661
375	0.677 – j0.721	3.968 + j0.681
400	0.702 – j0.435	3.898 + j0.696
425	0.731 – j0.164	3.826 + j0.707
450	0.762 + j0.096	3.753 + j0.713
475	0.798 + j0.347	3.679 + j0.715
500	0.839 + j0.592	3.604 + j0.713
525	0.884 + j0.833	3.528 + j0.706
550	0.936 + j1.072	3.453 + j0.695
575	0.995 + j1.310	3.377 + j0.680
600	1.063 + j1.549	3.302 + j0.661
625	1.141 + j1.791	3.227 + j0.638
650	1.230 + j2.037	3.153 + j0.612
675	1.334 + j2.289	3.079+ j0.582
700	1.456 + j2.548	3.007 + j0.549
725	1.599 + j2.814	2.936 + j0.513
750	1.768 + j3.090	2.866 + j0.474
775	1.971 + j3.376	2.797 + j0.432
800	2.214 + j3.671	2.729 + j0.387
825	2.510 + j3.975	2.663 + j0.340
850	2.873 + j4.282	2.599 + j0.291
875	3.320 + j4.584	2.535 + j0.240
900	3.875 + j4.865	2.474+ j0.186
925	4.562 + j5.095	2.414 + j0.131
950	5.409 + j5.223	2.355 + j0.074
975	6.426 + j5.166	2.298 + j0.015
1000	7.587 + j4.807	2.243 – j0.045

**7.3 Reliability**

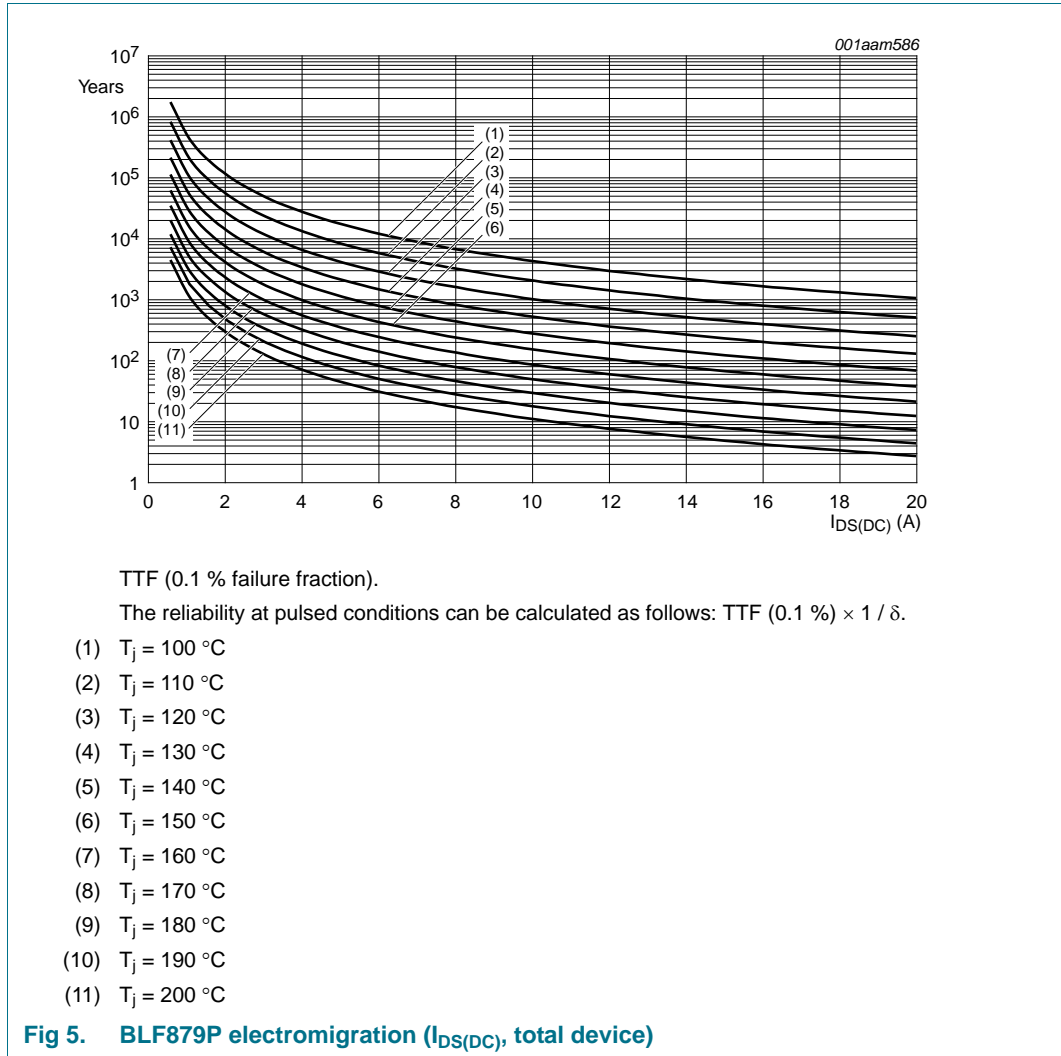

## 8. Test information

**Table 9. List of components**

For test circuit, see [Figure 6](#), [Figure 7](#) and [Figure 8](#).

Component	Description	Value	Remarks
B1, B2	semi rigid coax	25 $\Omega$ ; 49.5 mm	UT-090C-25 (EZ 90-25)
C1	multilayer ceramic chip capacitor	12 pF	[1]
C2, C3, C4, C5, C6	multilayer ceramic chip capacitor	8.2 pF	[1]
C7	multilayer ceramic chip capacitor	6.8 pF	[2]
C8	multilayer ceramic chip capacitor	2.7 pF	[2]
C9	multilayer ceramic chip capacitor	2.2 pF	[2]
C10, C13, C14	multilayer ceramic chip capacitor	100 pF	[3]
C11, C12	multilayer ceramic chip capacitor	10 pF	[2]
C15, C16	multilayer ceramic chip capacitor	4.7 $\mu$ F, 50 V	Kemet C1210X475K5RAC-TU or capacitor of same quality.
C17, C18, C23, C24	multilayer ceramic chip capacitor	100 pF	[2]
C19, C20	multilayer ceramic chip capacitor	10 $\mu$ F, 50 V	TDK C570X7R1H106KT000N or capacitor of same quality.
C21, C22	electrolytic capacitor	470 $\mu$ F; 63 V	
C30	multilayer ceramic chip capacitor	10 pF	[4]
C31	multilayer ceramic chip capacitor	9.1 pF	[4]
C32	multilayer ceramic chip capacitor	3.9 pF	[4]
C33, C34, C35	multilayer ceramic chip capacitor	100 pF	[4]
C36, C37	multilayer ceramic chip capacitor	4.7 $\mu$ F, 50 V	TDK C4532X7R1E475MT020U or capacitor of same quality.
L1	microstrip	-	[5] (W $\times$ L) 15 mm $\times$ 13 mm
L2	microstrip	-	[5] (W $\times$ L) 5 mm $\times$ 26 mm
L3, L32	microstrip	-	[5] (W $\times$ L) 2 mm $\times$ 49.5 mm
L4	microstrip	-	[5] (W $\times$ L) 1.7 mm 3.5 mm
L5	microstrip	-	[5] (W $\times$ L) 2 mm $\times$ 9.5 mm
L30	microstrip	-	[5] (W $\times$ L) 5 mm $\times$ 13 mm
L31	microstrip	-	[5] (W $\times$ L) 2 mm $\times$ 11 mm
L33	microstrip	-	[5] (W $\times$ L) 2 mm $\times$ 3 mm
R1, R2	wire resistor	10 $\Omega$	
R3, R4	SMD resistor	5.6 $\Omega$	0805
R5, R6	wire resistor	100 $\Omega$	
R7, R8	potentiometer	10 k $\Omega$	

[1] American technical ceramics type 800R or capacitor of same quality.

[2] American technical ceramics type 800B or capacitor of same quality.

[3] American technical ceramics type 180R or capacitor of same quality.

[4] American technical ceramics type 100A or capacitor of same quality.

[5] Printed-Circuit Board (PCB): Taconic RF35;  $\epsilon_r = 3.5$  F/m; height = 0.762 mm; Cu (top/bottom metallization); thickness copper plating = 35  $\mu$ m.

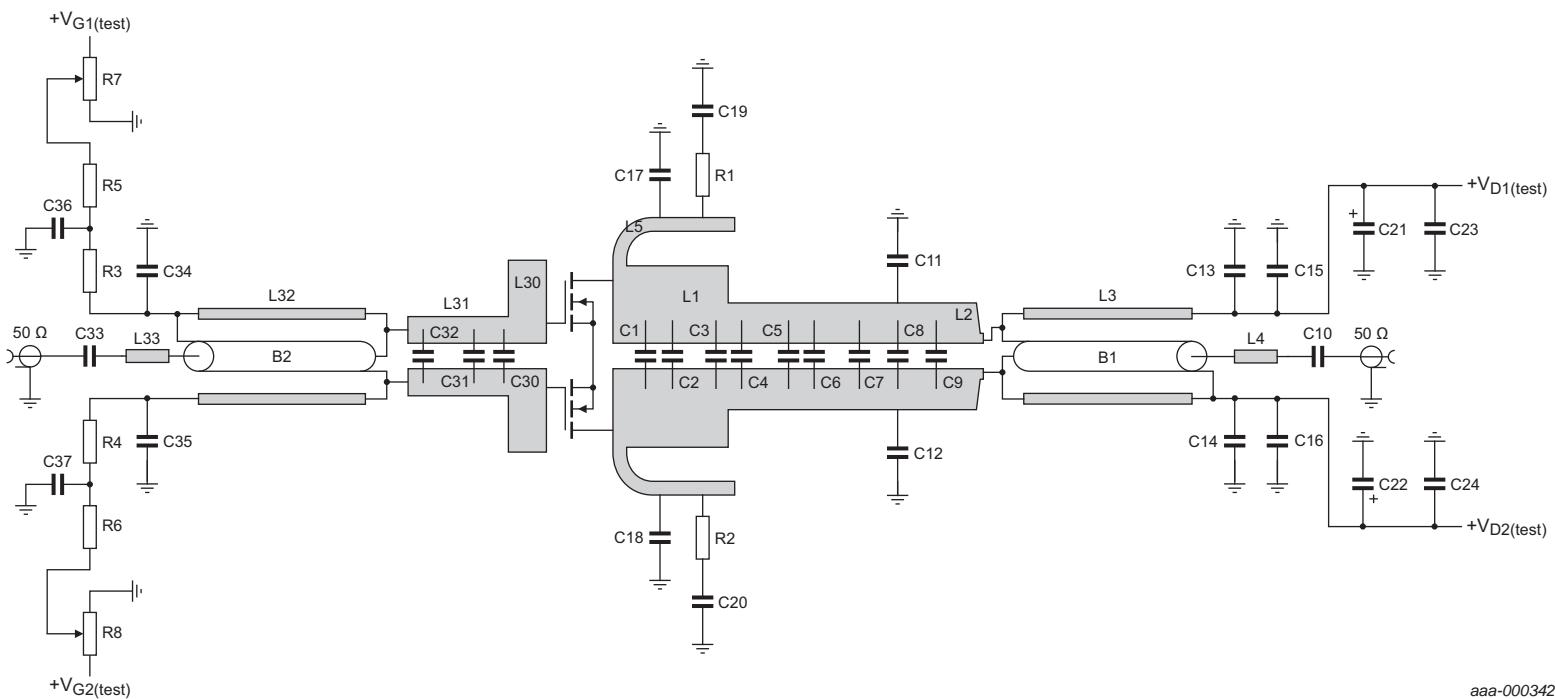

aaa-000342

See [Table 9](#) for a list of components.

**Fig 6. Class-AB common source broadband amplifier;  $V_{D1(test)}$ ,  $V_{D2(test)}$ ,  $V_{G1(test)}$  and  $V_{G2(test)}$  are drain and gate test voltages**

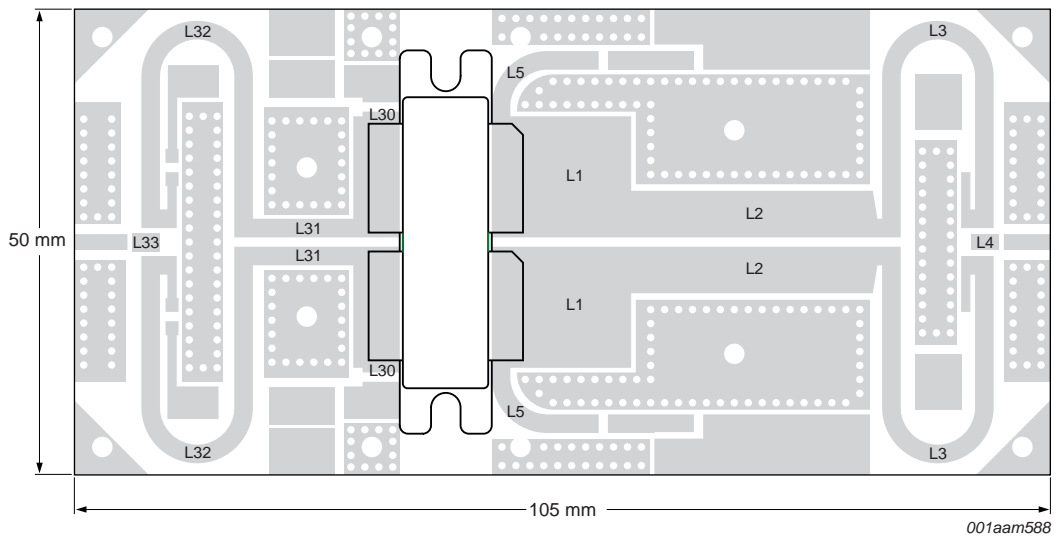

See [Table 9](#) for a list of components.

**Fig 7. Printed-Circuit Board (PCB) for class-AB common source amplifier**

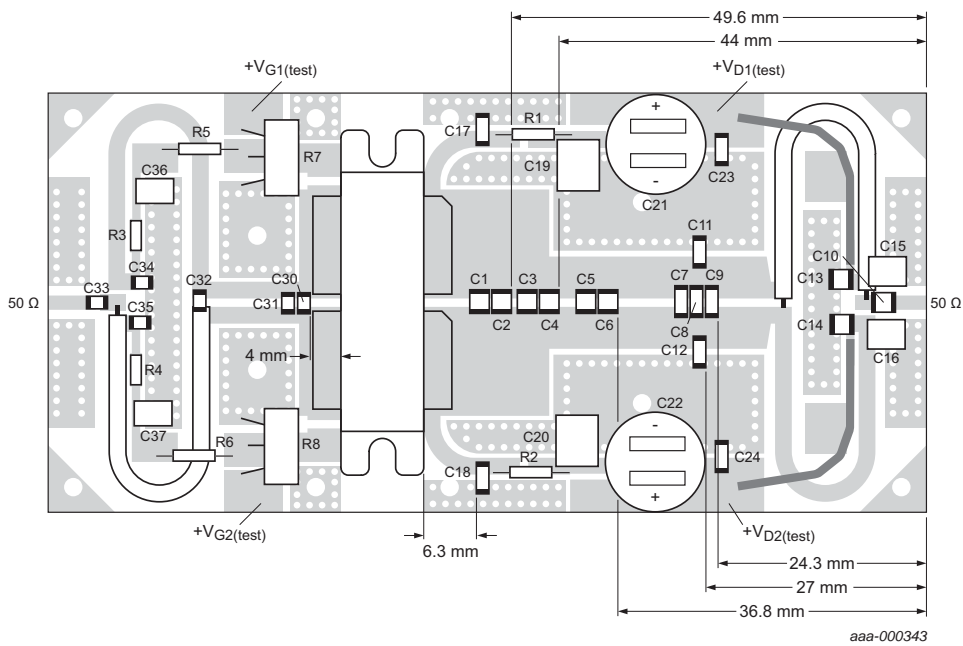

See [Table 9](#) for a list of components.

**Fig 8. Component layout for class-AB common source amplifier**

9. Package outline

Flanged balanced LDMOST ceramic package; 2 mounting holes; 4 leads

SOT539A

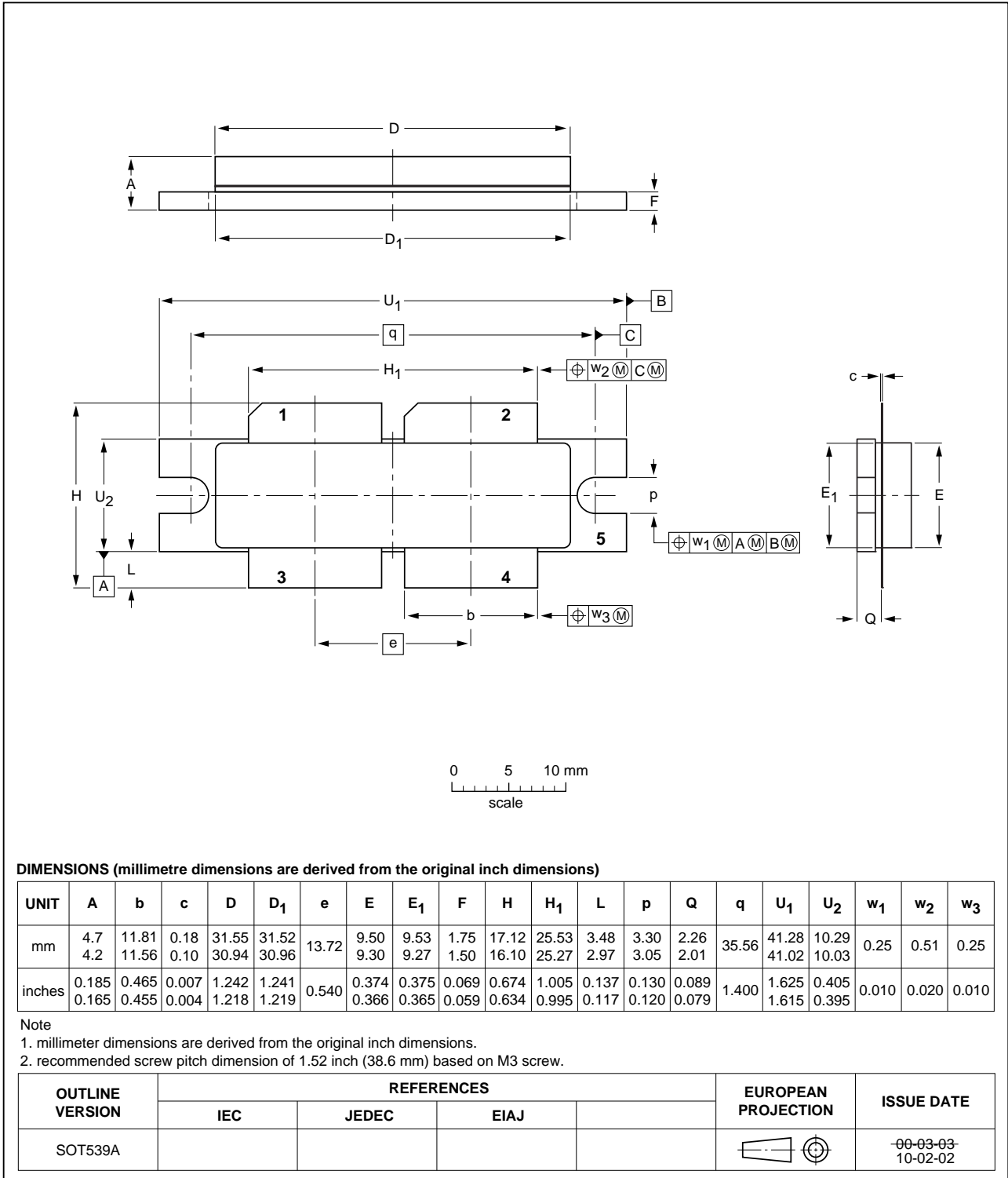

Fig 9. Package outline SOT539A

## 10. Handling information

### CAUTION



This device is sensitive to ElectroStatic Discharge (ESD). Observe precautions for handling electrostatic sensitive devices.

Such precautions are described in the *ANSI/ESD S20.20*, *IEC/ST 61340-5*, *JESD625-A* or equivalent standards.

## 11. Abbreviations

Table 10. Abbreviations

Acronym	Description
CCDF	Complementary Cumulative Distribution Function
DVB-T	Digital Video Broadcast - Terrestrial
LDMOS	Laterally Diffused Metal-Oxide Semiconductor
LDMOST	Laterally Diffused Metal-Oxide Semiconductor Transistor
OFDM	Orthogonal Frequency Division Multiplexing
PAR	Peak-to-Average power Ratio
RF	Radio Frequency
SMD	Surface Mounted Device
UHF	Ultra High Frequency
VSWR	Voltage Standing-Wave Ratio

## 12. Revision history

Table 11. Revision history

Document ID	Release date	Data sheet status	Change notice	Supersedes
BLF879P v.1	20110823	Product data sheet	-	-

## 13. Legal information

### 13.1 Data sheet status

Document status <sup>[1][2]</sup>	Product status <sup>[3]</sup>	Definition
Objective [short] data sheet	Development	This document contains data from the objective specification for product development.
Preliminary [short] data sheet	Qualification	This document contains data from the preliminary specification.
Product [short] data sheet	Production	This document contains the product specification.

[1] Please consult the most recently issued document before initiating or completing a design.

[2] The term 'short data sheet' is explained in section "Definitions".

[3] The product status of device(s) described in this document may have changed since this document was published and may differ in case of multiple devices. The latest product status information is available on the Internet at URL <http://www.nxp.com>.

### 13.2 Definitions

**Draft** — The document is a draft version only. The content is still under internal review and subject to formal approval, which may result in modifications or additions. NXP Semiconductors does not give any representations or warranties as to the accuracy or completeness of information included herein and shall have no liability for the consequences of use of such information.

**Short data sheet** — A short data sheet is an extract from a full data sheet with the same product type number(s) and title. A short data sheet is intended for quick reference only and should not be relied upon to contain detailed and full information. For detailed and full information see the relevant full data sheet, which is available on request via the local NXP Semiconductors sales office. In case of any inconsistency or conflict with the short data sheet, the full data sheet shall prevail.

**Product specification** — The information and data provided in a Product data sheet shall define the specification of the product as agreed between NXP Semiconductors and its customer, unless NXP Semiconductors and customer have explicitly agreed otherwise in writing. In no event however, shall an agreement be valid in which the NXP Semiconductors product is deemed to offer functions and qualities beyond those described in the Product data sheet.

### 13.3 Disclaimers

**Limited warranty and liability** — Information in this document is believed to be accurate and reliable. However, NXP Semiconductors does not give any representations or warranties, expressed or implied, as to the accuracy or completeness of such information and shall have no liability for the consequences of use of such information.

In no event shall NXP Semiconductors be liable for any indirect, incidental, punitive, special or consequential damages (including - without limitation - lost profits, lost savings, business interruption, costs related to the removal or replacement of any products or rework charges) whether or not such damages are based on tort (including negligence), warranty, breach of contract or any other legal theory.

Notwithstanding any damages that customer might incur for any reason whatsoever, NXP Semiconductors' aggregate and cumulative liability towards customer for the products described herein shall be limited in accordance with the *Terms and conditions of commercial sale* of NXP Semiconductors.

**Right to make changes** — NXP Semiconductors reserves the right to make changes to information published in this document, including without limitation specifications and product descriptions, at any time and without notice. This document supersedes and replaces all information supplied prior to the publication hereof.

**Suitability for use** — NXP Semiconductors products are not designed, authorized or warranted to be suitable for use in life support, life-critical or safety-critical systems or equipment, nor in applications where failure or

malfunction of an NXP Semiconductors product can reasonably be expected to result in personal injury, death or severe property or environmental damage. NXP Semiconductors accepts no liability for inclusion and/or use of NXP Semiconductors products in such equipment or applications and therefore such inclusion and/or use is at the customer's own risk.

**Applications** — Applications that are described herein for any of these products are for illustrative purposes only. NXP Semiconductors makes no representation or warranty that such applications will be suitable for the specified use without further testing or modification.

Customers are responsible for the design and operation of their applications and products using NXP Semiconductors products, and NXP Semiconductors accepts no liability for any assistance with applications or customer product design. It is customer's sole responsibility to determine whether the NXP Semiconductors product is suitable and fit for the customer's applications and products planned, as well as for the planned application and use of customer's third party customer(s). Customers should provide appropriate design and operating safeguards to minimize the risks associated with their applications and products.

NXP Semiconductors does not accept any liability related to any default, damage, costs or problem which is based on any weakness or default in the customer's applications or products, or the application or use by customer's third party customer(s). Customer is responsible for doing all necessary testing for the customer's applications and products using NXP Semiconductors products in order to avoid a default of the applications and the products or of the application or use by customer's third party customer(s). NXP does not accept any liability in this respect.

**Limiting values** — Stress above one or more limiting values (as defined in the Absolute Maximum Ratings System of IEC 60134) will cause permanent damage to the device. Limiting values are stress ratings only and (proper) operation of the device at these or any other conditions above those given in the Recommended operating conditions section (if present) or the Characteristics sections of this document is not warranted. Constant or repeated exposure to limiting values will permanently and irreversibly affect the quality and reliability of the device.

**Terms and conditions of commercial sale** — NXP Semiconductors products are sold subject to the general terms and conditions of commercial sale, as published at <http://www.nxp.com/profile/terms>, unless otherwise agreed in a valid written individual agreement. In case an individual agreement is concluded only the terms and conditions of the respective agreement shall apply. NXP Semiconductors hereby expressly objects to applying the customer's general terms and conditions with regard to the purchase of NXP Semiconductors products by customer.

**No offer to sell or license** — Nothing in this document may be interpreted or construed as an offer to sell products that is open for acceptance or the grant, conveyance or implication of any license under any copyrights, patents or other industrial or intellectual property rights.

**Export control** — This document as well as the item(s) described herein may be subject to export control regulations. Export might require a prior authorization from national authorities.

**Non-automotive qualified products** — Unless this data sheet expressly states that this specific NXP Semiconductors product is automotive qualified, the product is not suitable for automotive use. It is neither qualified nor tested in accordance with automotive testing or application requirements. NXP Semiconductors accepts no liability for inclusion and/or use of non-automotive qualified products in automotive equipment or applications.

In the event that customer uses the product for design-in and use in automotive applications to automotive specifications and standards, customer (a) shall use the product without NXP Semiconductors' warranty of the product for such automotive applications, use and specifications, and (b) whenever customer uses the product for automotive applications beyond NXP Semiconductors' specifications such use shall be solely at customer's own risk, and (c) customer fully indemnifies NXP Semiconductors for any liability, damages or failed product claims resulting from customer design and use of the product for automotive applications beyond NXP Semiconductors' standard warranty and NXP Semiconductors' product specifications.

## 14. Contact information

For more information, please visit: <http://www.nxp.com>

For sales office addresses, please send an email to: [salesaddresses@nxp.com](mailto:salesaddresses@nxp.com)

## 13.4 Licenses

### ICs with DVB-T or DVB-T2 functionality

Use of this product in any manner that complies with the DVB-T or the DVB-T2 standard may require licenses under applicable patents of the DVB-T respectively the DVB-T2 patent portfolio, which license is available from Sisvel S.p.A., Via Sestriere 100, 10060 None (TO), Italy, and under applicable patents of other parties.

## 13.5 Trademarks

Notice: All referenced brands, product names, service names and trademarks are the property of their respective owners.

## 15. Contents

<b>1</b>	<b>Product profile</b> . . . . .	<b>1</b>
1.1	General description . . . . .	1
1.2	Features and benefits . . . . .	1
1.3	Applications . . . . .	1
<b>2</b>	<b>Pinning information</b> . . . . .	<b>2</b>
<b>3</b>	<b>Ordering information</b> . . . . .	<b>2</b>
<b>4</b>	<b>Limiting values</b> . . . . .	<b>2</b>
<b>5</b>	<b>Thermal characteristics</b> . . . . .	<b>2</b>
<b>6</b>	<b>Characteristics</b> . . . . .	<b>3</b>
6.1	Ruggedness in class-AB operation . . . . .	4
<b>7</b>	<b>Application information</b> . . . . .	<b>5</b>
7.1	Broadband RF figures . . . . .	5
7.1.1	DVB-T . . . . .	5
7.2	Impedance information . . . . .	6
7.3	Reliability . . . . .	7
<b>8</b>	<b>Test information</b> . . . . .	<b>8</b>
<b>9</b>	<b>Package outline</b> . . . . .	<b>11</b>
<b>10</b>	<b>Handling information</b> . . . . .	<b>12</b>
<b>11</b>	<b>Abbreviations</b> . . . . .	<b>12</b>
<b>12</b>	<b>Revision history</b> . . . . .	<b>12</b>
<b>13</b>	<b>Legal information</b> . . . . .	<b>13</b>
13.1	Data sheet status . . . . .	13
13.2	Definitions . . . . .	13
13.3	Disclaimers . . . . .	13
13.4	Licenses . . . . .	14
13.5	Trademarks . . . . .	14
<b>14</b>	<b>Contact information</b> . . . . .	<b>14</b>
<b>15</b>	<b>Contents</b> . . . . .	<b>15</b>

Please be aware that important notices concerning this document and the product(s) described herein, have been included in section 'Legal information'.

© NXP B.V. 2011.

All rights reserved.

For more information, please visit: <http://www.nxp.com>

For sales office addresses, please send an email to: [salesaddresses@nxp.com](mailto:salesaddresses@nxp.com)

Date of release: 23 August 2011

Document identifier: BLF879P