

BUK7108-40AIE

N-channel TrenchPLUS standard level FET

Rev. 03 — 19 February 2009

Product data sheet

1. Product profile

1.1 General description

Standard level N-channel enhancement mode Field-Effect Transistor (FET) in a plastic package using TrenchMOS technology. The devices include TrenchPLUS current sensing and diodes for ElectroStatic Discharge (ESD) protection. This product has been designed and qualified to the appropriate AEC standard for use in automotive critical applications.

1.2 Features and benefits

- Electrostatically robust due to integrated protection diodes
- Low conduction losses due to low on-state resistance
- Q101 compliant
- Reduced component count due to integrated current sensor
- Suitable for standard level gate drive sources

1.3 Applications

- Electrical Power Assisted Steering (EPAS)
- Variable Valve Timing for engines

1.4 Quick reference data

Table 1. Quick reference

Symbol	Parameter	Conditions	Min	Typ	Max	Unit
V_{DS}	drain-source voltage	$T_j \geq 25\text{ °C}; T_j \leq 175\text{ °C}$	-	-	40	V
I_D	drain current	$V_{GS} = 10\text{ V}; T_{mb} = 25\text{ °C};$ see Figure 2 ; see Figure 3 ;	[1]	-	117	A
Static characteristics						
$R_{DS(on)}$	drain-source on-state resistance	$V_{GS} = 10\text{ V}; I_D = 50\text{ A};$ $T_j = 25\text{ °C};$ see Figure 7 ; see Figure 8	-	6	8	m Ω
I_D/I_{sense}	ratio of drain current to sense current	$T_j > -55\text{ °C}; T_j < 175\text{ °C};$ $V_{GS} > 10\text{ V}$	450	500	550	

[1] Current is limited by power dissipation chip rating.

2. Pinning information

Table 2. Pinning information

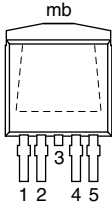
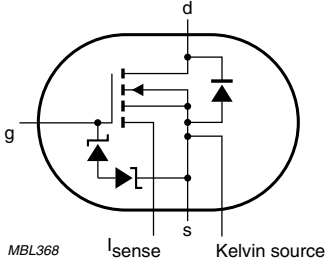
Pin	Symbol	Description	Simplified outline	Graphic symbol
1	G	gate	 <p>SOT426 (D2PAK)</p>	 <p><i>MBL368</i> I_{sense} Kelvin source</p>
2	ISENSE	sense current		
3	D	drain		
4	KS	Kelvin source		
5	S	source		
mb	D	mounting base; connected to drain		

3. Ordering information

Table 3. Ordering information

Type number	Package		Version
	Name	Description	
BUK7108-40AIE	D2PAK	plastic single-ended surface-mounted package (D2PAK); 5 leads (one lead cropped)	SOT426

4. Limiting values

Table 4. Limiting values

In accordance with the Absolute Maximum Rating System (IEC 60134).

Symbol	Parameter	Conditions	Min	Max	Unit	
V_{DS}	drain-source voltage	$T_j \geq 25\text{ °C}$; $T_j \leq 175\text{ °C}$	-	40	V	
V_{DGR}	drain-gate voltage	$R_{GS} = 20\text{ k}\Omega$	-	40	V	
V_{GS}	gate-source voltage		-20	20	V	
I_D	drain current	$T_{mb} = 25\text{ °C}$; $V_{GS} = 10\text{ V}$; see Figure 2 ; see Figure 3 ;	[1]	-	117	A
			[2]	-	75	A
		$T_{mb} = 100\text{ °C}$; $V_{GS} = 10\text{ V}$; see Figure 2 ;	[2]	-	75	A
I_{DM}	peak drain current	$T_{mb} = 25\text{ °C}$; $t_p \leq 10\text{ }\mu\text{s}$; pulsed; see Figure 3	-	468	A	
P_{tot}	total power dissipation	$T_{mb} = 25\text{ °C}$; see Figure 1	-	221	W	
$I_{GS(CL)}$	gate-source clamping current	continuous	-	10	mA	
		pulsed; $t_p = 5\text{ ms}$; $\delta = 0.01$	-	50	mA	
T_{stg}	storage temperature		-55	175	°C	
T_j	junction temperature		-55	175	°C	
Source-drain diode						
I_S	source current	$T_{mb} = 25\text{ °C}$;	[1]	-	117	A
			[2]	-	75	A
I_{SM}	peak source current	$t_p \leq 10\text{ }\mu\text{s}$; pulsed; $T_{mb} = 25\text{ °C}$	-	468	A	
Avalanche ruggedness						
$E_{DS(AL)S}$	non-repetitive drain-source avalanche energy	$I_D = 75\text{ A}$; $V_{sup} \leq 40\text{ V}$; $R_{GS} = 50\text{ }\Omega$; $V_{GS} = 10\text{ V}$; $T_{j(init)} = 25\text{ °C}$; unclamped	-	0.63	J	
Electrostatic discharge						
V_{esd}	electrostatic discharge voltage	HBM; $C = 100\text{ pF}$; $R = 1.5\text{ k}\Omega$	-	6	kV	

[1] Current is limited by power dissipation chip rating.

[2] Continuous current is limited by package.

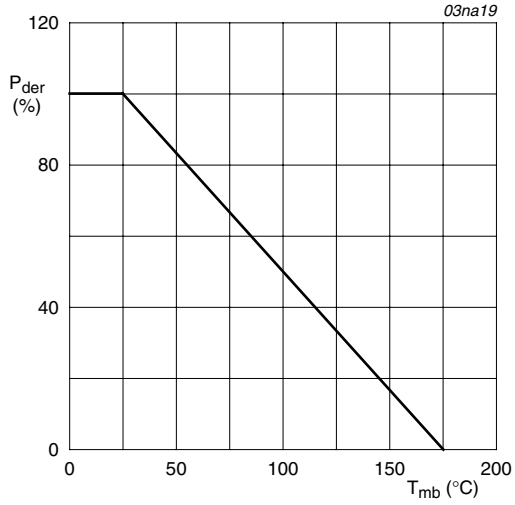

$$P_{der} = \frac{P_{tot}}{P_{tot(25^{\circ}C)}} \times 100\%$$

Fig 1. Normalized total power dissipation as a function of mounting base temperature

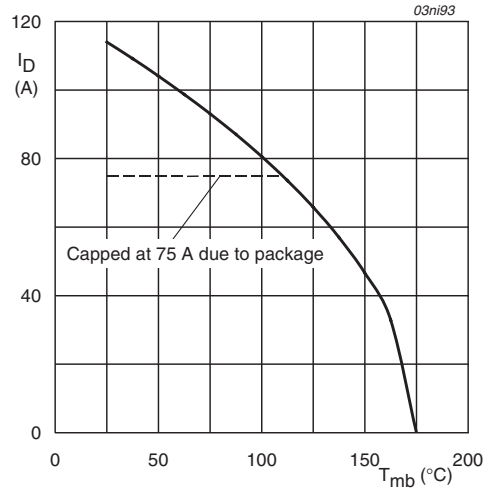

$$V_{GS} \geq 10V$$

Fig 2. Normalized continuous drain current as a function of mounting base temperature

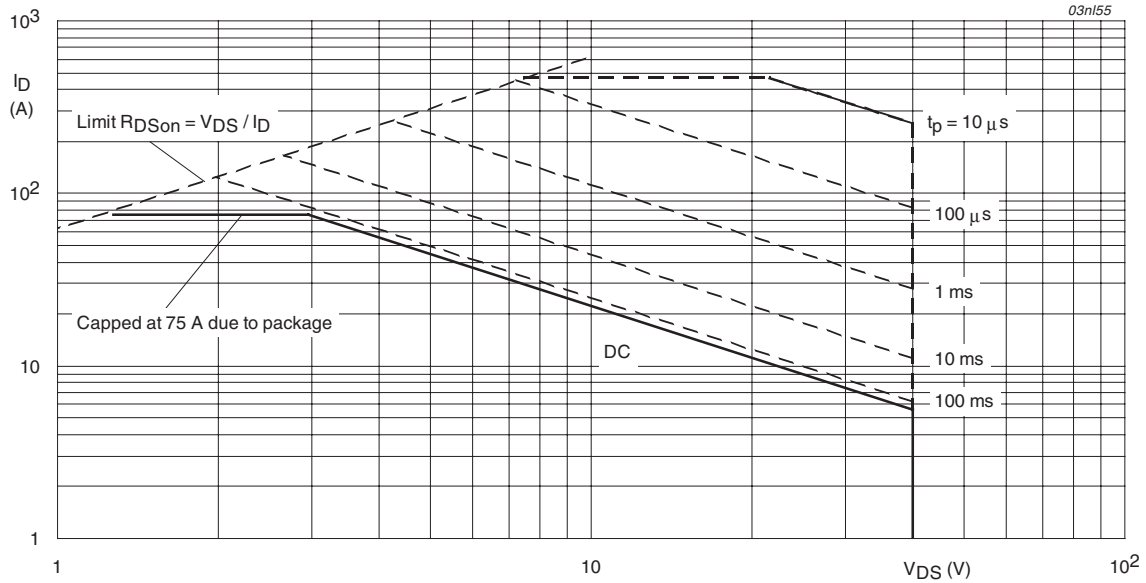

$$T_{mb} = 25^{\circ}C; I_{DM} \text{ is single pulse}$$

Fig 3. Safe operating area; continuous and peak drain currents as a function of drain-source voltage

5. Thermal characteristics

Table 5. Thermal characteristics

Symbol	Parameter	Conditions	Min	Typ	Max	Unit
$R_{th(j-a)}$	thermal resistance from junction to ambient	minimum footprint; mounted on a printed-circuit board	-	50	-	K/W
$R_{th(j-mb)}$	thermal resistance from junction to mounting base	see Figure 4	-	-	0.68	K/W

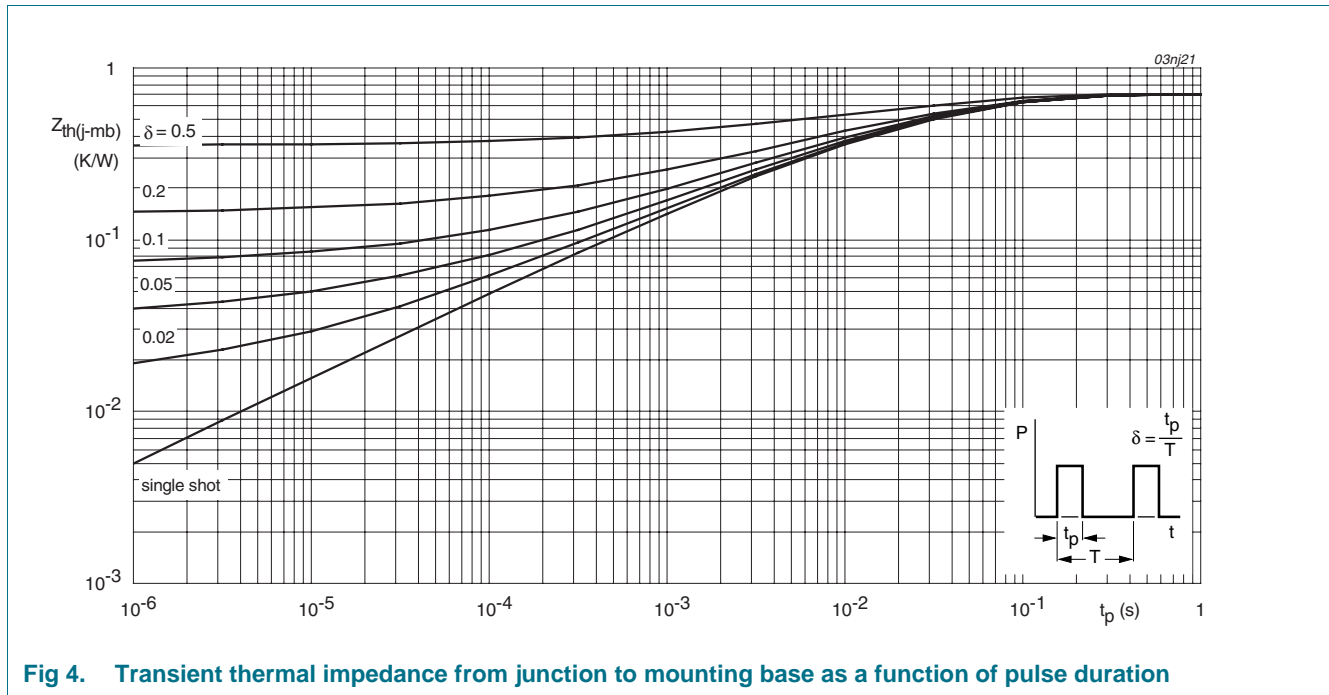

Fig 4. Transient thermal impedance from junction to mounting base as a function of pulse duration

6. Characteristics

Table 6. Characteristics

Symbol	Parameter	Conditions	Min	Typ	Max	Unit
Static characteristics						
$V_{(BR)DSS}$	drain-source breakdown voltage	$I_D = 0.25 \text{ mA}; V_{GS} = 0 \text{ V}; T_j = 25 \text{ }^\circ\text{C}$	40	-	-	V
		$I_D = 0.25 \text{ mA}; V_{GS} = 0 \text{ V}; T_j = -55 \text{ }^\circ\text{C}$	36	-	-	V
$V_{GS(th)}$	gate-source threshold voltage	$I_D = 1 \text{ mA}; V_{DS} = V_{GS}; T_j = 25 \text{ }^\circ\text{C};$ see Figure 9	2	3	4	V
		$I_D = 1 \text{ mA}; V_{DS} = V_{GS}; T_j = 175 \text{ }^\circ\text{C};$ see Figure 9	1	-	-	V
		$I_D = 1 \text{ mA}; V_{DS} = V_{GS}; T_j = -55 \text{ }^\circ\text{C};$ see Figure 9	-	-	4.4	V
I_{DSS}	drain leakage current	$V_{DS} = 40 \text{ V}; V_{GS} = 0 \text{ V}; T_j = 25 \text{ }^\circ\text{C}$	-	0.1	10	μA
		$V_{DS} = 40 \text{ V}; V_{GS} = 0 \text{ V}; T_j = 175 \text{ }^\circ\text{C}$	-	-	250	μA
$V_{(BR)GSS}$	gate-source breakdown voltage	$I_G = 1 \text{ mA}; V_{DS} = 0 \text{ V}; T_j > -55 \text{ }^\circ\text{C};$ $T_j < 175 \text{ }^\circ\text{C}$	20	22	-	V
		$I_G = -1 \text{ mA}; V_{DS} = 0 \text{ V}; T_j > -55 \text{ }^\circ\text{C};$ $T_j < 175 \text{ }^\circ\text{C}$	20	22	-	V
I_{GSS}	gate leakage current	$V_{DS} = 0 \text{ V}; V_{GS} = 10 \text{ V}; T_j = 25 \text{ }^\circ\text{C}$	-	22	300	nA
		$V_{DS} = 0 \text{ V}; V_{GS} = -10 \text{ V}; T_j = 25 \text{ }^\circ\text{C}$	-	22	300	nA
		$V_{DS} = 0 \text{ V}; V_{GS} = 10 \text{ V}; T_j = 175 \text{ }^\circ\text{C}$	-	-	10	μA
		$V_{DS} = 0 \text{ V}; V_{GS} = -10 \text{ V}; T_j = 175 \text{ }^\circ\text{C}$	-	-	10	μA
$R_{DS(on)}$	drain-source on-state resistance	$V_{GS} = 10 \text{ V}; I_D = 50 \text{ A}; T_j = 25 \text{ }^\circ\text{C};$ see Figure 7 ; see Figure 8	-	6	8	m Ω
		$V_{GS} = 10 \text{ V}; I_D = 50 \text{ A}; T_j = 175 \text{ }^\circ\text{C};$ see Figure 7 ; see Figure 8	-	-	15.2	m Ω
$R_{(D-ISENSE)on}$	drain-ISENSE on-state resistance	$V_{GS} = 10 \text{ V}; I_D = 10 \text{ mA}; T_j = 25 \text{ }^\circ\text{C}$	1.59	1.87	2.2	Ω
		$V_{GS} = 10 \text{ V}; I_D = 10 \text{ mA}; T_j = 175 \text{ }^\circ\text{C}$	3.02	3.55	4.18	Ω
I_D/I_{sense}	ratio of drain current to sense current	$V_{GS} > 10 \text{ V}; T_j > -55 \text{ }^\circ\text{C}; T_j < 175 \text{ }^\circ\text{C}$	450	500	550	
Dynamic characteristics						
$Q_{G(tot)}$	total gate charge	$I_D = 25 \text{ A}; V_{DS} = 32 \text{ V}; V_{GS} = 10 \text{ V};$ $T_j = 25 \text{ }^\circ\text{C};$ see Figure 14	-	78	84	nC
Q_{GS}	gate-source charge		-	14	16	nC
Q_{GD}	gate-drain charge		-	34	36	nC
C_{iss}	input capacitance	$V_{GS} = 0 \text{ V}; V_{DS} = 25 \text{ V}; f = 1 \text{ MHz};$ $T_j = 25 \text{ }^\circ\text{C};$ see Figure 12	-	2670	3140	pF
C_{oss}	output capacitance		-	900	1053	pF
C_{rss}	reverse transfer capacitance		-	560	653	pF
$t_{d(on)}$	turn-on delay time	$V_{DS} = 30 \text{ V}; R_L = 1.2 \text{ } \Omega; V_{GS} = 10 \text{ V};$ $R_{G(ext)} 10 \text{ } \Omega; T_j = 25 \text{ }^\circ\text{C}$	-	19	-	ns
t_r	rise time		-	76	-	ns
$t_{d(off)}$	turn-off delay time		-	121	-	ns
t_f	fall time		-	122	-	ns

Table 6. Characteristics ...continued

Symbol	Parameter	Conditions	Min	Typ	Max	Unit
L_D	internal drain inductance	from upper edge of drain mounting base to centre of die; $T_j = 25\text{ °C}$	-	2.5	-	nH
L_S	internal source inductance	from source lead to source bond pad; $T_j = 25\text{ °C}$; lead length 6 mm	-	7.5	-	nH
Source-drain diode						
V_{SD}	source-drain voltage	$I_S = 40\text{ A}$; $V_{GS} = 0\text{ V}$; $T_j = 25\text{ °C}$; see Figure 17	-	0.85	1.2	V
t_{rr}	reverse recovery time	$I_S = 20\text{ A}$; $di_S/dt = -100\text{ A}/\mu\text{s}$; $V_{GS} = -10\text{ V}$;	-	55	-	ns
Q_r	recovered charge	$V_{DS} = 30\text{ V}$; $T_j = 25\text{ °C}$	-	30	-	nC

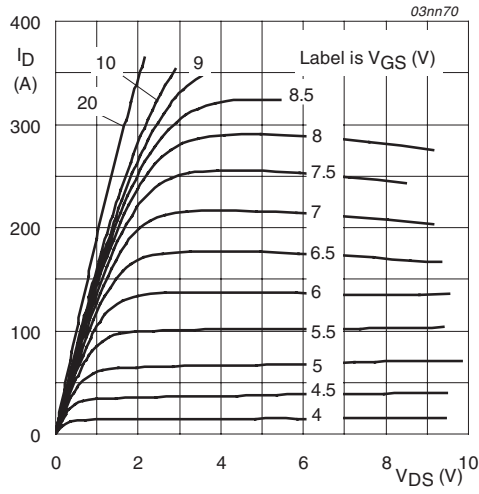

$T_j = 25^\circ\text{C}; t_p = 300\mu\text{s}$

Fig 5. Output characteristics: drain current as a function of drain-source voltage; typical values

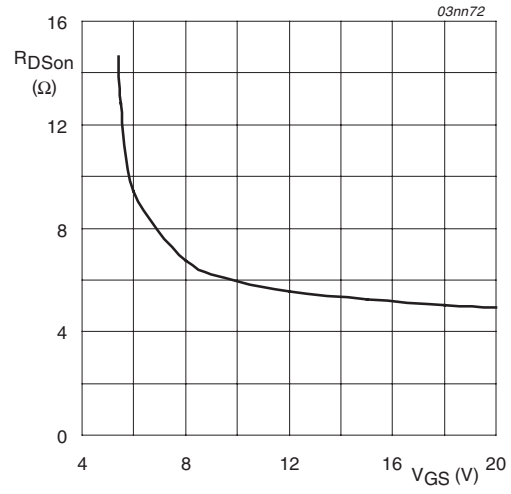

$T_j = 25^\circ\text{C}; I_D = 50\text{A}$

Fig 6. Drain-source on-state resistance as a function of gate-source voltage; typical values

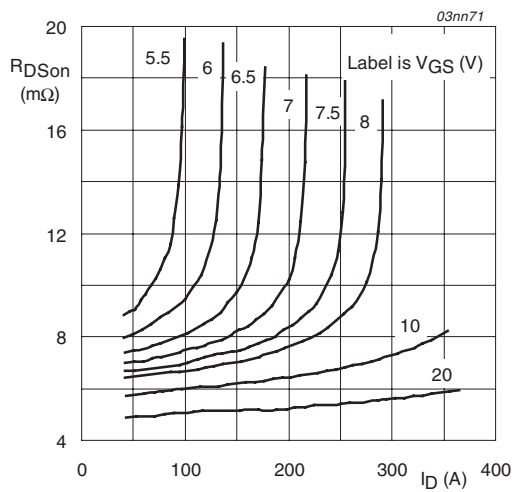

$T_j = 25^\circ\text{C}; t_p = 300\mu\text{s}$

Fig 7. Drain-source on-state resistance as a function of drain current; typical values

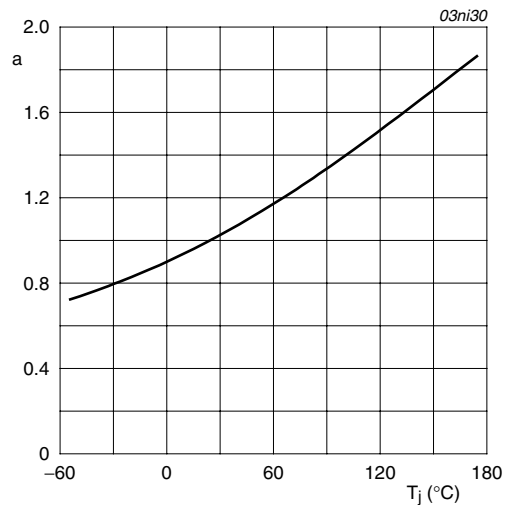

$$a = \frac{R_{DSon}}{R_{DSon(25^\circ\text{C})}}$$

Fig 8. Normalized drain-source on-state resistance factor as a function of junction temperature

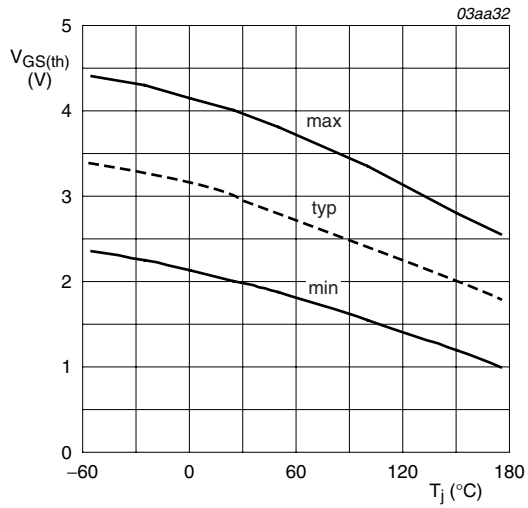

$I_D = 1\text{mA}; V_{DS} = V_{GS}$

Fig 9. Gate-source threshold voltage as a function of junction temperature

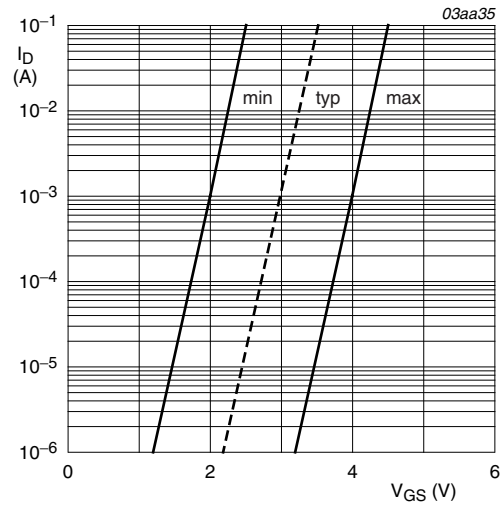

$T_j = 25^\circ\text{C}; V_{DS} = 5\text{V}$

Fig 10. Sub-threshold drain current as a function of gate-source voltage

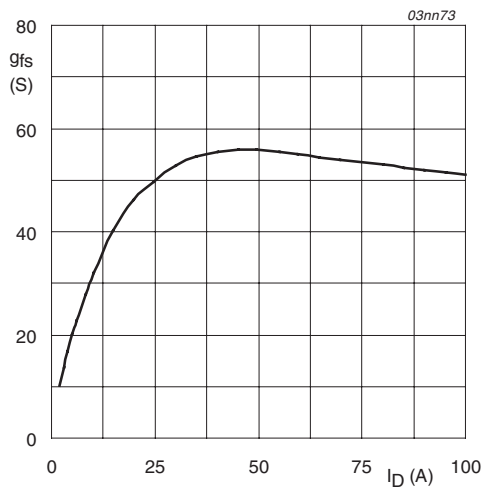

$T_j = 25^\circ\text{C}; V_{DS} = 25\text{V}$

Fig 11. Forward transconductance as a function of drain current; typical values

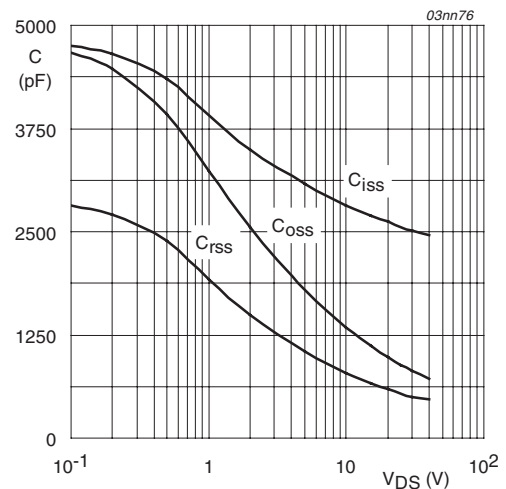

$V_{GS} = 0\text{V}; f = 1\text{MHz}$

Fig 12. Input, output and reverse transfer capacitances as a function of drain-source voltage; typical values

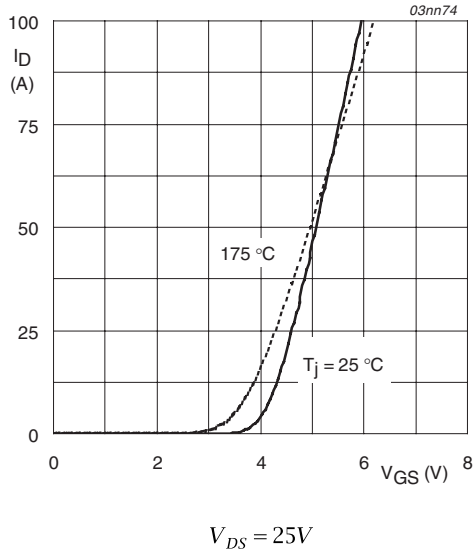

Fig 13. Transfer characteristics: drain current as a function of gate-source voltage; typical values

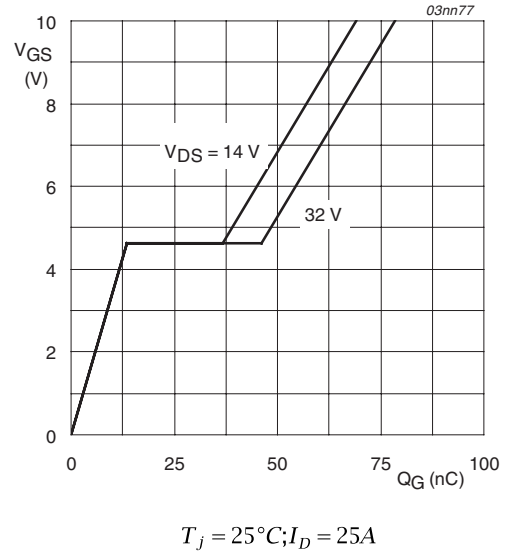

Fig 14. Gate-source voltage as a function of charge; typical values

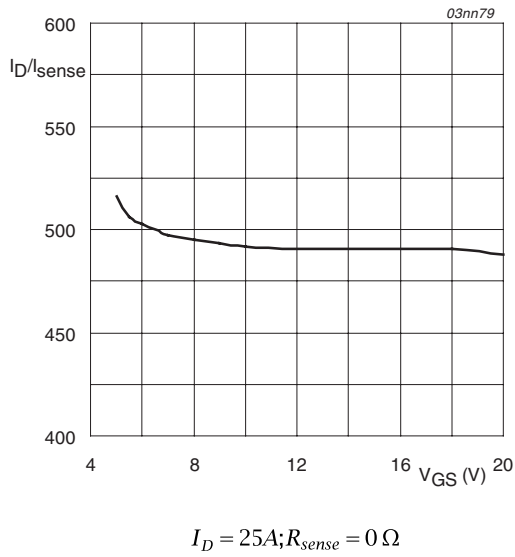

Fig 15. Drain-sense current ratio as a function of gate-source voltage; typical values

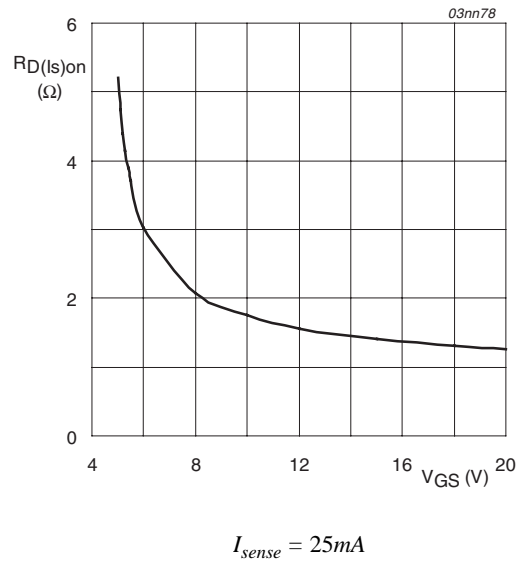

Fig 16. Drain-sense current on-state resistance as a function of gate-source voltage; typical values

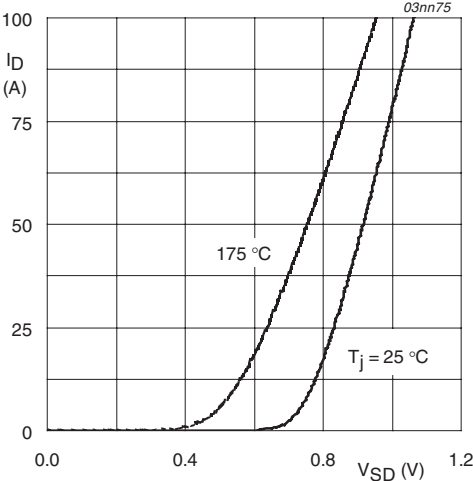

Fig 17. Drain current as a function of source-drain diode voltage; typical values

7. Package outline

Plastic single-ended surface-mounted package (D2PAK); 5 leads (one lead cropped)

SOT426

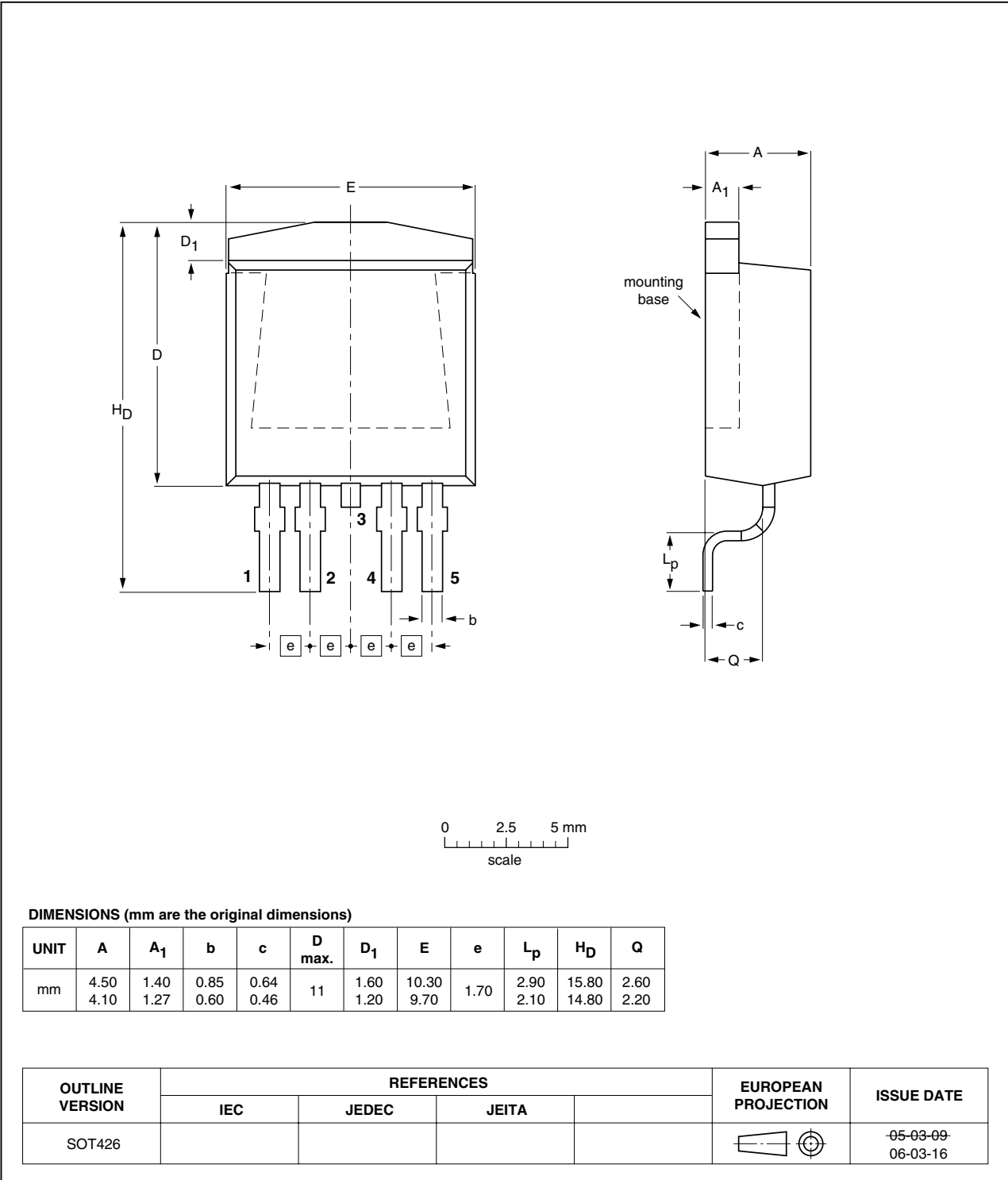

Fig 18. Package outline SOT426 (D2PAK)

8. Revision history

Table 7. Revision history

Document ID	Release date	Data sheet status	Change notice	Supersedes
BUK7108-40AIE_3	20090219	Product data sheet	-	BUK71_7908_40AIE-02
Modifications:		<ul style="list-style-type: none"> The format of this data sheet has been redesigned to comply with the new identity guidelines of NXP Semiconductors. Legal texts have been adapted to the new company name where appropriate. Type number BUK7108-40AIE separated from data sheet BUK71_7908_40AIE-02. 		
BUK71_7908_40AIE-02 (9397 750 12086)	20031024	Product data sheet	-	BUK71_7908_40AIE-01
BUK71_7908_40AIE-01 (9397 750 11695)	20030819	Product data sheet	-	-

9. Legal information

9.1 Data sheet status

Document status ^{[1][2]}	Product status ^[3]	Definition
Objective [short] data sheet	Development	This document contains data from the objective specification for product development.
Preliminary [short] data sheet	Qualification	This document contains data from the preliminary specification.
Product [short] data sheet	Production	This document contains the product specification.

[1] Please consult the most recently issued document before initiating or completing a design.

[2] The term 'short data sheet' is explained in section "Definitions".

[3] The product status of device(s) described in this document may have changed since this document was published and may differ in case of multiple devices. The latest product status information is available on the Internet at URL <http://www.nxp.com>.

9.2 Definitions

Draft — The document is a draft version only. The content is still under internal review and subject to formal approval, which may result in modifications or additions. NXP Semiconductors does not give any representations or warranties as to the accuracy or completeness of information included herein and shall have no liability for the consequences of use of such information.

Short data sheet — A short data sheet is an extract from a full data sheet with the same product type number(s) and title. A short data sheet is intended for quick reference only and should not be relied upon to contain detailed and full information. For detailed and full information see the relevant full data sheet, which is available on request via the local NXP Semiconductors sales office. In case of any inconsistency or conflict with the short data sheet, the full data sheet shall prevail.

9.3 Disclaimers

General — Information in this document is believed to be accurate and reliable. However, NXP Semiconductors does not give any representations or warranties, expressed or implied, as to the accuracy or completeness of such information and shall have no liability for the consequences of use of such information.

Right to make changes — NXP Semiconductors reserves the right to make changes to information published in this document, including without limitation specifications and product descriptions, at any time and without notice. This document supersedes and replaces all information supplied prior to the publication hereof.

Suitability for use — NXP Semiconductors products are not designed, authorized or warranted to be suitable for use in medical, military, aircraft, space or life support equipment, nor in applications where failure or malfunction of an NXP Semiconductors product can reasonably be expected to result in personal injury, death or severe property or environmental damage. NXP Semiconductors accepts no liability for inclusion and/or use of NXP Semiconductors products in such equipment or applications and therefore such inclusion and/or use is at the customer's own risk.

Applications — Applications that are described herein for any of these products are for illustrative purposes only. NXP Semiconductors makes no representation or warranty that such applications will be suitable for the specified use without further testing or modification.

Quick reference data — The Quick reference data is an extract of the product data given in the Limiting values and Characteristics sections of this document, and as such is not complete, exhaustive or legally binding.

Limiting values — Stress above one or more limiting values (as defined in the Absolute Maximum Ratings System of IEC 60134) may cause permanent damage to the device. Limiting values are stress ratings only and operation of the device at these or any other conditions above those given in the Characteristics sections of this document is not implied. Exposure to limiting values for extended periods may affect device reliability.

Terms and conditions of sale — NXP Semiconductors products are sold subject to the general terms and conditions of commercial sale, as published at <http://www.nxp.com/profile/terms>, including those pertaining to warranty, intellectual property rights infringement and limitation of liability, unless explicitly otherwise agreed to in writing by NXP Semiconductors. In case of any inconsistency or conflict between information in this document and such terms and conditions, the latter will prevail.

No offer to sell or license — Nothing in this document may be interpreted or construed as an offer to sell products that is open for acceptance or the grant, conveyance or implication of any license under any copyrights, patents or other industrial or intellectual property rights.

9.4 Trademarks

Notice: All referenced brands, product names, service names and trademarks are the property of their respective owners.

TrenchMOS — is a trademark of NXP B.V.

10. Contact information

For more information, please visit: <http://www.nxp.com>

For sales office addresses, please send an email to: salesaddresses@nxp.com

11. Contents

1	Product profile	1
1.1	General description	1
1.2	Features and benefits	1
1.3	Applications	1
1.4	Quick reference data	1
2	Pinning information	2
3	Ordering information	2
4	Limiting values	3
5	Thermal characteristics	5
6	Characteristics	6
7	Package outline	12
8	Revision history	13
9	Legal information	14
9.1	Data sheet status	14
9.2	Definitions	14
9.3	Disclaimers	14
9.4	Trademarks	14
10	Contact information	14

Please be aware that important notices concerning this document and the product(s) described herein, have been included in section 'Legal information'.



© NXP B.V. 2009.

All rights reserved.

For more information, please visit: <http://www.nxp.com>

For sales office addresses, please send an email to: salesaddresses@nxp.com

Date of release: Rev. 03 — 19 February 2009

Document identifier: BUK7108-40AIE_3