

1 如何更新 i.MXRT10xx 板载调试器的固件

多款 NXP i.MX RT10xx 系列的开发板是基于 LPC4322 MCU 开发的调试电路。除了默认固件外，该电路还可以使用基于 NXP 的 CMSIS-DAP 专有固件，该固件也支持 SWO 功能，也被称为 LPC-Link2。另外，固件可以提供除了拖拽以外的高性能 flash 烧录。LPC4322 调试电路还支持了 SEGGER 公司 J-Link 的测试版本。i.MX RT10xx EVK 出厂被烧录为基于 OpenSDA 的 CMSIS-DAP，同时拥有拖拽烧录的能力，但是它可以选择运行以上任意三种固件。

需要注意的是，只有 OpenSDA 固件版本（出厂默认固件）才能使能供电功能。

当使用其他版本之外的固件时，需要使用其他的供电端口供电，比如说桶形供电端子 J1 或者 USB1 接口。更多的电源选择的信息，可以阅读硬件使用指南（Hardware User's Guide）。当使用 USB1 进行供电时，需要确保供电设备可以提供至少 500mA 来保证设备在高供电应用中顺利运行（如图像的背光显示）。

本文档介绍了板载调试器如何烧录成 LINK2-CMSIS 或者 J-Link 固件以及如何切换回 OpenSDA 固件（默认固件）。

文档中使用的硬件是 MIMXRT1060-EVK (Rev.A1) 开发板，但可以为应用基于 LPC4322 调试器的 i.MX RT10xx EVK 系列的开发板做参考。升级固件所用到的工具叫做 LPCScrypt，可在 [LPCScrypt v2.1.2](#) 找到。当用 LPCScrypt 烧录 J-Link 固件的时候，可能需要从 [SEGGER](#) 中下载固件（因为经常需要升级到他们的固件）。

表 1 给出了三种固件功能的对比：

表 1. 对比三种固件

	OpenSDA Daplink	LPC-Link2 CMSIS-DAP	LPC-Link2 Segger J-link
USB 供电（自动连接到目标控制器）	√	X	X
SWD debug with MCUXpresso IDE	√	√	√
SWO trace/profiling/ITM	X	√	X
Drag/drop programming	√	X	X
UART-USB (VCOM)	√	√	√
Flash programming 速度 (relative to OpenSDA)	1X	3-4X	4X

2 烧录 LINK2 CMSIS

1. 下载安装 [LPCScrypt](#)。
2. 使用跳线帽短接 J42 来开启 DFU boot 模式。

目录

1	如何更新 i.MXRT10xx 板载调试器的固件	1
2	烧录 LINK2 CMSIS	1
3	烧录 J-Link	2
4	切换为 OpenSDA 固件 (出厂默认固件)	3
4.1	下载固件	3
5	版本历史	5





图 1. DFU 跳线

- 通过调试器 USB 接口上电 (MIMXRT1060-EVK 上的 J41)，然后连接 LINK 2 到 LPC 4322 调试接口 J34。调整 J1 跳线帽到 3-4。
- 找到安装路径，运行 program_CMSIS.cmd 文件。默认的路径为：

```
C:\nxp\LPCScript_2.1.2_57\scripts
```

aeskey.cmd	2018/6/19 9:51	Windows Command ...	1 KB
boot_lpcscript.cmd	2018/6/19 9:51	Windows Command ...	2 KB
encrypt_and_program.cmd	2018/6/19 9:51	Windows Command ...	1 KB
encrypt_and_program.scy	2018/6/19 9:51	SCY File	1 KB
ListComPorts.cmd	2018/6/19 9:51	Windows Command ...	1 KB
ListLPCComPorts.cmd	2018/6/19 9:51	Windows Command ...	1 KB
LPCScript_CLI.cmd	2018/6/19 9:51	Windows Command ...	2 KB
program_CMSIS.cmd	2018/6/19 9:51	Windows Command ...	5 KB
program_JLINK.cmd	2018/6/19 9:51	Windows Command ...	4 KB

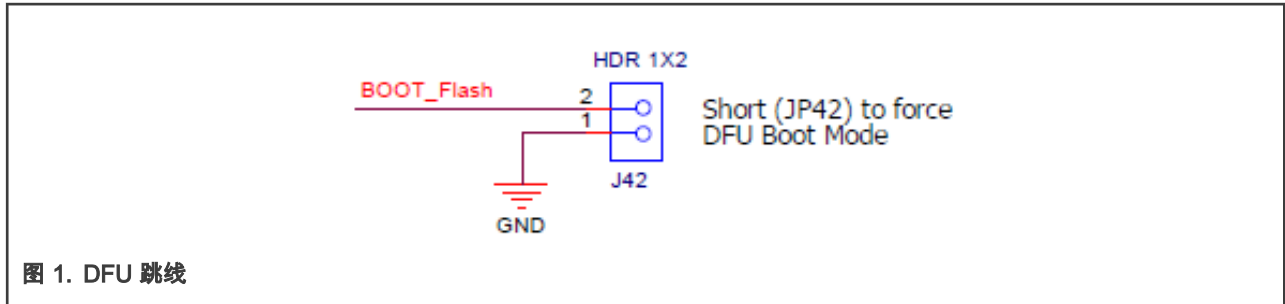
图 2. 选择 program_cmsis

- 根据屏幕的指示，按任意按键加载程序，programmed successfully 表明固件升级成功。

```
LPCScript - CMSIS-DAP firmware programming script v2.0.0 June 2018.

Connect an LPC-Link2 or LPCXpresso V2/V3 Board via USB then press Space.

Press any key to continue . . .

Booting LPCScript target with "LPCScript_218.bin.hdr"
LPCScript target booted

Programming LPCXpresso V2/V3 with "LPC432x_IAP_CMSIS_DAP_V5_183.bin"

- LPCXpresso V2/V3 programmed successfully and has the unique ID: FRAZCQER
- To use: remove DFU link and reboot.

Connect Next Board then press Space (or CTRL-C to Quit)
```

图 3. CMSIS 固件烧录结果

- 如 图 3 所示，页面将显示更新成功的提示。接着，移除 J42 跳线帽后，重新给开发板上电。

3 烧录 J-Link

升级固件为 J-Link 的方法和 LINK2 CMSIS 相同，除了运行的文件是 program_JLINK.cmd。



图 5 显示了成功升级所显示的结果。



4 切换为 OpenSDA 固件 (出厂默认固件)

升级完固件为 LINK2 CMSIS 或者 J-Link 之后，可以根据下面的方法切换回默认固件。这个方法大致可以分为两步：

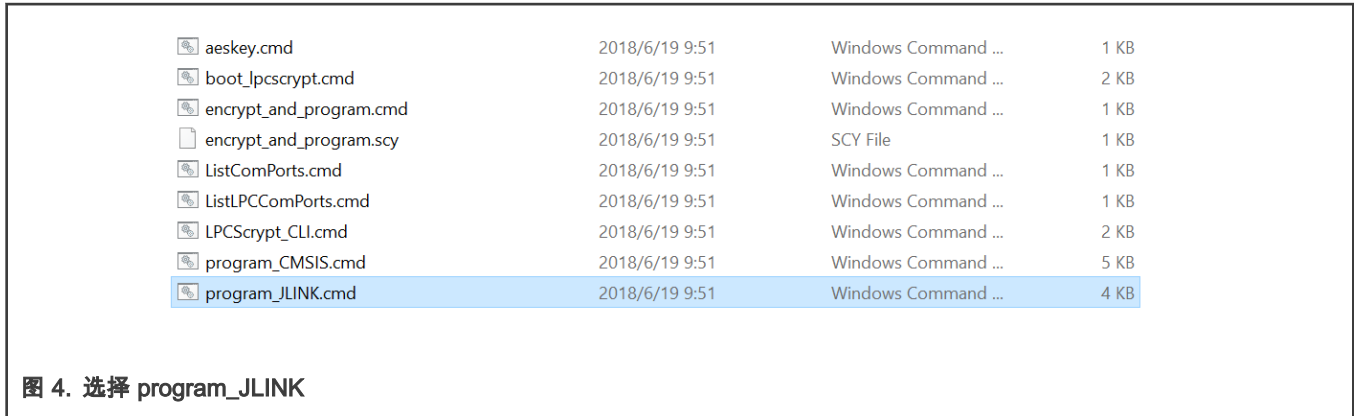
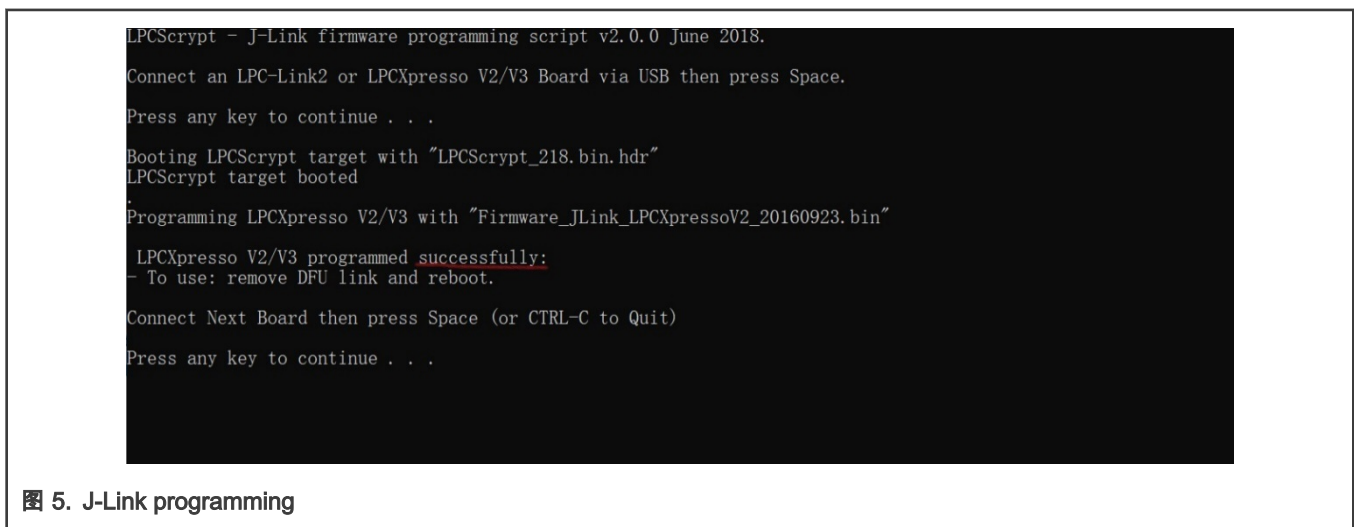
1. 下载 Bootloader。
2. 用拖拽方法烧录 OpenSDA 固件。

4.1 下载固件

1. 从 [OpenSDA Serial and Debug Adapter](#) 下载 bootloader 和默认固件。
2. 在下拉列表中选择 MIMXRT1060-EVK 开发板，如 [图 6](#) 所示：

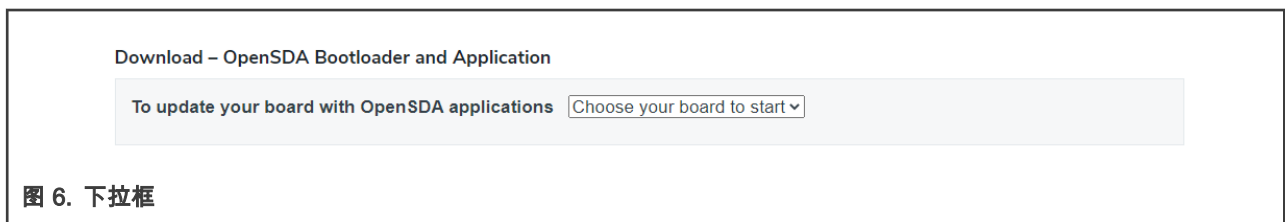

3. 选中开发板之后，屏幕上会显示需要下载的固件：



图 7. 可选固件

- 把 bootloader 二进制文件放到一个临时文件夹 Temp 里, 如 c:\Temp\bootloader。
- 使用跳线帽连接 J42 进入 DFU 模式, 然后给板子重新上电。
- 打开命令窗口然后进入 LPCS crypt 文件夹下的 bin 文件然后运行 boot_lpcscrypt.cmd:

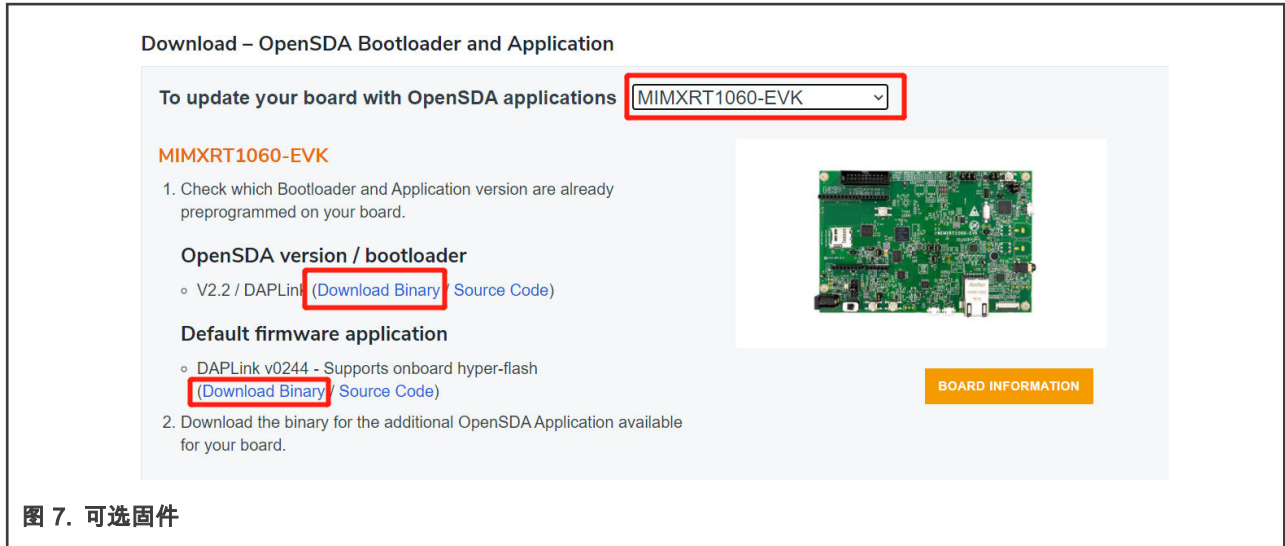

图 8. 结果

- 输入命令:

```
lpcscrypt erase all
```

可能会有报错提示但可以忽略。

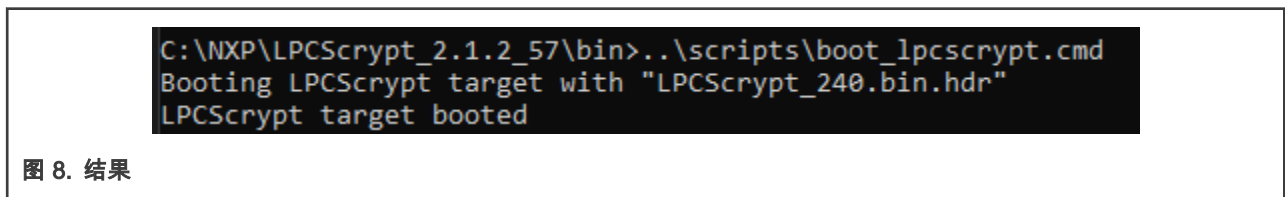
- 输入命令把 bootloader 加载到 BankA (地址 0x1a000000):

```
lpcscrypt program c:\Temp\bootloader\lpc4322_b1_crc_20180810.bin 0x1a000000
```

- 几秒后, 结果如 图 9 所示。



图 9. 信息

- 拔掉跳线, 重新上电。开发板会在计算机上产生一个新的驱动 **MAINTENANCE**。
- 把下载的二进制文件拖拽进 MAINTENANCE 驱动。J41 旁的 LED 会闪烁几次。有 30 秒的时间等待 boot loading/固件升级。然后驱动名称会变为具体的开发板名称, 如 RT1060-EVK。

这时默认固件升级已经完成。

5 版本历史

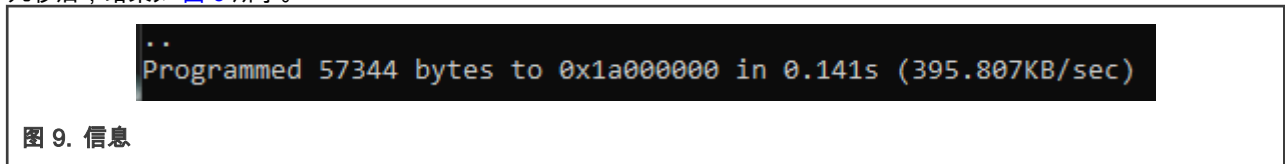
版本号	日期	描述
0	04/2021	首次发布

How To Reach Us

Home Page:

nxp.com

Web Support:

nxp.com/support

Information in this document is provided solely to enable system and software implementers to use NXP products. There are no express or implied copyright licenses granted hereunder to design or fabricate any integrated circuits based on the information in this document. NXP reserves the right to make changes without further notice to any products herein.

NXP makes no warranty, representation, or guarantee regarding the suitability of its products for any particular purpose, nor does NXP assume any liability arising out of the application or use of any product or circuit, and specifically disclaims any and all liability, including without limitation consequential or incidental damages. "Typical" parameters that may be provided in NXP data sheets and/or specifications can and do vary in different applications, and actual performance may vary over time. All operating parameters, including "typicals," must be validated for each customer application by customer's technical experts. NXP does not convey any license under its patent rights nor the rights of others. NXP sells products pursuant to standard terms and conditions of sale, which can be found at the following address: nxp.com/SalesTermsandConditions.

Right to make changes - NXP Semiconductors reserves the right to make changes to information published in this document, including without limitation specifications and product descriptions, at any time and without notice. This document supersedes and replaces all information supplied prior to the publication hereof.

Security — Customer understands that all NXP products may be subject to unidentified or documented vulnerabilities. Customer is responsible for the design and operation of its applications and products throughout their lifecycles to reduce the effect of these vulnerabilities on customer's applications and products. Customer's responsibility also extends to other open and/or proprietary technologies supported by NXP products for use in customer's applications. NXP accepts no liability for any vulnerability. Customer should regularly check security updates from NXP and follow up appropriately. Customer shall select products with security features that best meet rules, regulations, and standards of the intended application and make the ultimate design decisions regarding its products and is solely responsible for compliance with all legal, regulatory, and security related requirements concerning its products, regardless of any information or support that may be provided by NXP. NXP has a Product Security Incident Response Team (PSIRT) (reachable at PSIRT@nxp.com) that manages the investigation, reporting, and solution release to security vulnerabilities of NXP products.

NXP, the NXP logo, NXP SECURE CONNECTIONS FOR A SMARTER WORLD, COOLFLUX, EMBRACE, GREENCHIP, HITAG, ICODE, JCOP, LIFE, VIBES, MIFARE, MIFARE CLASSIC, MIFARE DESFire, MIFARE PLUS, MIFARE FLEX, MANTIS, MIFARE ULTRALIGHT, MIFARE4MOBILE, MIGLO, NTAG, ROADLINK, SMARTLX, SMARTMX, STARPLUG, TOPFET, TRENCHMOS, UCODE, Freescale, the Freescale logo, Altivec, CodeWarrior, ColdFire, ColdFire+, the Energy Efficient Solutions logo, Kinetis, Layerscape, MagniV, mobileGT, PEG, PowerQUICC, Processor Expert, QorIQ, QorIQ Qonverge, SafeAssure, the SafeAssure logo, StarCore, Symphony, VortiQa, Vybrid, Airfast, BeeKit, BeeStack, CoreNet, Flexis, MXC, Platform in a Package, QUICC Engine, Tower, TurboLink, EdgeScale, EdgeLock, eIQ, and Immersive3D are trademarks of NXP B.V. All other product or service names are the property of their respective owners. AMBA, Arm, Arm7, Arm7TDMI, Arm9, Arm11, Artisan, big.LITTLE, Cordio, CoreLink, CoreSight, Cortex, DesignStart, DynamIQ, Jazelle, Keil, Mali, Mbed, Mbed Enabled, NEON, POP, RealView, SecurCore, Socrates, Thumb, TrustZone, ULINK, ULINK2, ULINK-ME, ULINK-PLUS, ULINKpro, μ Vision, Versatile are trademarks or registered trademarks of Arm Limited (or its subsidiaries) in the US and/or elsewhere. The related technology may be protected by any or all of patents, copyrights, designs and trade secrets. All rights reserved. Oracle and Java are registered trademarks of Oracle and/or its affiliates. The Power Architecture and Power.org word marks and the Power and Power.org logos and related marks are trademarks and service marks licensed by Power.org.

© NXP B.V. 2021.

All rights reserved.

For more information, please visit: <http://www.nxp.com>

For sales office addresses, please send an email to: salesaddresses@nxp.com

Date of release: 04/2021

Document identifier: AN13206

