



# 32位微控制器

## MPC555

Last Updated: Apr 9, 2022

MPC555 MCU提供高速解决方案，非常适合汽车应用(如发动机和传动控制)，以及机器人和航空电子控制。

- 加速支持复杂应用所需的高级算法
- 包括高性能数据处理能力
- 允许在生产周期末期灵活地更改或升级产品
- 开发成本低，进入市场的周期更短

## MPC555 Block Diagram Block Diagram

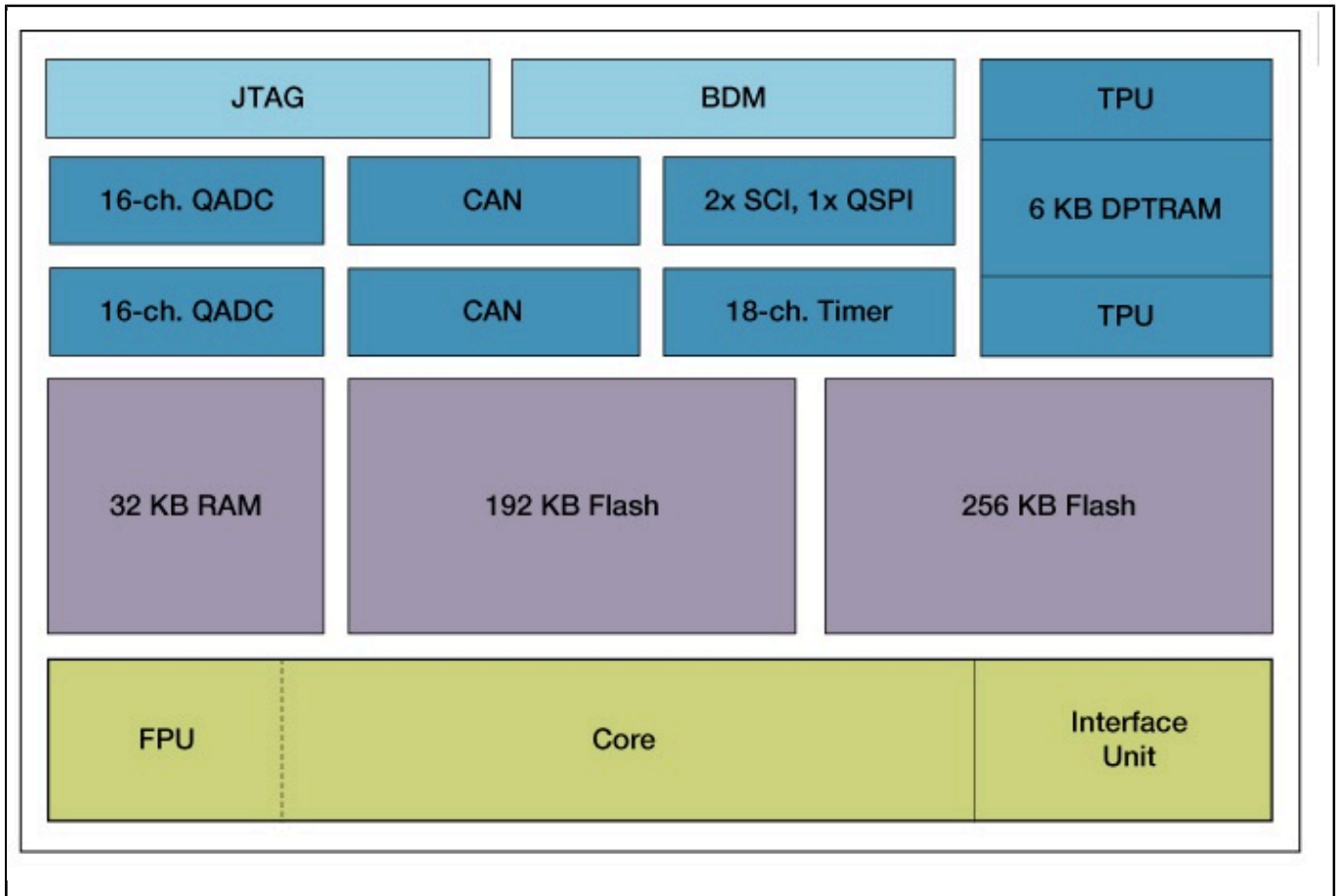

View additional information for [32位微控制器](#).

**Note:** The information on this document is subject to change without notice.

**www.nxp.com**

NXP and the NXP logo are trademarks of NXP B.V. All other product or service names are the property of their respective owners. The related technology may be protected by any or all of patents, copyrights, designs and trade secrets. All rights reserved. © 2024 NXP B.V.