



# Azurewave Wi-Fi® 5 (802.11ac) + Bluetooth® chipset-based M.2 evaluation board: AW-CM358MA

## AW-CM358

Last Updated: Apr 4, 2024

The AW-CM358MA is a highly integrated NXP 88W8987 chipset-based WLAN and Bluetooth module, which support 802.11a/b/g/n/ac 1x1 and Bluetooth 5 combo module. It enables a high performance. Cost effective, low power, compact solution. The host interface supports SDIO for WLAN and UART for Bluetooth.

## Azurewave AW-CM358MA block diagram Block Diagram

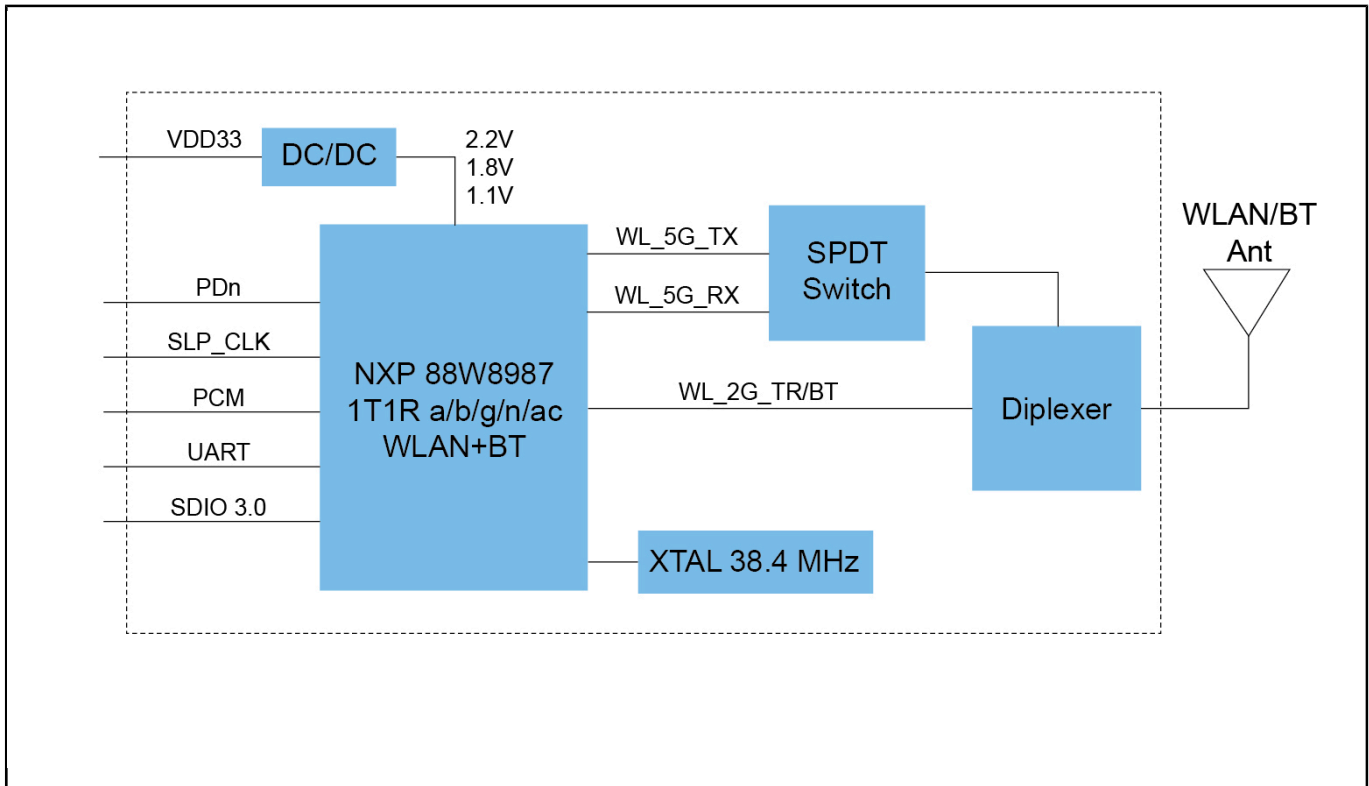

View additional information for [Azurewave Wi-Fi® 5 \(802.11ac\) + Bluetooth® chipset-based M.2 evaluation board: AW-CM358MA](#).

**Note:** The information on this document is subject to change without notice.

**www.nxp.com**

NXP and the NXP logo are trademarks of NXP B.V. All other product or service names are the property of their respective owners. The related technology may be protected by any or all of patents, copyrights, designs and trade secrets. All rights reserved. © 2025 NXP B.V.