



SBC Gen2 with High-Speed CAN and LIN

MC33903

Last Updated: Jun 8, 2022

The NXP® MC33903 is part of a second generation family of system basis chips, combining multiple features and enhanced module design.

- The MC33903 works as an advanced power management unit for the MCU and additional integrated circuits such as sensors and CAN transceivers
- Built-in enhanced high-speed CAN interface (ISO11898-2 and -5), with local and bus failure diagnostics, protection and fail-safe operation mode.
- The SBC may include zero, one or two LIN 2.1 interfaces with LIN output pin switches.

Freescale MC33903 Battery Management Block Diagram Block Diagram

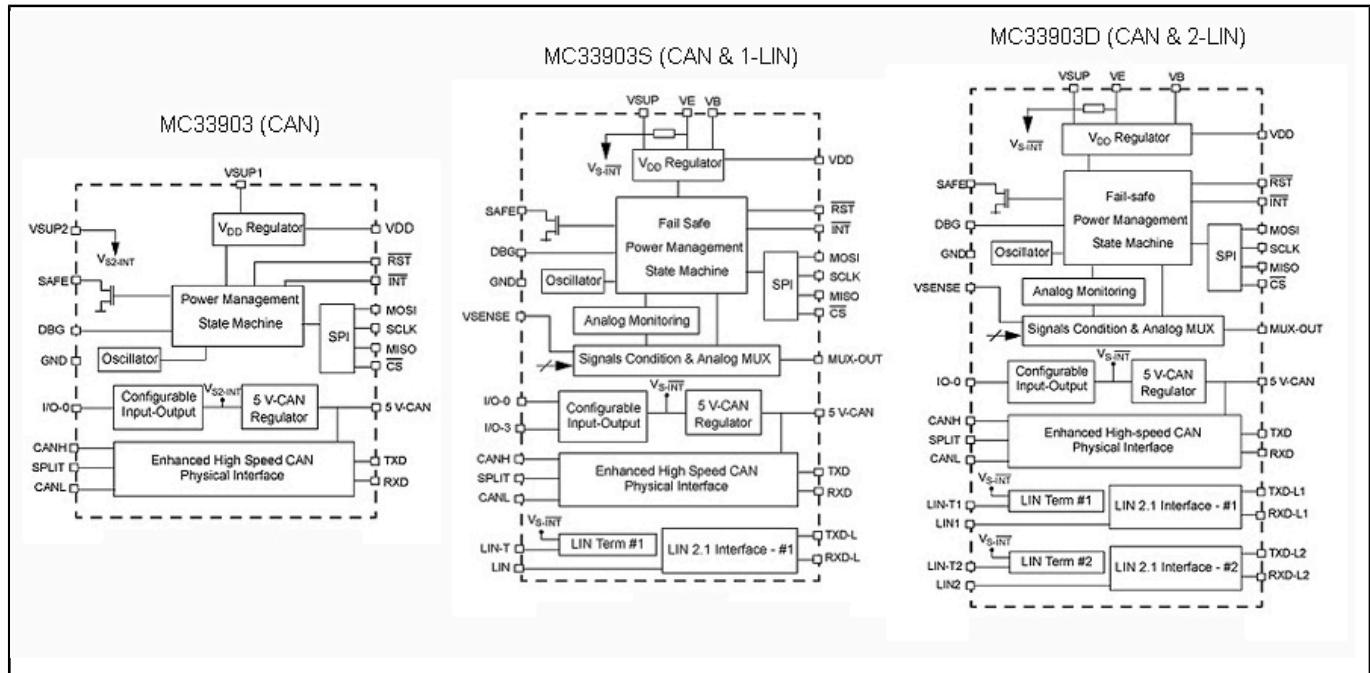

View additional information for [SBC Gen2 with High-Speed CAN and LIN](#).

Note: The information on this document is subject to change without notice.

www.nxp.com

NXP and the NXP logo are trademarks of NXP B.V. All other product or service names are the property of their respective owners. The related technology may be protected by any or all of patents, copyrights, designs and trade secrets. All rights reserved. © 2022 NXP B.V.