



# Battery Sensor with LIN for 12 V Lead-acid Batteries

## MM912\_637

Last Updated: Jul 8, 2022

The NXP® MM912\_637 battery sensors are integrated battery monitoring devices that allow simultaneous measurement of current and voltage for precise determination of SOC (State of Charge), SOH (State of Health), and other parameters.

- The integrated temperature sensor combined with the close proximity to the battery allows battery temperature measurement
- Multiple application-specific hardware blocks reduce MCU overhead and related power consumption
- Configurable low-power modes with automated battery state observation and sophisticated wake-up capability further reduce current consumption
- The integrated LIN 2.1 interface allows communication and control of battery monitoring functions

# MM912 Block Diagram Block Diagram

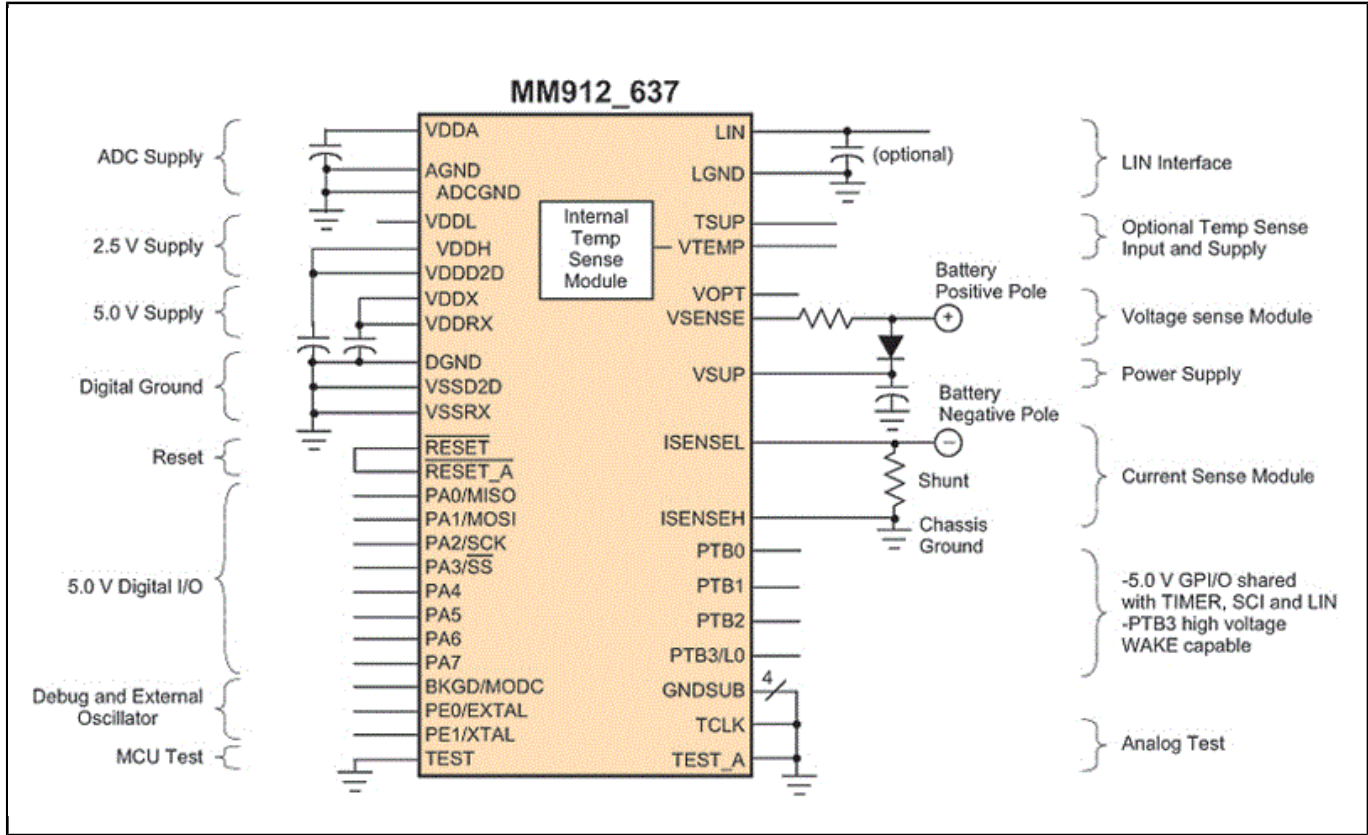

View additional information for [Battery Sensor with LIN for 12 V Lead-acid Batteries](#).

Note: The information on this document is subject to change without notice.

[www.nxp.com](http://www.nxp.com)

NXP and the NXP logo are trademarks of NXP B.V. All other product or service names are the property of their respective owners. The related technology may be protected by any or all of patents, copyrights, designs and trade secrets. All rights reserved. © 2022 NXP B.V.