



PowerQUICC® Processor with CPM (1 SCC, 2 SMC), 10/100 Ethernet

MPC855T

Not Recommended for New Designs

This page contains information on a product that is not recommended for new designs.

Last Updated: Sep 11, 2024

The MPC855T is a versatile one-chip integrated microprocessor and peripheral combination designed for lower cost access equipment that requires fast ethernet support capable of 100 Mbps. This member of the MPC860 PowerQUICC™ family combines an MPC8xx core processor along with NXP® Semiconductors's own Communication Processor Module, a separate RISC engine specifically designed to offload communication tasks from the MPC8xx core.

It differs from existing PowerQUICC® family members in that the MPC855T features only one Serial Communications Controller instead of four. In addition, the MPC855T is manufactured in Our 0.32μ process technology allowing for 3.3 volt core operation and 3.3 volt I/O.

The MPC855T is packaged in a 357-pin BGA package and is footprint-compatible with existing MPC860 PowerQUICC designs. The MPC855T is also available at 50, 66, and 80 MHz and is supported by over 50 third party tool vendors.

MPC855T_BLKDIAG Block Diagram

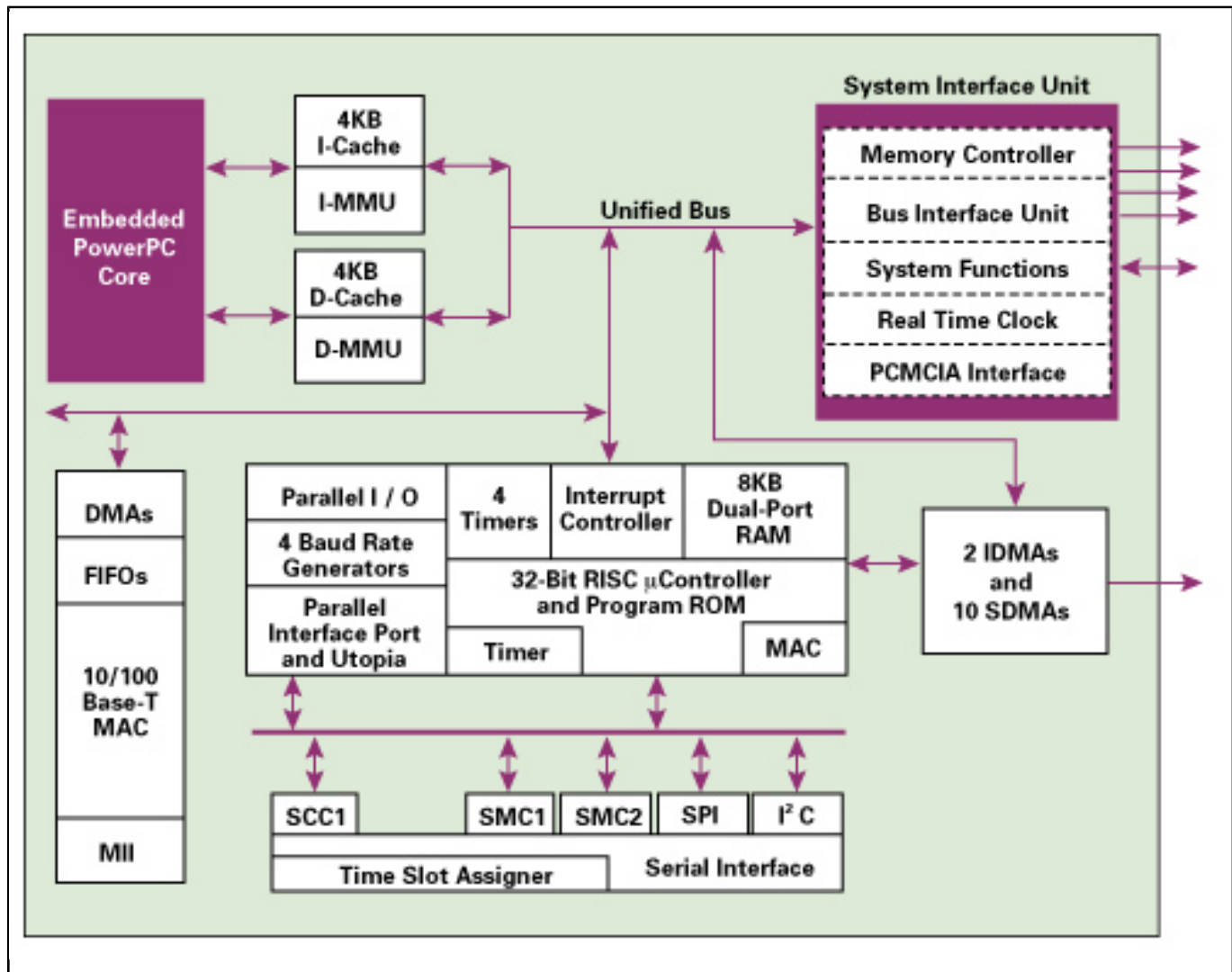

View additional information for [PowerQUICC® Processor with CPM \(1 SCC, 2 SMC\), 10/100 Ethernet](#).

Note: The information on this document is subject to change without notice.

www.nxp.com

NXP and the NXP logo are trademarks of NXP B.V. All other product or service names are the property of their respective owners. The related technology may be protected by any or all of patents, copyrights, designs and trade secrets. All rights reserved. © 2025 NXP B.V.