



I3C, I²C–Bus, 2.0 °C Accuracy, Digital Temperature Sensor

P3T2030xUK

Last Updated: Jun 2, 2026

P3T2030xUK is a temperature-to-digital converter from -40 °C to +125 °C range. It uses an on-chip band gap temperature sensor and A-to-D conversion technique with an overtemperature detection.

The temperature register always stores a 12 bit two's complement data, giving a temperature resolution of 0.0625 °C.

P3T2030xUK can be configured for different operation conditions: continuous conversion and one-shot. The P3T2030xUK is available in WLCSP4 package and has 8 factory-programmed device address options.

P3T2030 Block Diagram

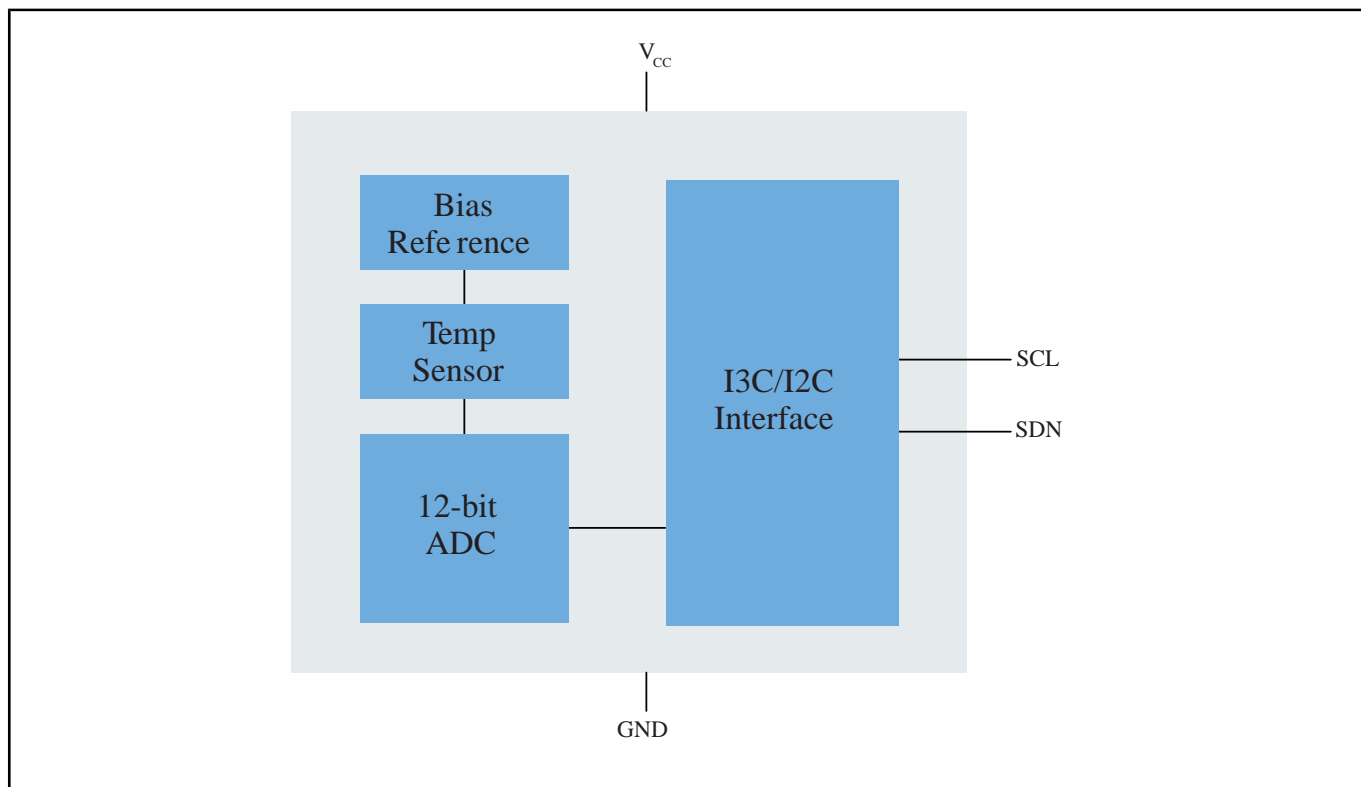

View additional information for [I3C, I²C-Bus, 2.0 °C Accuracy, Digital Temperature Sensor](#).

Note: The information on this document is subject to change without notice.

www.nxp.com

NXP and the NXP logo are trademarks of NXP B.V. All other product or service names are the property of their respective owners. The related technology may be protected by any or all of patents, copyrights, designs and trade secrets. All rights reserved. © 2026 NXP B.V.