



2-Bit I²C-Bus LED Dimmer

PCA9530

Last Updated: Sep 5, 2024

The PCA9530 is a 2-bit I²C-bus and SMBus I/O expander optimized for dimming LEDs in 256 discrete steps for Red/Green/Blue (RGB) color mixing and backlight applications.

The PCA9530 contains an internal oscillator with two user programmable blink rates and duty cycles coupled to the output PWM. The LED brightness is controlled by setting the blink rate high enough (> 100 Hz) that the blinking cannot be seen and then using the duty cycle to vary the amount of time the LED is on and thus the average current through the LED.

The initial setup sequence programs the two blink rates/duty cycles for each individual PWM. From then on, only one command from the bus controller is required to turn individual LEDs ON, OFF, BLINK RATE 1 or BLINK RATE 2. Based on the programmed frequency and duty cycle, BLINK RATE 1 and BLINK RATE 2 will cause the LEDs to appear at a different brightness or blink at periods up to 1.69 seconds. The open-drain outputs directly drive the LEDs with maximum output sinks current of 25 mA per bit and 50 mA per package.

To blink LEDs at periods greater than 1.69 seconds, the bus controller (MCU, MPU, DSP, chipset, etc.) must send repeated commands to turn the LED on and off as is currently done when using normal I/O Expanders like the NXP Semiconductors PCF8574 or PCA9554. Any bits not used for controlling the LEDs can be used for General Purpose parallel Input/Output (GPIO) expansion which provides a simple solution when additional I/O is needed for ACPI power switches, sensors, push buttons, alarm monitoring, fans, etc.

The active LOW hardware reset pin (RESET) and Power-On Reset (POR) initialize the registers to their default state causing the bits to be set HIGH (LED off).

One hardware address pin on the PCA9530 allows two devices to operate on the same bus.

PCA9530 Block Diagram Block Diagram

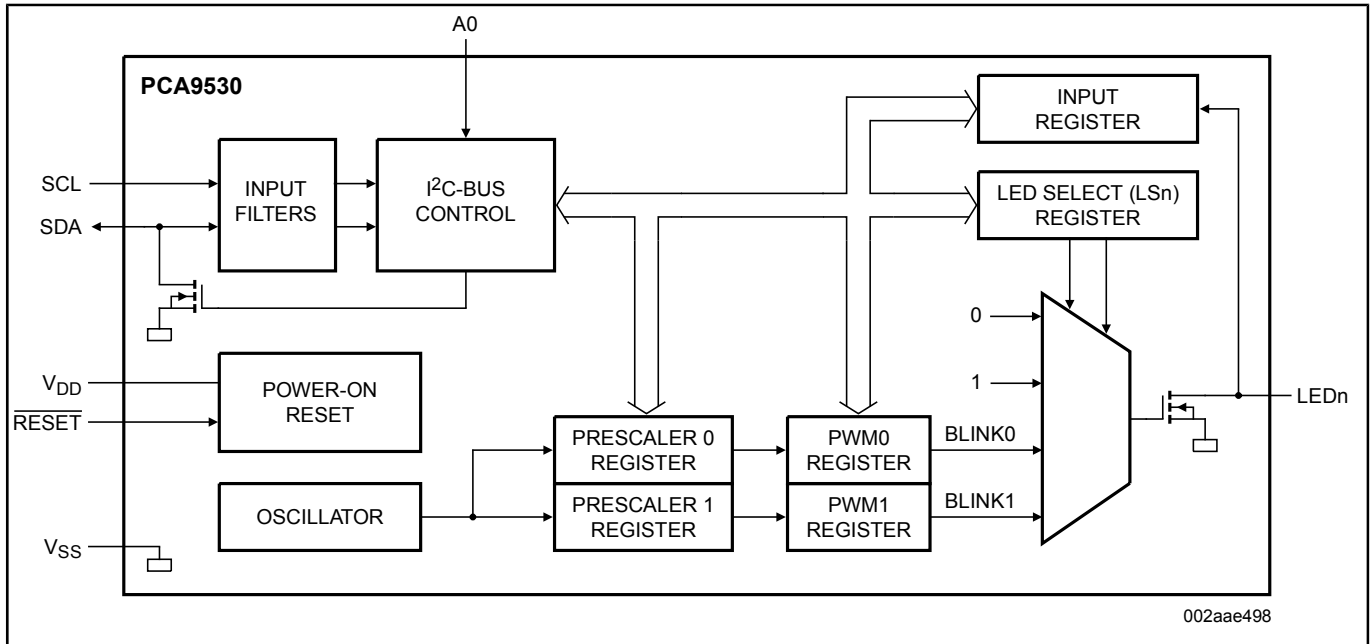

Block diagram: PCA9530D, PCA9530DP Block Diagram

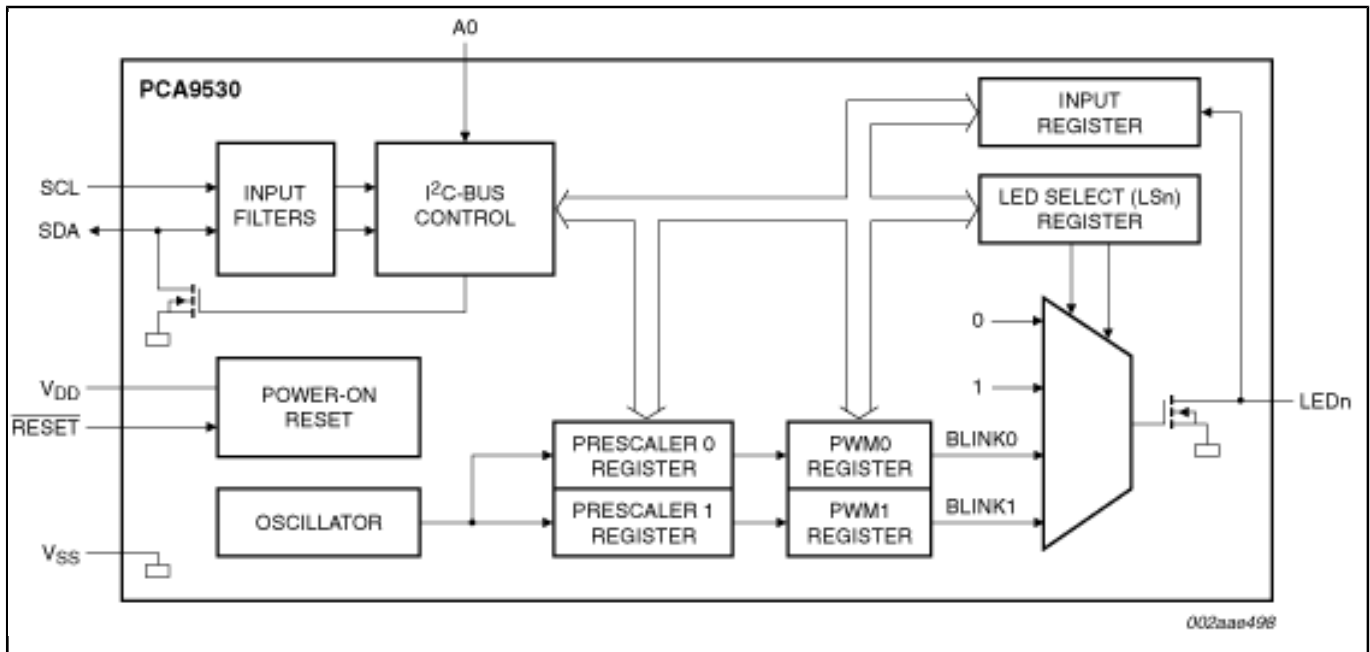

View additional information for [2-Bit I²C-Bus LED Dimmer](#).

Note: The information on this document is subject to change without notice.

www.nxp.com

NXP and the NXP logo are trademarks of NXP B.V. All other product or service names are the property of their respective owners. The related technology may be protected by any or all of patents, copyrights, designs and trade secrets. All rights reserved. © 2024 NXP B.V.