



SuperSpeed USB 3.0 Redriver

PTN36241G

Last Updated: Oct 25, 2023

PTN36241G is a very small, low power SuperSpeed USB 3.0 redriver IC that enhances signal quality by performing receive equalization on the deteriorated input signal followed by transmit de-emphasis maximizing system link performance for mobile applications. With its superior differential signal conditioning and enhancement capability, the device delivers significant flexibility and performance scaling for various systems with different PCB trace and cable channel conditions and still benefit from optimum power consumption.

PTN36241G is a dual-channel device that supports data signaling rate of 5 Gbit/s through each channel. The data flow of one channel is facing the USB host, and another channel is facing the USB peripheral or device. Each channel consists of a high-speed Transmit (Tx) differential lane and a high-speed Receive (Rx) differential lane.

PTN36241G has built-in advanced power management capability that enables significant power savings under various different USB 3.0 Low-power modes (U2/U3). It can detect link electrical conditions and can dynamically activate/de-activate internal circuitry and logic. The device performs these actions without host software intervention and conserves power.

PTN36241G is powered from a 1.8 V supply and is available in a small X2QFN12 package (1.25 mm × 2.1 mm × 0.35 mm) with 0.4 mm pitch.

PTN36241G Block Diagram

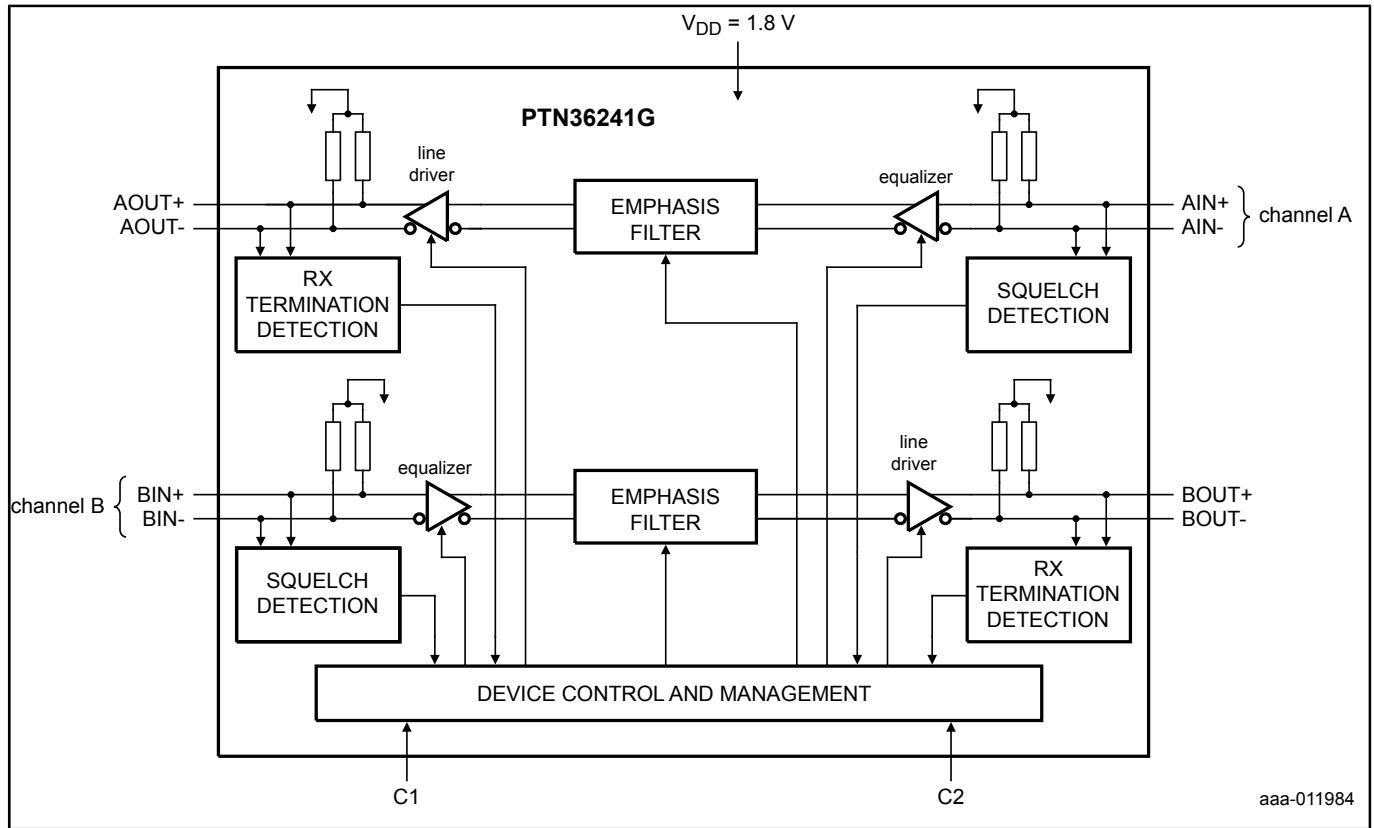

View additional information for [SuperSpeed USB 3.0 Redriver](#).

Note: The information on this document is subject to change without notice.

www.nxp.com

NXP and the NXP logo are trademarks of NXP B.V. All other product or service names are the property of their respective owners. The related technology may be protected by any or all of patents, copyrights, designs and trade secrets. All rights reserved. © 2023 NXP B.V.