



Type-C USB 3.1 Gen 1 and DisplayPort V1.2 Combo Redriver

PTN36502

Last Updated: Oct 25, 2023

PTN36502 is a Type-C USB 3.1 Gen 1/ DP1.2 combo redriver that is optimized for USB 3.1 Gen 1 and DisplayPort applications on either the Downstream Facing Port (DFP) or Upstream Facing Port (UFP) by following the four high-speed differential data flow to extend the signal reach.

PTN36502 addresses high-speed signal quality enhancement requirements for implementation of a USB Type-C interface on a platform that supports the VESA DisplayPort Alt Mode Standard v1.0a, which includes a DisplayPort Branch or Sink function.

PTN36502 has built-in advanced power management capability that enables significant power saving under USB 3.1 Gen 1 Low power modes (U2/U3). It can detect LFPS signaling and link electrical conditions and can dynamically activate/de-activate internal circuitry and logic.

PTN36502 is powered by a 1.8 V supply and it is available in a small thin HX2QFN24 package with 2.4 mm x 3.2 mm x 0.35 mm and 0.4 mm pitch.

PTN36502 Block Diagram

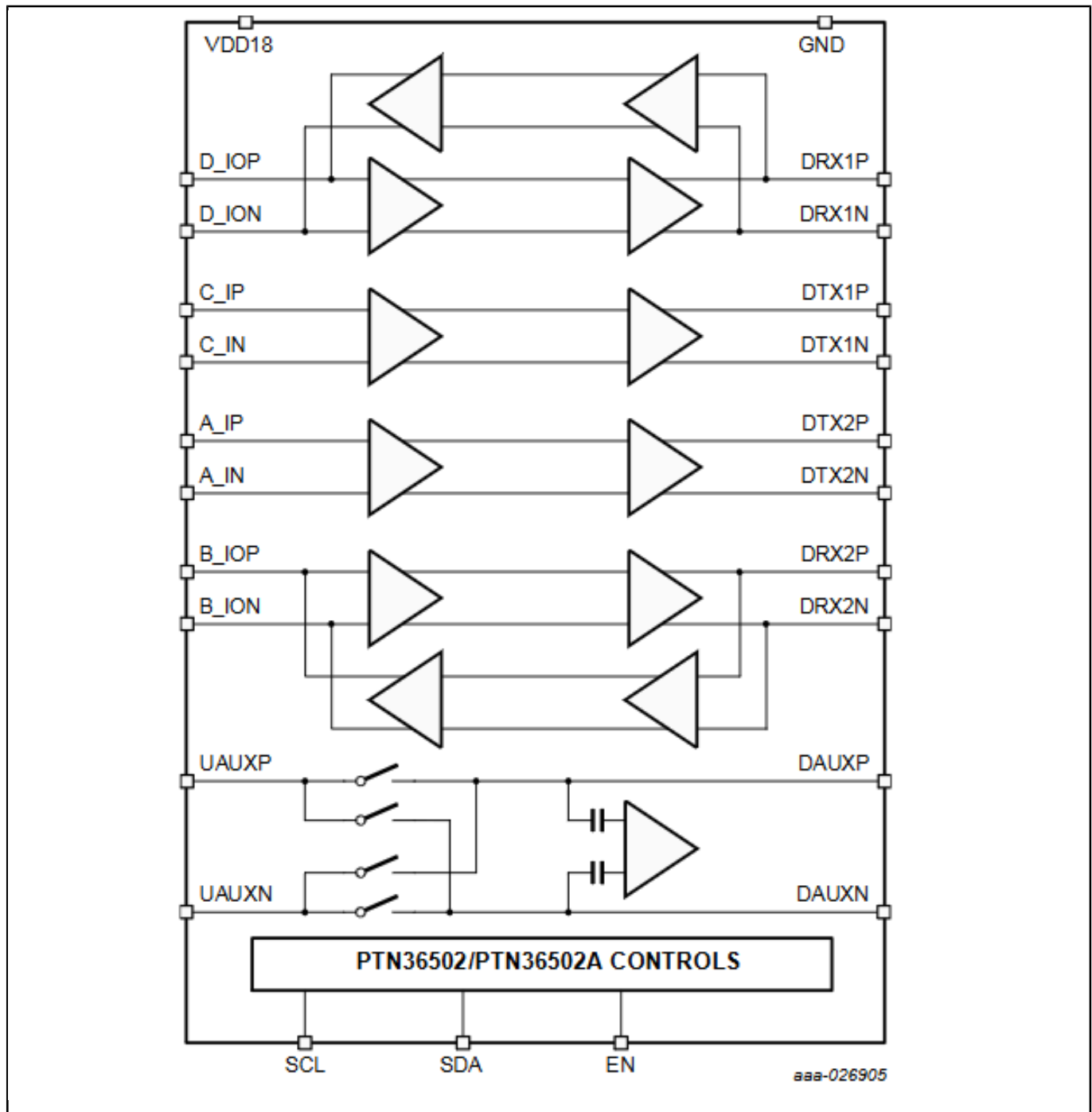

View additional information for [Type-C USB 3.1 Gen 1 and DisplayPort V1.2 Combo Redriver](#).

Note: The information on this document is subject to change without notice.

www.nxp.com

NXP and the NXP logo are trademarks of NXP B.V. All other product or service names are the property of their respective owners. The related technology may be protected by any or all of patents, copyrights, designs and trade secrets. All rights reserved. © 2023 NXP B.V.