



XA 16-Bit Microcontroller Family

PXAS37KBA

Last Updated: Mar 8, 2023

The XA-S3 device is a member of NXP® Semiconductors' XA (eXtended Architecture) family of high performance 16-bit single-chip microcontrollers.

The XA-S3 device combines many powerful peripherals on one chip. With its high performance A/D converter, timers/counters, watchdog, Programmable Counter Array (PCA), I²C interface, dual UARTs, and multiple general purpose I/O ports, it is suited for general multipurpose high performance embedded control functions.

Block diagram: PXAS30KBA, PXAS30KBBE, PXAS30KFA, PXAS37KBA, PXAS37KBBE
Block Diagram

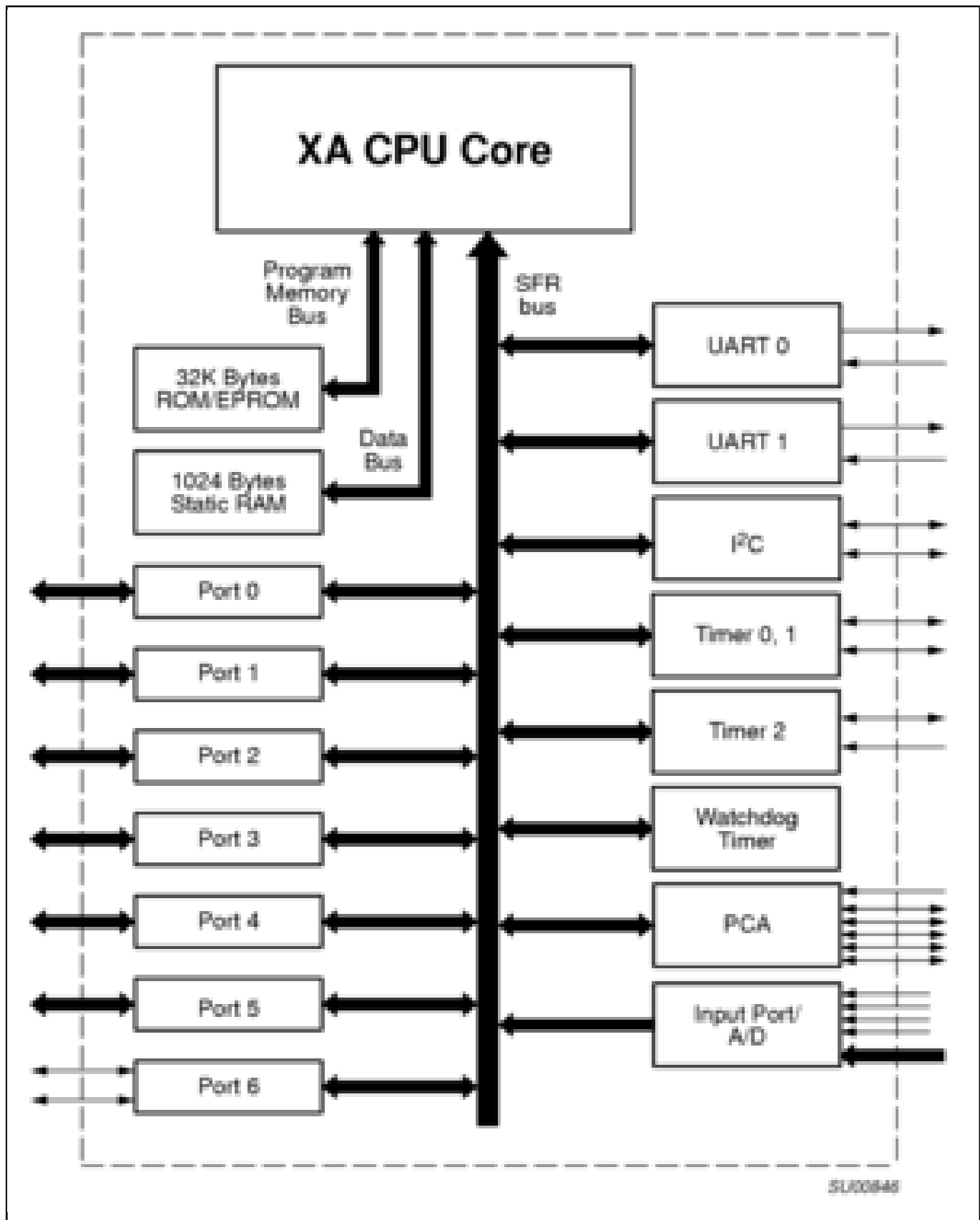

View additional information for [XA 16-Bit Microcontroller Family](#).

Note: The information on this document is subject to change without notice.

www.nxp.com

NXP and the NXP logo are trademarks of NXP B.V. All other product or service names are the property of their respective owners. The related technology may be protected by any or all of patents, copyrights, designs and trade secrets. All rights reserved. © 2024 NXP B.V.