



Refrigerator Compressor

REFRIGERATOR-COMPRESSOR

Last Updated: Nov 8, 2023

The refrigerator compressor solution with brushless DC motor (BLDC) sensorless control offers greater efficiency using field-oriented control (FOC) based on the MC56F82xxx controller.

Brushless DC motors are used more and more often in order to increase the efficiency in reciprocating refrigerator compressors. Because there's nowhere to install sensors in the compressor, the motor has to have a sensorless controller.

Refrigerator Compressor Block Diagram

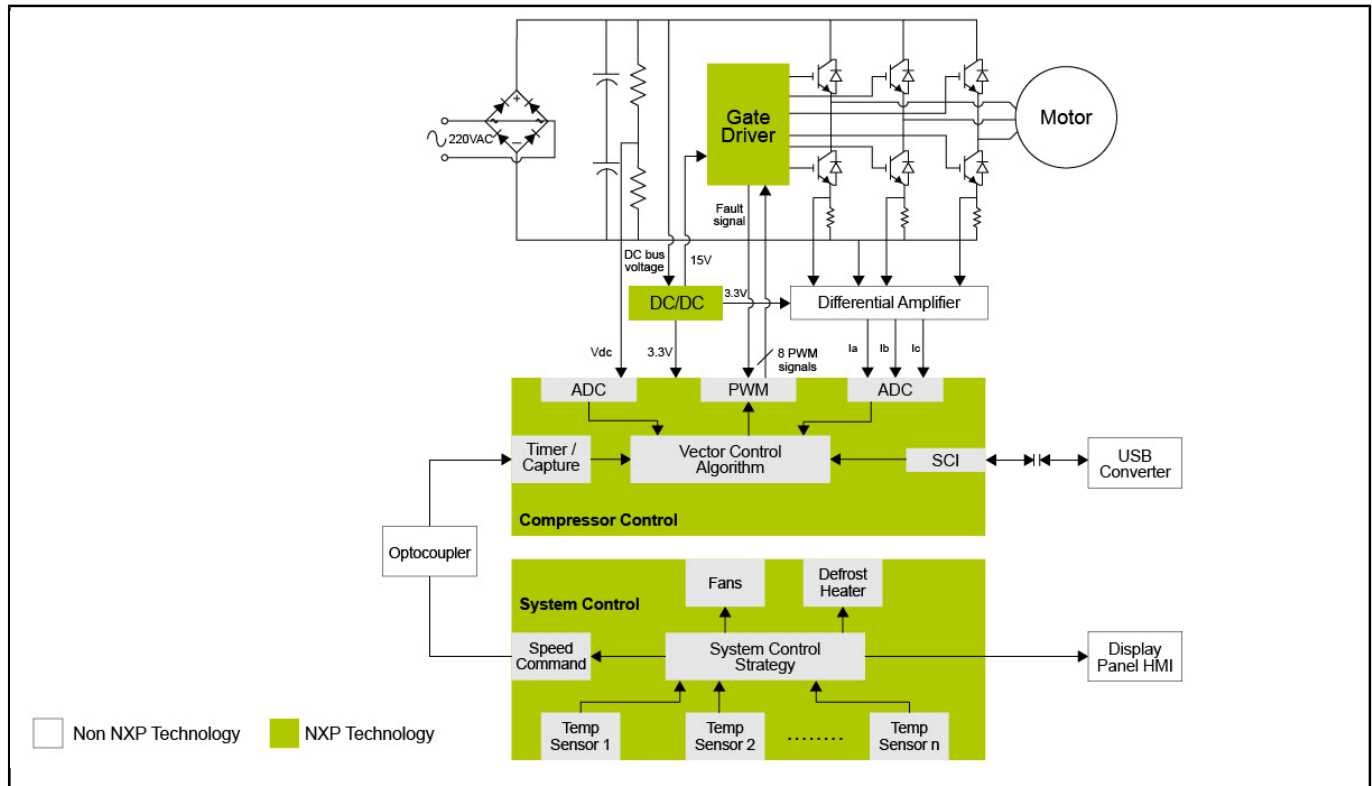

View additional information for [Refrigerator Compressor](#).

Note: The information on this document is subject to change without notice.

www.nxp.com

NXP and the NXP logo are trademarks of NXP B.V. All other product or service names are the property of their respective owners. The related technology may be protected by any or all of patents, copyrights, designs and trade secrets. All rights reserved. © 2023 NXP B.V.