



8-bit Segment LCD LL MCUs

S08LL

Last Updated: Dec 24, 2025

The S08LL 8-bit segment LCD microcontroller family is ideal for battery-powered applications such as medical diagnostics or handheld appliances. The S08LL family extends battery life with comprehensive low-power technology, speeds development time and eliminates excess cost with its complete tower ecosystem.

Test for QC preview?

S08LL Microcontroller Block Diagram Block Diagram

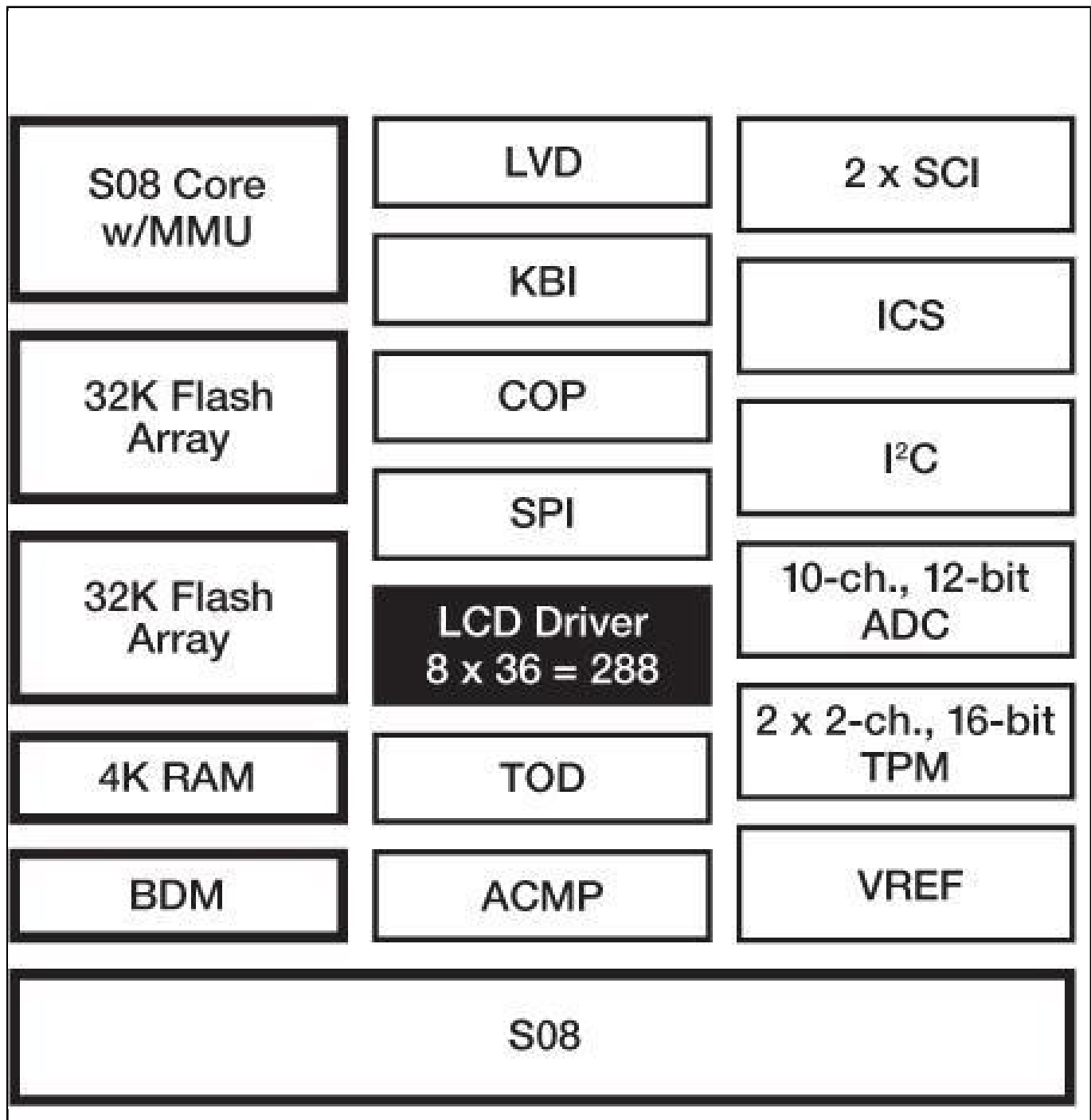

View additional information for [8-bit Segment LCD LL MCUs](#).

Note: The information on this document is subject to change without notice.

www.nxp.com

NXP and the NXP logo are trademarks of NXP B.V. All other product or service names are the property of their respective owners. The related technology may be protected by any or all of patents, copyrights, designs and trade secrets. All rights reserved. © 2026 NXP B.V.