



S12XD Automotive and Industrial Microcontrollers (MCUs)

S12XD

Last Updated: Apr 8, 2022

Targeted for automotive multiplexing and mid-range body applications requiring flash from 64 KB to 512 KB, the MC9S12XD family gives you 32-bit performance (up to 80 MHz) with all the advantages and efficiencies of a 16-bit MCU.

The S12X provides low power consumption, excellent electromagnetic compatibility performance and code-size efficiency advantages.

S12XD Microcontroller Block Diagram Block Diagram

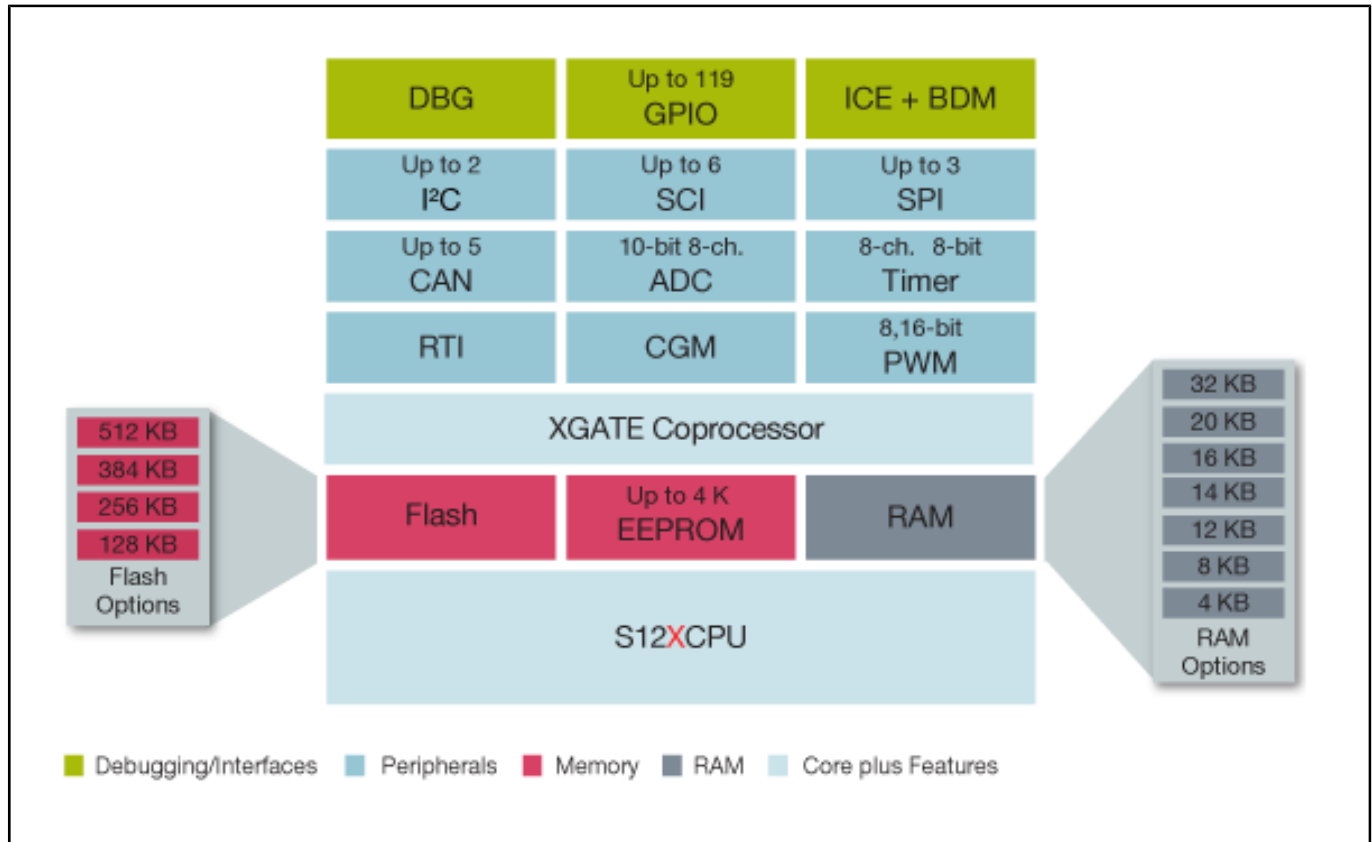

View additional information for [S12XD Automotive and Industrial Microcontrollers \(MCUs\)](#).

Note: The information on this document is subject to change without notice.

www.nxp.com

NXP and the NXP logo are trademarks of NXP B.V. All other product or service names are the property of their respective owners. The related technology may be protected by any or all of patents, copyrights, designs and trade secrets. All rights reserved. © 2022 NXP B.V.