



UCODE® 7xm-1k, 7xm-2k and 7xm+

SL3S1004_1014

Last Updated: Apr 9, 2022

The UCODE 7xm series is the latest generation of NXP's memory UHF tag ICs. With its read range, the UCODE 7xm is suited for applications which require high read range and also demanding an extended user memory to store data specific to customer or products. UCODE 7xm offers an user memory of 1-kbit, whereas UCODE 7xm+ supports 2-kbit user memory and a 384-bit digital signature.

Both products incorporate features known from UCODE 7 like pre-serialization, tag power indicator as well as the product status flag.

There are numbers of applications where the combination of high read range and user memory is needed, such as:

- Inventory and supply chain management
- Process optimization (e.g in the automotive industry)
- Brand protection/authentication (e.g. expensive wines or branded luxury fashion items)
- Automatic vehicle ID where no cryptography is required
- Asset tracking (e.g. for high value assets)

UCODE 7xm Block Diagram Block Diagram

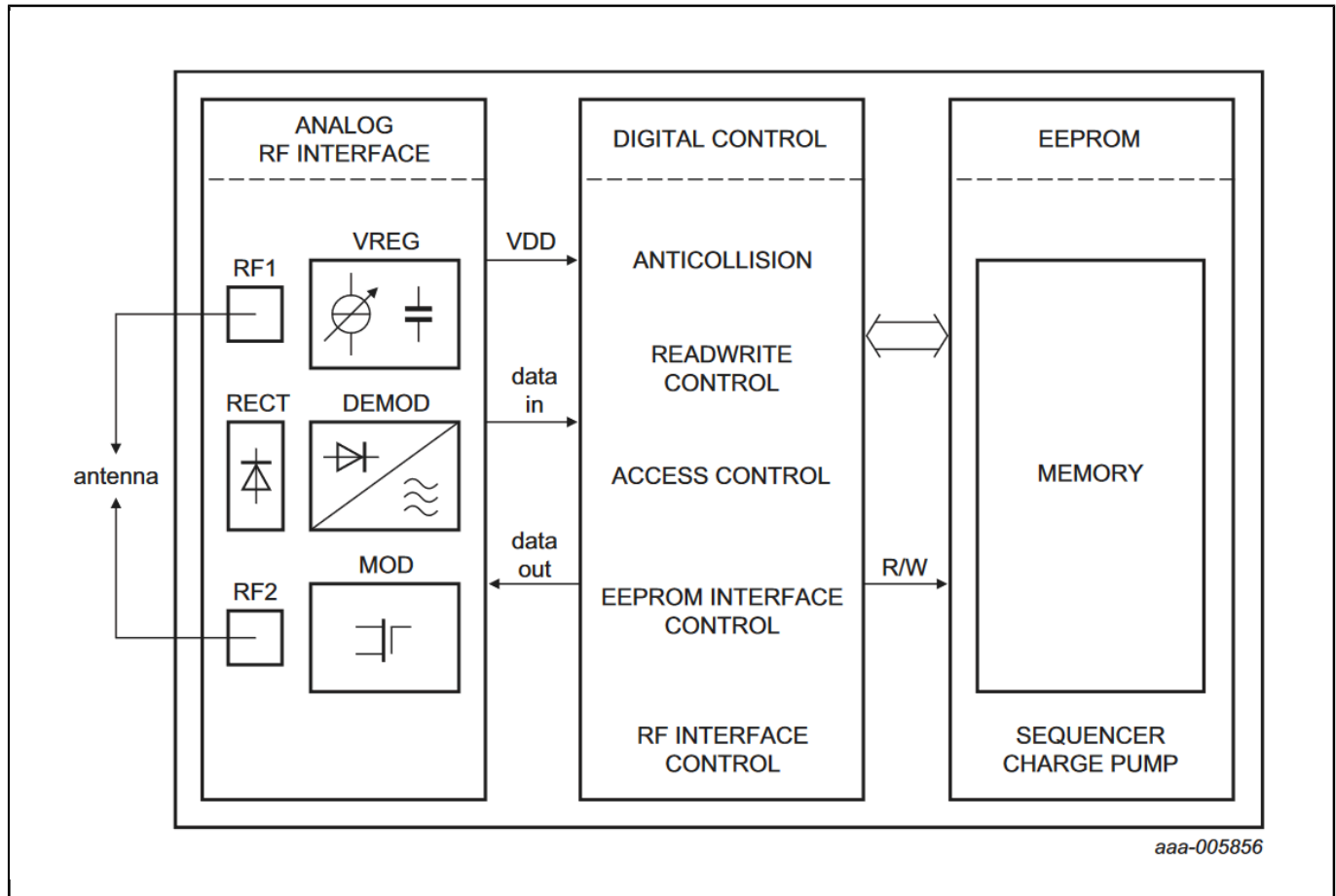

View additional information for [UCODE® 7xm-1k](#), [7xm-2k](#) and [7xm+](#).

Note: The information on this document is subject to change without notice.

www.nxp.com

NXP and the NXP logo are trademarks of NXP B.V. All other product or service names are the property of their respective owners. The related technology may be protected by any or all of patents, copyrights, designs and trade secrets. All rights reserved. © 2022 NXP B.V.