



GreenChip Synchronous Rectifier Controller

TEA1892

Last Updated: Apr 25, 2023

The TEA1892ATS is a member of the new generation of Synchronous Rectifier (SR) controller ICs for switched mode power supplies. Its high level of integration allows the design of a cost-effective power supply with a very low number of external components.

The TEA1892ATS is a controller IC dedicated to synchronous rectification on the secondary side of discontinuous conduction mode and quasi-resonant flyback converters.

The TEA1892ATS is fabricated in a Silicon-On-Insulator (SOI) process.

TEA1892 Block Diagram Block Diagram

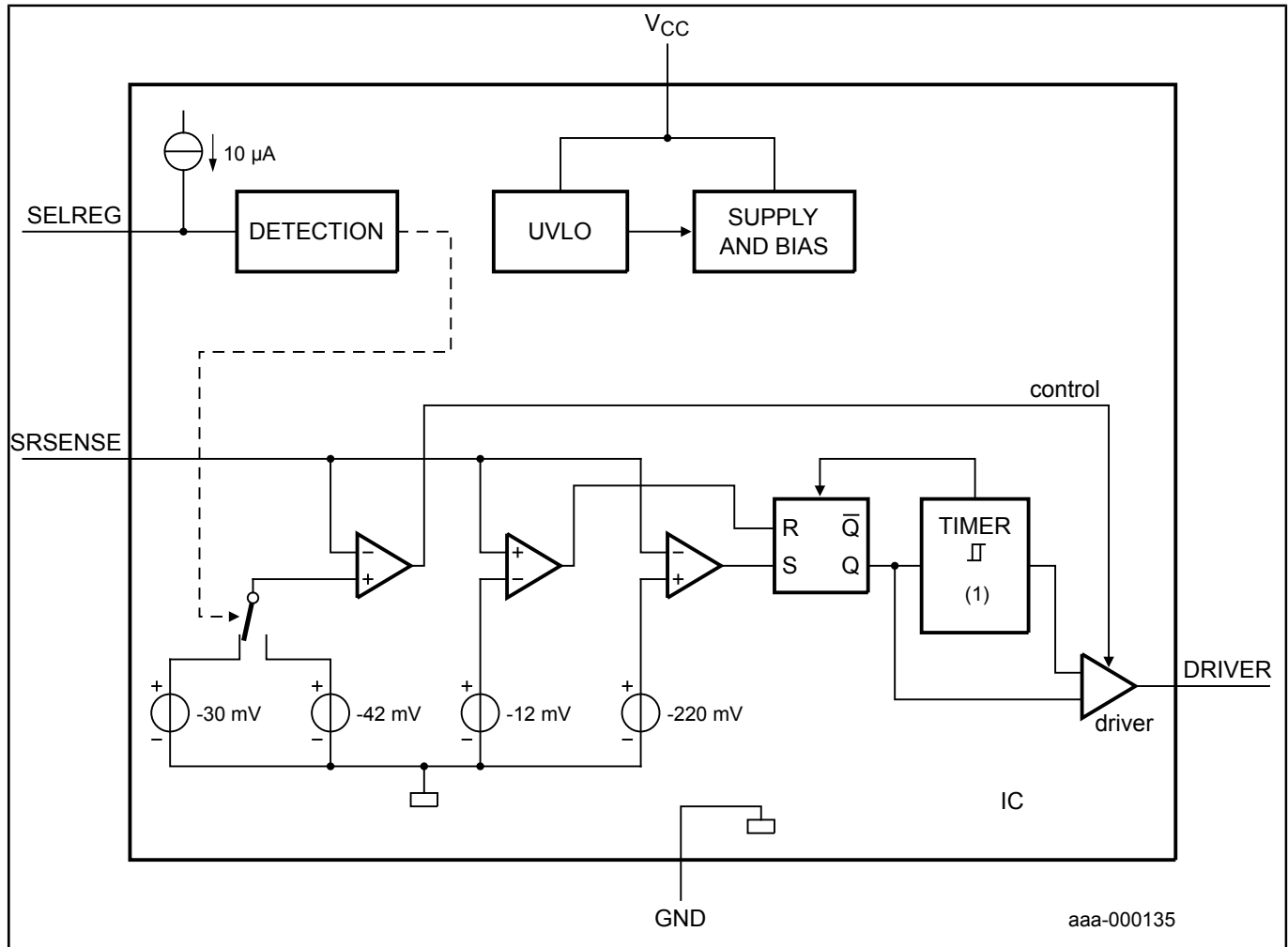

View additional information for [GreenChip Synchronous Rectifier Controller](#).

Note: The information on this document is subject to change without notice.

www.nxp.com

NXP and the NXP logo are trademarks of NXP B.V. All other product or service names are the property of their respective owners. The related technology may be protected by any or all of patents, copyrights, designs and trade secrets. All rights reserved. © 2024 NXP B.V.