

AN10966

UBA2024B CFL ballast up to 120 V (AC) without voltage doubler

Rev. 1 — 13 December 2010

Application note

Document information

Info	Content
Keywords	UBA2024B, CFL, integrated half-bridge driver with integrated switches, lighting
Abstract	Application note for NXP Semiconductors UBA2024B CFL driver running on 100 V (AC) to 120 V (AC) mains without a voltage doubler circuit



Revision history

Rev	Date	Description
v.1	20101213	First issue

1. Introduction

This application note describes the design process of a CFL ballast for mains voltages from 100 V (AC) to 120 V (AC) and should therefore be considered as an addition to *Application note AN10713: 18 W CFL lamp design using UBA2024 application development tool and application examples*; see [Ref. 1](#).

An application development tool is available to simplify lamp design and calculation of the resonance circuit. It can also generate a bill of materials needed to build the application. This application development tool is only available on the CD-Rom that comes with the UBA2024B development box and is optimized for designing UBA2024B applications.

The UBA2024 is a family of integrated half-bridge power IC's designed for use in an integrated/sealed Compact Fluorescent Lamp (CFL) with lamp powers of up to 26 W. Typical input voltages are 100 V (AC) to 127 V (AC) and 220 V (AC) to 240 V (AC). The term lamp is used throughout this publication meaning both burner and electronic ballast.

The UBA2024 includes both half-bridge power transistors with a level-shifter and drivers, bootstrap circuitry, an internal power supply, a precision oscillator and a start-up frequency sweep function for soft start and/or quasi-preheating. Due to the high level of integration, only a few external components are needed in a lamp ballast with the UBA2024.

The UBA2024 family of integrated CFL ballast controller IC's have different $R_{DS(on)}$, package and current ratings; see [Table 1](#).

Table 1. The UBA2024 family

Type number	Package			Parameters	
	Name	Description	Version	$R_{DS(on)}$	I_{SAT}
UBA2024P	DIP8	plastic dual in-line package; 8 leads (300 mil)	SOT97-1	9 Ω	900 mA
UBA2024T	SO14	plastic small outline package; 14 leads; body width 3.9 mm	SOT108-1	9 Ω	900 mA
UBA2024AP	DIP8	plastic dual in-line package; 8 leads (300 mil)	SOT97-1	6 Ω	1350 mA
UBA2024AT	SO14	plastic small outline package; 14 leads; body width 3.9 mm	SOT108-1	6.4 Ω	1200 mA
UBA2024BP	DIP8	plastic dual in-line package; 8 leads (300 mil)	SOT97-1	2 Ω	2500 mA
UBA2024BT	SO14	plastic small outline package; 14 leads; body width 3.9 mm	SOT108-1	2 Ω	2500 mA

Table 2. UBA2024 application range

Type number	Lamp power ^[1] (W)	Mains voltage (AC)	Input configuration
UBA2024P	5 to 14	100 V to 127 V	voltage doubler
UBA2024T		220 V to 240 V	standard
UBA2024AP	15 to 18	100 V to 127 V	voltage doubler
UBA2024AT		220 V to 240 V	standard
UBA2024BP	5 to 26	100 V to 127 V	standard
UBA2024BT			

[1] Overall lamp power including driver circuit.

1.1 UBA2024 family features

- Integrated half-bridge power IC for CFL applications (both power and controller)
- Accurate oscillator with adjustable frequency
- Soft-start by frequency sweep down from start frequency
- Quasi-preheat option (programmable sweep down timing)

1.2 System benefits

- Allows for very compact integrated lamp ballast which fits a small shell
- Low cost CFL applications due to low component count
- Higher reliability due to low component count
- Longer lamp life due to quasi-preheat
- Easily applicable
- Based on EZ-HV Silicon-On-Insulator (SOI) technology
- UBA2024P, UBA2024AP, UBA2024T and UBA2024AT can withstand a maximum voltage of 550 V
- UBA2024BP and UBA2024BT can withstand a maximum voltage of 250 V

1.3 UBA2024B benefits

The half-bridge power transistors of the UBA2024B have a lower R_{on} and allow higher current through the power transistors. However, the breakdown voltage is limited and therefore a UBA2024B cannot be used for mains voltages above 127 V (AC).

To achieve operation with a burner voltage of 80 V (RMS) and above from a 100 V (AC) to 120 V (AC) mains voltage, two topologies are commonly used as shown in [Figure 1](#).

The first possibility is to use a "voltage doubler" circuit, that requires an extra electrolytic capacitor. On top of that the half-bridge switches require a voltage rating equal to that needed for a 230 V (AC) application.

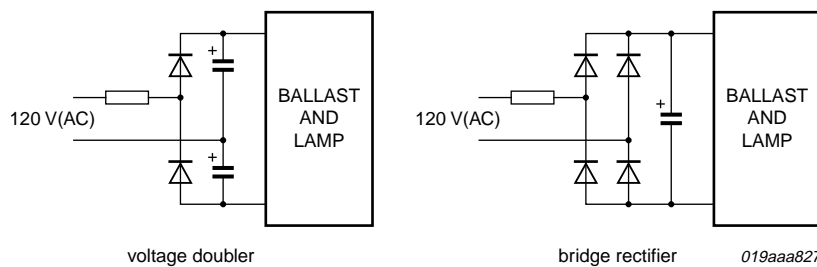

Fig 1. Mains input configurations for 100 V (AC) to 120 V (AC)

Please refer to [Ref. 1 "Application note AN10713"](#) for more information about the voltage doubler topology.

The other possibility to drive burners at voltages above 80 V (RMS) is using resonant gain from the LC-tank without a voltage doubler. This method is described in this application note. The benefits are a lower voltage rating for the half-bridge switches and no requirement for an extra electrolytic capacitor for the voltage doubler.

The reactive current will be higher when using resonant gain from the LC-tank. As this current passes the integrated half-bridge switches in the IC, the half-bridge switches must have a lower R_{on} to limit the power dissipation.

2. Circuit diagrams

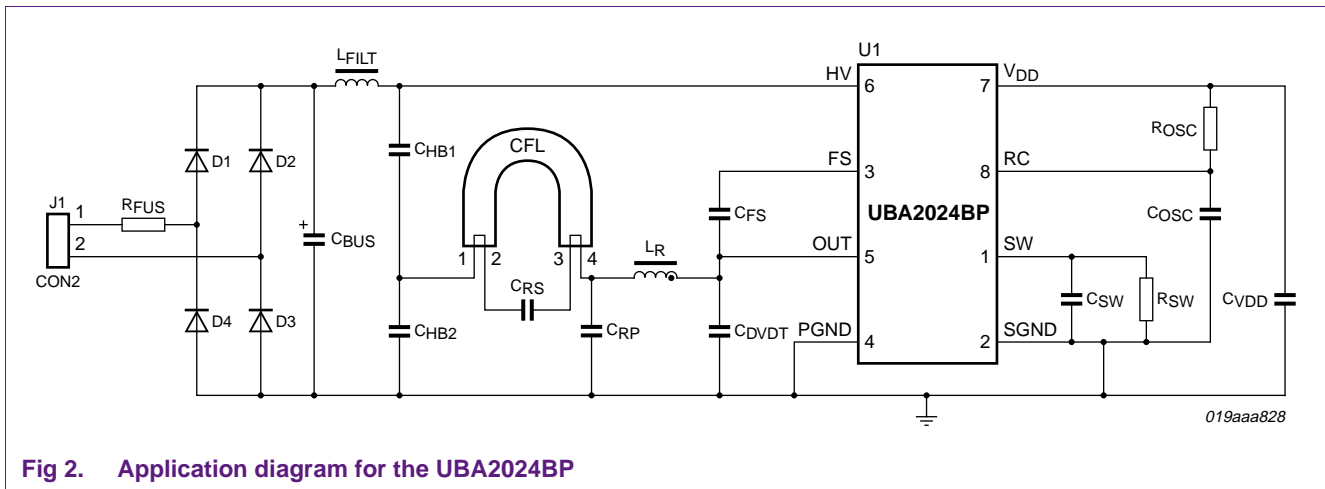

Fig 2. Application diagram for the UBA2024BP

Figure 2 shows the typical circuit diagram of the UBA2024BP in a DIP8 package. Figure 3 shows a version with the UBA2024BT in an SO14 package.

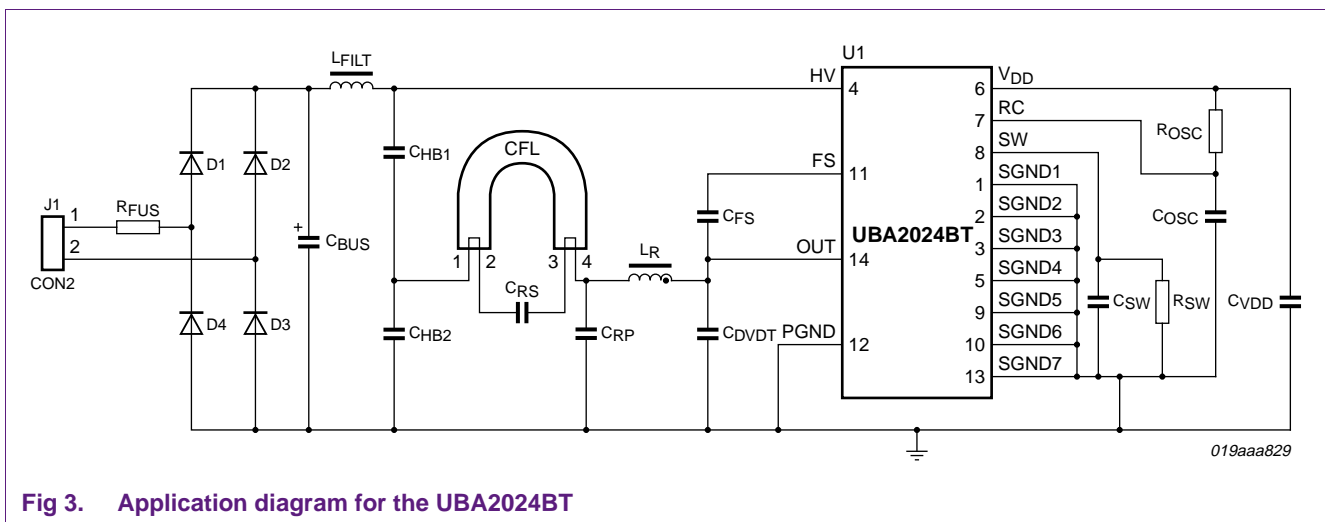

Fig 3. Application diagram for the UBA2024BT

The input circuit of the application comprises a Fusistor (R_{FUS}), a diode rectifier bridge (D1 to D4), and a buffer capacitor (C_{BUS}). L_{FILT} suppresses the harmonic disturbances on the mains supply from the half-bridge switching frequency.

UBA2024B CFL ballast up to 120 V (AC) without voltage doubler

The controller IC is connected to timing components using the via pins RC for the oscillator and SW for the frequency sweep during preheat. The output of the IC drives the dV/dt capacitor C_{DVDT} , the resonant tank and the burner, where C_{HB1} and C_{HB2} are used for DC blocking. See [Ref. 2 "Data sheet UBA2024"](#) for a functional description of the IC.

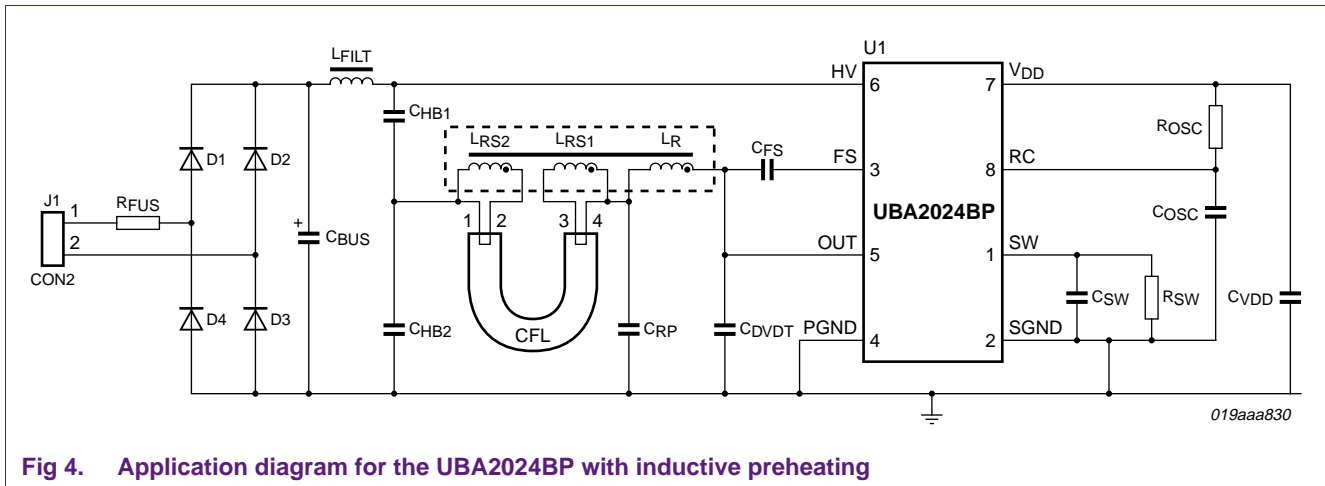

Fig 4. Application diagram for the UBA2024BP with inductive preheating

An example using inductive preheating with a UBA2024BP is shown in [Figure 4](#). In this schematic, only one resonant capacitor C_{RP} is needed. In this case, you can apply the total resonant capacitance here. The design of a circuit with inductive preheat lies beyond the scope of this document.

In [Figure 2](#) and [Figure 3](#) there are two resonant capacitors present, named C_{RP} and C_{RS} . When the filament current (which in these two schematics is equal to the current through capacitor C_{RS}) is higher than the maximum allowed filament current (I_{LL}), the total resonant capacitance can be divided over both C_{RS} and C_{RP} . Part of the I_{LH} (before C_{RP} was present) will now pass through C_{RP} bringing I_{LL} to the required value.

[Figure 5](#) shows the flow of the lamp currents I_{LH} (Lead High), I_D (Discharge) and I_{LL} (Lead Low), where the discharge current is in fact the lamp current. The relationship between these currents is as follows:

$$I_{LH} = \sqrt{I_D^2 + I_{LL}^2} \tag{1}$$

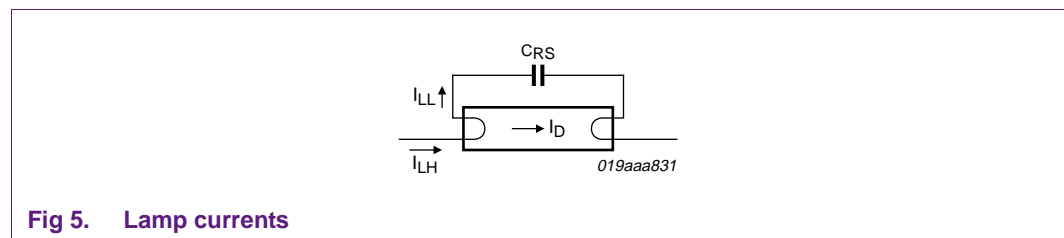

Fig 5. Lamp currents

So the total resonance capacitance is:

$$C_{RES} = C_{RS} + C_{RP} \tag{2}$$

Dividing the resonant capacitance C_{RES} over C_{RS} and C_{RP} results in the specified filament current and avoids decreased lifetime of the burner filaments due to enhanced evaporation of the emissive material of the filaments and severe end-blackening of the tube.

3. Modes of lamp power control

It should be understood that a resonant tank with a self-inductance L , a capacitance C and a burner with an operating voltage V_{lamp} that is driven by a square wave voltage V_{HB} (the half-bridge output) with a given frequency f ($\omega = 2\pi f$) will result in a determined output power P_{out} . This is shown in [Figure 6](#) and [Equation 3](#).

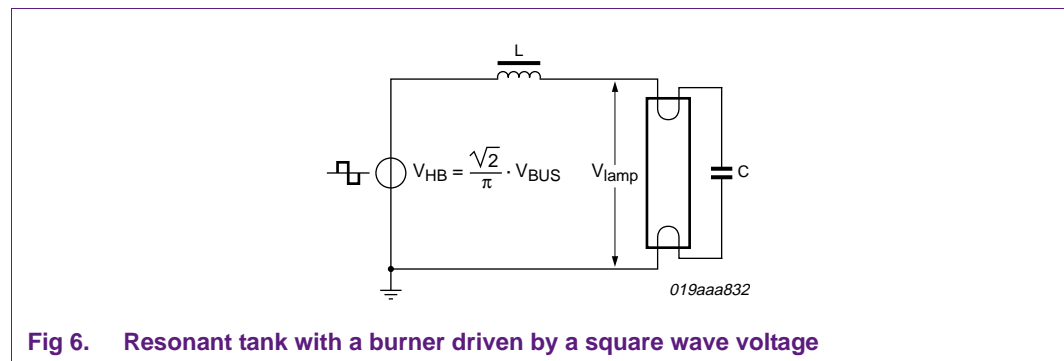

Fig 6. Resonant tank with a burner driven by a square wave voltage

[Equation 3](#) refers to [Figure 6](#).

$$P_{out} = \frac{V_{lamp}^2}{\omega L} \times \sqrt{\left(\frac{V_{BUS}}{V_{lamp}} \times \frac{\sqrt{2}}{\pi}\right)^2 - (1 - \omega^2 LC)^2} = \frac{V_{lamp}}{\omega L} \times \sqrt{\left(\frac{V_{HB}}{V_{lamp}}\right)^2 - (1 - \omega^2 LC)^2} \quad (3)$$

Resonant gain ($Q > 1$) is required when the burner operating voltage is higher than $\sqrt{2}/\pi$ times the average bus voltage. Using resonant gain with a fixed frequency would give a very high dependency of the lamp power on the frequency and other component values. Therefore, the spread in lamp power given normal component tolerances would be too high. An example of a transfer function with resonant gain running on a fixed frequency is shown in [Figure 7](#). The resulting variation in power is also shown for a frequency deviation of $\pm 5\%$ of its nominal value.

The UBA2024B can be used in two modes of operation, fixed frequency and frequency control by feedback. The choice of operating mode depends on the ratio between operation voltage of the burner and the bus voltage (rectified mains). Fixed frequency operation is applied when no resonant gain is required which is the case when:

$$V_{lamp} \leq V_{BUS} \times \sqrt{2}/\pi$$

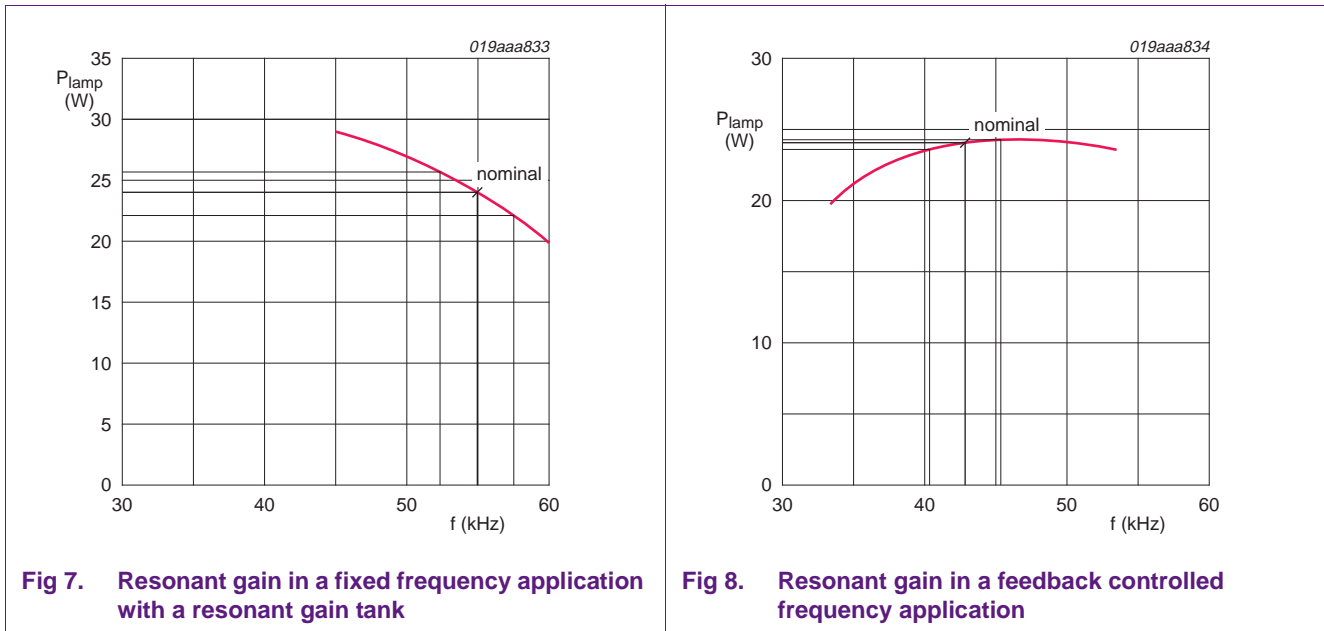

A resonant tank driven close to its resonant frequency will operate in a similar way to a current source. The lamp voltage will have a spread due to temperature, aging and production. Therefore, in the case where a high gain is needed (as the lamp voltage is high), it is desirable to operate the tank close to the resonant frequency as this gives the smallest spread in power. This is shown in [Figure 8](#), where a frequency deviation only leads to small variations in power. Further details about this operating mode can be found in [Section 3.2](#).

3.1 Fixed frequency operation

Fixed frequency operation is well known and proven in the UBA2024(A). The half-bridge switching frequency is determined by R_{OSC} and C_{OSC} in [Equation 4](#):

$$f_{osc,HB} = \frac{1}{k \times R_{OSC} \times C_{OSC}} \tag{4}$$

The oscillator constant k has a typical value of 1.1, see [Ref. 2 "Data sheet UBA2024"](#). The calculation tool calculates the inductor and capacitor values of the LC-tank in such a way that the IC will not run into hard switching at normal operation. In this mode of operation, practical values for R_{OSC} range between 50 kΩ and 400 kΩ. Note that the lower the value of R_{OSC} , the higher the V_{DD} output current is which increases the total package dissipation. Practical values for C_{OSC} range between 100 pF and 1 nF. The recommended value for C_{OSC} is 180 pF for 40 kHz to 50 kHz and 270 pF for 25 kHz to 30 kHz.

The oscillator start frequency is approximately 2.5 times the nominal frequency. It gradually decreases, depending on the lamp type and temperature, until the nominal operating frequency is reached.

The lamp inductor L_R and lamp capacitors ($C_{RS} + C_{RP}$) gradually boost the lamp voltage as the output frequency approaches the resonance frequency until it is sufficient to ignite the lamp. The current in the resonance circuit flows through the filaments providing quasi-preheating. The UBA2024 circuitry stops the frequency sweep at the resonance

frequency f_{res} , if the lamp has not yet ignited (see [Ref. 2 “Data sheet UBA2024”](#) for details). This ensures a maximum effort to ignite the lamp. The resonance frequency depends on L_R and the total capacitance C_{RS} and C_{RP} :

$$f_{res} = \frac{1}{2\pi\sqrt{L_R(C_{RS} + C_{RP})}} \tag{5}$$

As the ignition frequency (f_{ign}) is higher than or equal to the resonance frequency, the resonance frequency should be chosen to ensure the preferred ignition frequency totals:

$$1.6 \times f_{burn} \leq f_{ign} \leq 1.8 \times f_{burn}$$

3.2 Feedback controlled frequency operation

We advise the use of this topology when the burner operating voltage is higher than $\sqrt{2}/\pi$ times the average bus voltage. The resonant tank needs to boost the voltage, therefore the Q factor of the tank must be higher than 1 after the lamp ignites ($Q > 1$). The expression for the output power of the resonant tank is shown in [Equation 6](#):

$$P_{out} = \frac{V_{lamp}^2}{\omega L} \times \sqrt{\left(\frac{V_{BUS}}{V_{lamp}} \times \frac{\sqrt{2}}{\pi}\right)^2 - (1 - \omega^2 LC)^2} \tag{6}$$

where:

$$\omega = 2\pi \times f \tag{7}$$

The aim is to find inductor and capacitor values that generate the required output power and at the same time set the IC to the matching frequency. A transfer function with resonant gain will have a peak at a certain optimum frequency. An example of such a transfer function is shown in [Figure 9](#).

Another goal is to control the operating frequency of the IC so there is zero voltage switching and the ballast is operating at the peak of the transfer function where the calculated lamp power is delivered.

The frequency control is designed to enable the IC to operate close to the peak frequency of the transfer function. This is beneficial because the slope of the transfer function is not very steep at this point.

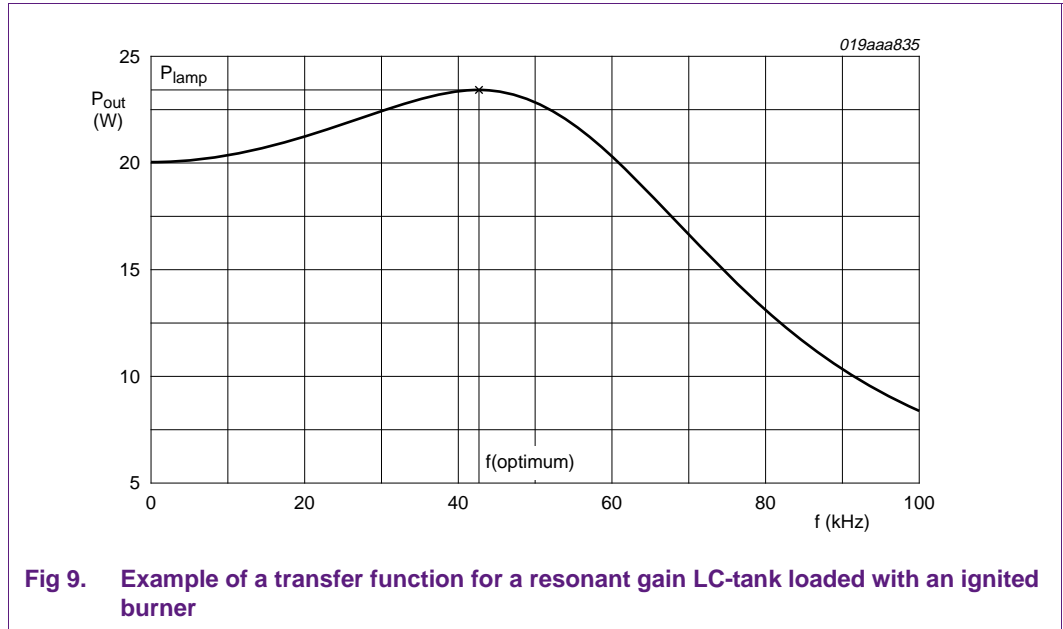

3.2.1 Feedback controlled frequency using C_{DVDT}

When an electronic ballast is running near capacitive mode at Zero Voltage Switching (ZVS), the current through the LC-tank and lamp has a phase angle with respect to the half-bridge voltage that is negative. In other words, the half-bridge voltage lags the coil current. When the LC-tank and the lamp have an inductive character, the opposite is the case and this means that the coil current lags the half-bridge voltage.

Close to the peak of the power transfer characteristic, the phase shift of the coil current compared to the half-bridge voltage will be very low, as shown in Figure 10. We use the coil current with a calculated C_{DVDT} such that the UBA2024B will operate on the edge of hard switching.

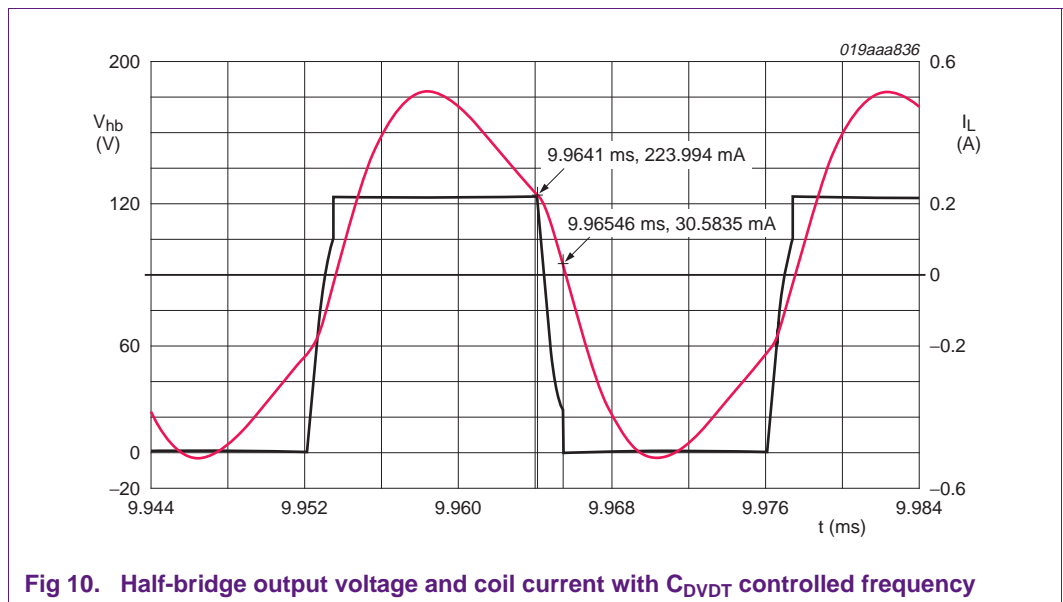

The UBA2024 incorporates a feature originally intended for self-protection during ignition. If the IC enters a hard switching condition, its internal self-protection circuitry will draw charge from the C_{SW} capacitor resulting in an increase in the switching frequency. The frequency increase will reduce the hard switching to below 14 V and as a result the IC will not overheat or be damaged by the switching losses due to charging and discharging C_{DVDT} . This internal self-protection circuitry together with a calculated C_{DVDT} is used as a feedback control loop to control the switching frequency.

Firstly the resonant tank and anticipated operating frequency are determined. In principle, the operating frequency is a user input with an advised value of 40 kHz, but any frequency between 20 kHz and 80 kHz could be given. The NXP Semiconductors tool then calculates the LC tank for a specified operating frequency which is 2 kHz above the peak in the resonant tank transfer function. Given this condition and [Equation 6](#), an optimal resonance capacitance and inductance is found.

It is necessary to ensure that the IC will run on this specified frequency and that it keeps running on this frequency. If this is not a fixed frequency, it will vary a few kHz due to component values and burner voltage (e.g. in case of a cold burner). This feedback control loop is achieved by calculating the capacitance for C_{DVDT} which is needed for a coil current during the dead time after the trailing edge of the half-bridge output voltage that equals:

$$C_{DVDT} = \frac{I_{deadtime} \times t_{deadtime}}{V_{bridge} - I} \quad (8)$$

The value of C_{DVDT} , that provides a frequency 2 kHz above the peak in the resonant tank transfer function, depends on the components in the LC-tank and the properties of the burner.

In the case of frequency control by C_{DVDT} , both coil current and phase determine the frequency. The dead time of the UBA2024B is fixed. A matching C_{DVDT} capacitor value can be calculated using the coil current values at the beginning and the end of the dead time, enabling the UBA2024B to set the frequency to that where the required power is delivered.

When hard switching occurs, there is still a voltage present over the load with a certain polarity at the end of the dead time, as the coil current is still flowing to and from the load. This will lead to extra losses in the half-bridge switches, but as stated earlier a protection feature will prevent excessive hard switching, causing the IC to operate near hard switching. The calculation tool calculates the C_{DVDT} value needed to reach the hard switch level allowed at the required operating frequency.

The C_{DVDT} capacitor is charged and discharged by the inductive load during the dead time. The coil current must not change polarity before the other half-bridge switch is switched on. The half-bridge voltage and coil current can be seen in [Figure 10](#).

3.2.2 Feedback controlled frequency using zero crossing of the coil current

[Figure 11](#) illustrates when the tool returns a value for C_{DVDT} that is relatively small. This is the case when the LC-tank/burner combination already has a capacitive-like character and does not need much additional capacitance to be running on the edge of hard switching at the operation frequency.

The coil current changes polarity during and at the end of the dead time, the half-bridge output is charged to the allowed level of hard switching by the coil current flowing in the opposite direction. The IC will protect itself against this kind of hard switching by increasing the frequency. This is another way of hard switching caused by zero crossing of the coil current during the non-overlap or dead time.

Frequency control at zero crossing of the coil current is also known as Zero Voltage Switching (ZVS), a technique known to be used in discrete Colpitts self-oscillating electronic ballasts.

This is not a preferred method of running on the edge of hard switching. The slopes of the half-bridge voltage are very steep which may cause ElectroMagnetic Interference (EMI). A second disadvantage is that high current flows through the body diodes of the half-bridge switches which is disadvantageous for the efficiency. C_{DVDT} could be increased to achieve frequency control by C_{DVDT} (waveform shown in [Figure 11](#)).

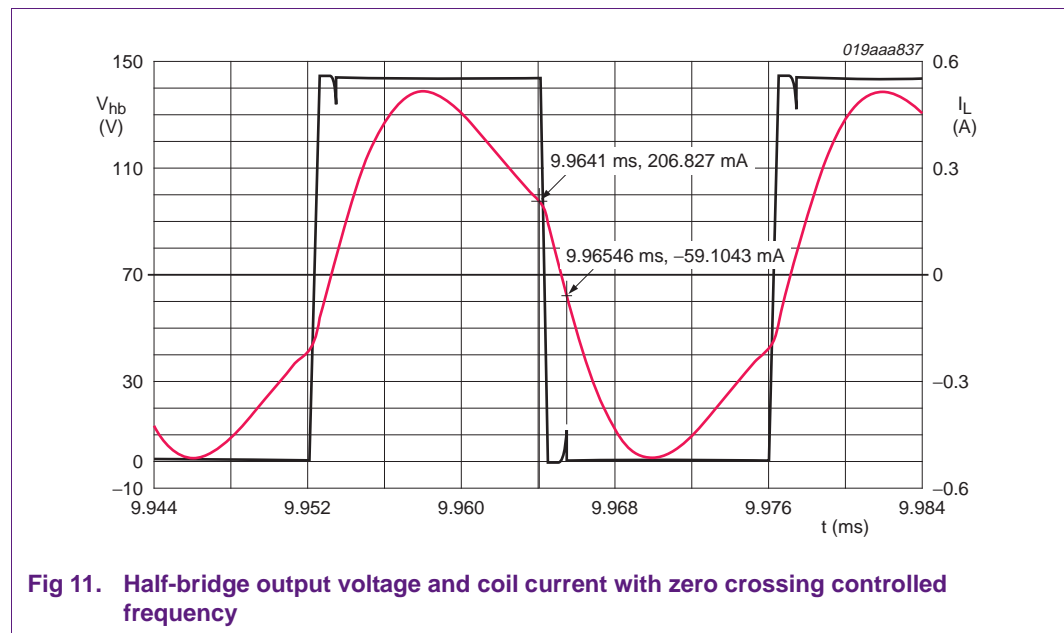

Fig 11. Half-bridge output voltage and coil current with zero crossing controlled frequency

3.2.3 Losses due to hard switching

When the IC is working in feedback controlled frequency operation, it will operate on the edge of hard switching which will lead to additional losses. Hard switching will not occur all the time but as a function of the bus voltage ripple.

This is indicated in [Figure 12](#).

The C_{SW} capacitor is charged when the IC is not hard switching and discharged during hard switching. The feedback system will then balance itself. As a result the hard switching will only occur for approximately 25 % of the time. The hard switching voltage has a maximum level of 14 V and the average power losses due to hard switching can be calculated using [Equation 9](#):

$$P_{hsw} = \frac{t_{hsw}}{T_{V_{BUS}}} \times f_{burn} \times C_{DVDT} \times V_{hsw}^2 \tag{9}$$

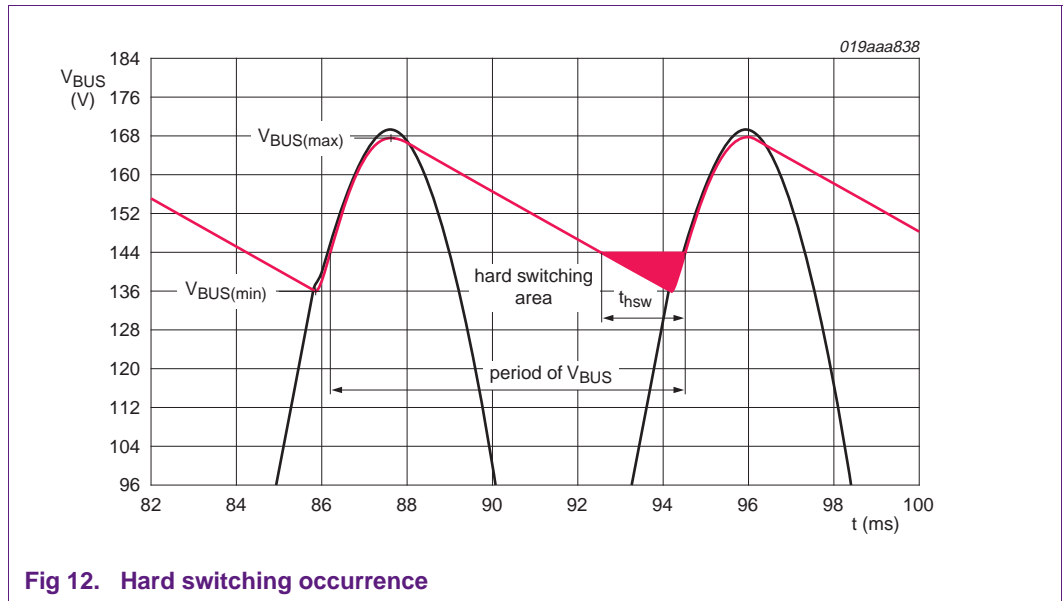

Fig 12. Hard switching occurrence

4. Preheating

In this section the preheat methodologies are explained for both a feedback controlled frequency application and a fixed frequency application. The starting frequency is set for both topologies and consequently the time needed to reach ignition frequency. The circuitry connected to pin SW has therefore changed compared to the default fixed frequency application as shown in *Data sheet UBA2024*. The new schematic is shown in [Figure 13](#).

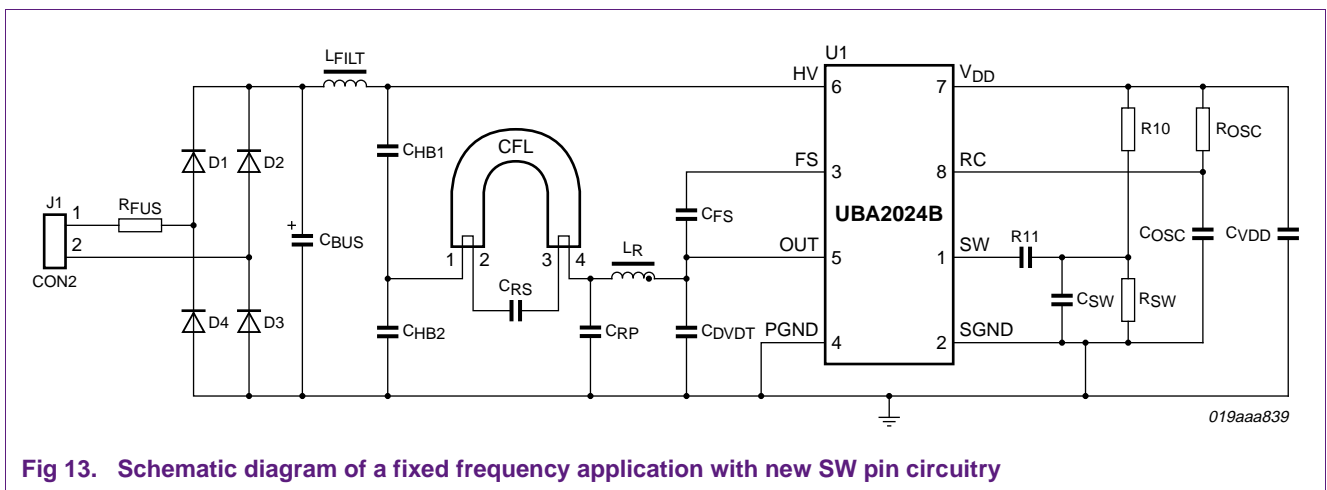

Fig 13. Schematic diagram of a fixed frequency application with new SW pin circuitry

Remark: In the applications as shown in [Figure 2](#) and [Figure 3](#) note that R_{10} is not mounted and that capacitor "R11" is replaced by a 0Ω resistor.

A controlled preheat current where the current would appear as shown in [Figure 14](#) is not possible. There is no free pin available and a sense resistor would lead to additional power losses.

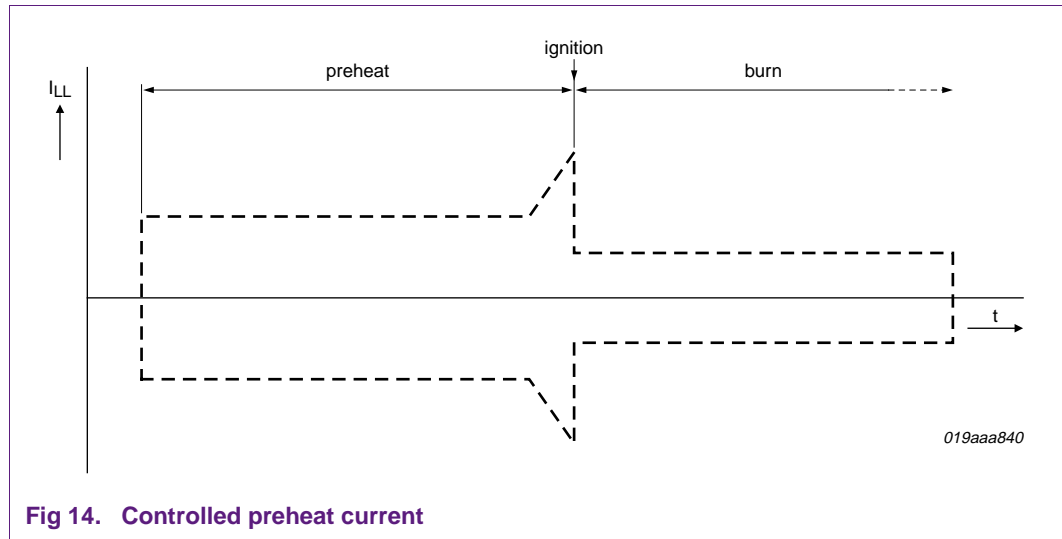

Fig 14. Controlled preheat current

[Section 4.1](#) and [Section 4.2](#) describe how a controlled preheat can be approximated for both a feedback controlled frequency application and a fixed frequency application. Proof of concept is shown in [Section 11.2](#) that these approximations of a controlled preheat are adequate solutions to prevent lamp glow.

If filament specifications are unknown, a rule of thumb is that the optimal ratio between the filament resistance at ignition and cold filament resistance is approximately 5 : 1. With a preheat time between 500 ms and 600 ms this ratio can be reached. With a cold start not only is the ignition voltage is higher but also the starting voltage. Both ignition and starting cause more damage in the case of a cold start.

4.1 Start-up of a feedback controlled frequency application

Since the operating frequency is determined by operation on the edge of hard switching as explained in [Section 3.2](#), the start-up behavior of the application has been optimized for this mode of operation. The circuit that connects to pin SW is different to the default circuit as shown in *Data sheet UBA2024*.

The timing components R_{OSC} and C_{OSC} are chosen in such a way that the oscillator starts at a required preheat frequency, typically approximately 10 kHz above the ignition frequency.

It is now possible to set the starting frequency and consequently, the time needed to reach the ignition frequency by choosing the right values for the timing components R_{OSC} and C_{OSC} . This method allows the designer to program both the preheat frequency and time. A major advantage of this method, compared to a discrete solution using a PTC resistor, is that the same preheat energy is applied as with the discrete solution but without using an expensive PTC. In addition, a PTC resistor has to dissipate power to remain tripped during operation. Using a preheat time of at least 400 ms increases the switch cycle life time of the application and reduces the need for the saturation current through the coil as the ignition voltage decreases. The calculation tool will calculate R_{OSC} for a given C_{OSC} and a default preheat time of 600 ms and will return the actual preheat time. If another preheat time is required, the user can change R_{OSC} and immediately see the effect on the calculated preheat time.

In principle, the minimum frequency is determined by the zero voltage feedback control loop, but to avoid problems (with e.g. a cold burner) a safeguard frequency is introduced by adding a resistor in parallel with C_{SW} , see [Figure 15](#). This extra resistor R_{SW} will determine the minimum frequency of the oscillator.

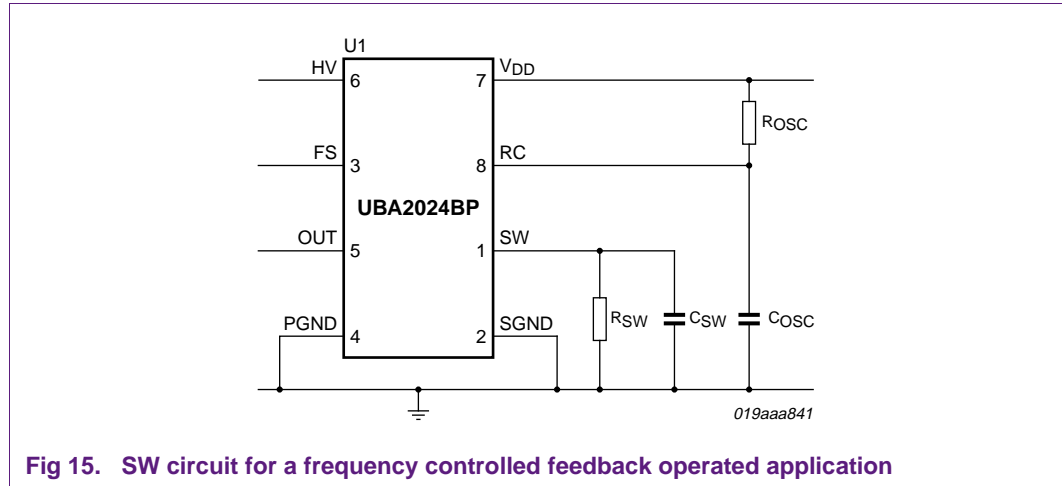
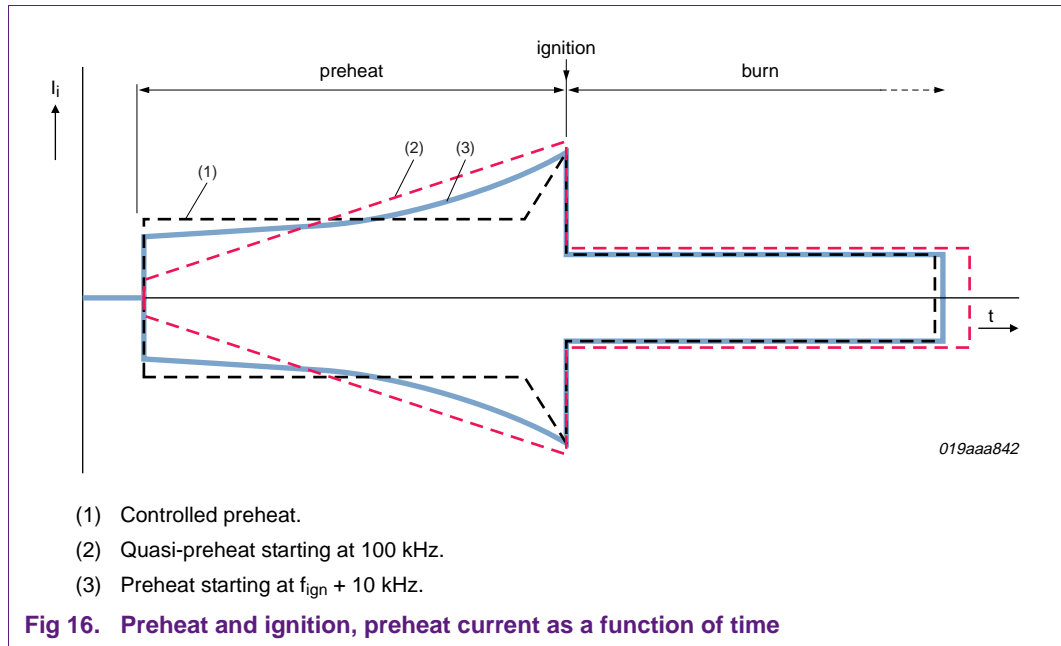

Fig 15. SW circuit for a frequency controlled feedback operated application

The voltage on the SW pin determines the amplitude and as a consequence, the frequency on the RC pin. Resistor R_{SW} will limit the voltage on the SW pin because C_{SW} will be charged with a current of 280 nA. At a level of $280 \text{ nA} \times 4.7 \text{ M}\Omega = 1.32 \text{ V}$, C_{SW} will no longer be charged and the frequency will no longer increase. The time needed to reach this voltage is determined by C_{SW} .

Default values for resistor R_{SW} and capacitor C_{SW} used in the calculation tool for a preheat time of 600 ms are 4.7 M Ω and 470 nF, respectively.

With fixed frequency operation applying the standard application from the datasheet, where the operating frequency is determined by the values of resistor R_{OSC} and capacitor C_{OSC} , the preheat frequency starts at 2.5 times the operating frequency. The preheat current as a function of time will look similar to curve (2) in [Figure 16](#), referred to as Quasi-preheat, starting at 100 kHz. However, in the frequency controlled feedback operation where resistor R_{OSC} and capacitor C_{OSC} only determine the starting frequency of the IC and C_{DVDT} determines the operating frequency, the preheat current will look similar to curve (3) in [Figure 16](#). The advantage of the latter is that more energy is put into the filaments during the quasi-preheat which results in a more predictable ignition and an increased filament lifetime.



In [Figure 16](#) curve (1) represents the preheat current from a system with controlled preheat (see [Figure 14](#)), where the frequency is constant during preheat and decreases to accomplish ignition after the preheat time has passed. Note that preheating at a frequency of approximately 10 kHz above the ignition frequency results in a good approximation of controlled preheat system, e.g. UBA2028.

The recommended value for C_{OSC} for frequency controlled feedback operation is 1200 pF. Lower values of C_{OSC} slightly decrease the duty cycle of the half-bridge output and lead to higher hard switching losses on the leading edge of the half-bridge output voltage. Smaller values for C_{OSC} can be used for fixed frequency operation; see [Section 4.2](#).

4.2 Start-up of a fixed frequency application

The time needed to sweep down (set by C_{SW} only as R_{SW} is not present when the IC is used in the standard application shown in the datasheet) from the start frequency to the resonance frequency can be used as an approximation for the ignition time. The sweep time is typically $C_{SW} \text{ (nF)} \times 10.3 \text{ ms}$. The ignition time is shorter for large values because the lamp ignites before the resonance frequency is reached. The typical ignition time is 1 s when $C_{SW} = 330 \text{ nF}$. A larger C_{SW} increases the sweep time and improves the preheating of the electrodes. However, the rise of the pre-ignition lamp ignition voltage is also slower. Both a quasi-preheat that is too short and a voltage rise that is too slow increase the glow time of the lamp. This reduces the lifetime of the lamp. During the glow phase the lamp is ignited, but the filaments and the gas inside the lamp are not at their final operating temperature. The UBA2024 has a mechanism to push extra energy into the lamp during this glow phase, which is described in the UBA2024 datasheet. This will make the lamp reach its final light output quicker which gives a longer lamp lifetime. Typical values for C_{SW} are between 33 nF and 330 nF when the IC is used in the standard fixed frequency operation mode.

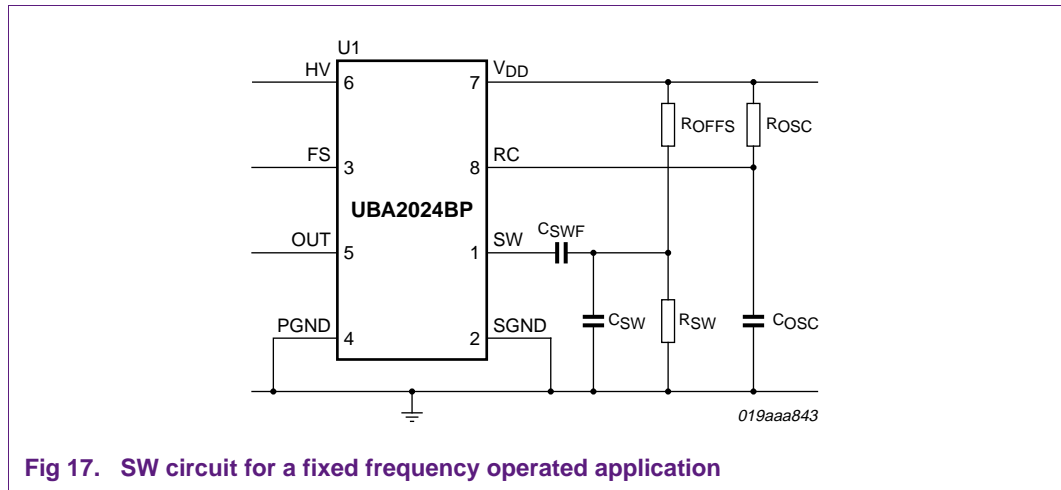

Fig 17. SW circuit for a fixed frequency operated application

In [Figure 17](#) a schematic diagram of the SW circuitry is shown which also provides a starting frequency of approximately 10 kHz above the ignition frequency. In this operation the operating frequency is still determined by R_{OSC} and C_{OSC} according to [Equation 5](#). The starting frequency is determined by the offset voltage that is determined by the voltage divider R_{OFFS} and R_{SW} . The capacitor C_{SW} now works as a filter for this offset voltage. After start up C_{SWF} will be charged further until the IC has reached the operating frequency. This preheating method is similar to the solid blue curve shown in [Figure 16](#).

The default component values used in the calculation tool are $C_{SWF} = 470$ nF, $C_{SW} = 10$ nF, $R_{SW} = 10$ k Ω and $C_{OSC} = 220$ pF. These defaults are used by the calculation tool to determine E48 values for both R_{OFFS} and R_{OSC} , resulting in a preheat time of 600 ms. Finally the tool will also return the actual preheat time using the calculated R_{OFFS} and R_{OSC} .

5. Design of a 26 W non-dimmable CFL

This section explains the selection criteria for the component values. It also clarifies how to enter the appropriate component values into the application development tool. With the calculation tool and the help of some practical guidelines it should be easy to set-up designs of different lamp powers. Throughout this document the light source itself is referred to as the burner. The tool is intended for all use cases of burners operating at 50 V to 130 V; 8 W to 24 W. In this application note, a PL-C 4P, 26 W burner with a specified power of 24 W operating at 80 V is taken as an example.

5.1 Selecting a buffer capacitor and fusistor

Lamp power of a resonant tank with burner always depends on the bus voltage. When using 220 V (AC) or 110 V (AC) with a voltage doubler, this relation is more relaxed than for rectified 110 V (AC).

A bus voltage ripple ratio of between 15 % and 20 % determined by the buffer capacitor is recommended for proper operation. If the buffer capacitor has a value resulting in a ripple ratio of less than 15 %, the application will draw higher than necessary charge current peaks from the mains which reduces the power factor. In the tool, this ratio is calculated and returned to the user. Choosing a smaller buffer capacitor will lead to a higher ripple and a lower average bus voltage.

As a result of this, the LC-tank may have to provide more resonant gain which requires larger resonant capacitors. So choosing a smaller buffer capacitor does not necessarily lead to a smaller application. In addition, the Crest factor of the lamp power would become worse. The following table shows recommended values for the buffer capacitor and fusistor for a standard input configuration as shown in [Figure 1](#) per power range of the application running on a mains voltage of 120 V (AC) and 60 Hz.

Table 3. Advised values for the standard input configuration

Lamp power range ^[1]	C _{BUS}	R _{FUS} ^[2]
4 W	10 μF; 200 V	18 Ω (0.5 W)
5 W to 6 W	15 μF; 200 V	12 Ω (0.5 W)
7 W to 8 W	15 μF; 200 V	12 Ω (1 W)
9 W to 11 W	22 μF; 200 V	5.6 Ω (1 W)
12 W to 14 W	22 μF; 200 V	5.6 Ω (2 W)
15 W to 18 W	22 μF; 200 V	5.6 Ω (2 W)
19 W to 22 W	33 μF; 200 V	3.3 Ω (2 W)
23 W to 26 W	33 μF; 200 V	3.3 Ω (2 W)

[1] Overall lamp power including driver circuit.

[2] Minimum continuous power rating.

5.2 Using the calculation tool

This section describes how to use the calculation tool and how to interpret the results.

5.2.1 Input values

The application development tool calculates the component values based on the following input parameters:

- Burner power
- Burner operating voltage
- Burner ignition voltage
- Filament resistance
- Maximum filament current
- Mains input voltage and frequency (typical operating voltage)
- Combined value of the DC blocking capacitors

[Figure 18](#) shows the part of the application development tool where the input parameters can be entered. The example shows the design of a 26 W lamp. This is the total lamp power, which means 24 W burner power and about 2 W loss in the electronic ballast. The burner used in this example is a replaceable burner. It is based on a G24q-3 fitting with the following parameters.

- Burner power = 24 W
- Burner voltage = 80 V
- Ignition voltage = 460 V
- Warm filament resistance = 9 Ω
- Maximum filament current = 320 A

The following actions need to be taken:

1. Enter the burner parameters
2. Enter the mains voltage to be used for the 26 W lamp (120 V)
3. Enter the value of the buffer capacitor (33 μ F)
4. Enter the mains frequency (60 Hz)
5. Enter the total value of the blocking capacitors (300 nF)
6. Enter the required operating frequency (40 kHz)

When using burners with an operating voltage up to 73 V, the resonant tank does not have to provide resonant gain. When the UBA2024B is used with burners that have a high operating voltage, the resonant tank provides resonant gain and the frequency is regulated on the edge of hard switching. This frequency regulation is a protection feature of the UBA2024, intended for self-protection during ignition. The advantage of resonant gain is that no voltage doubler capacitors are needed which consume a lot of space in a retrofit CFL. The frequency at which the UBA2024B will run no longer depends on its RC timing components provided f_{min} is selected about 5 kHz below the operating frequency. This will increase the accuracy of the system. The disadvantage of switching on the edge of hard switching is that there are small switching losses in the half-bridge. The additional switching losses amount to less than 15 mW for this application.

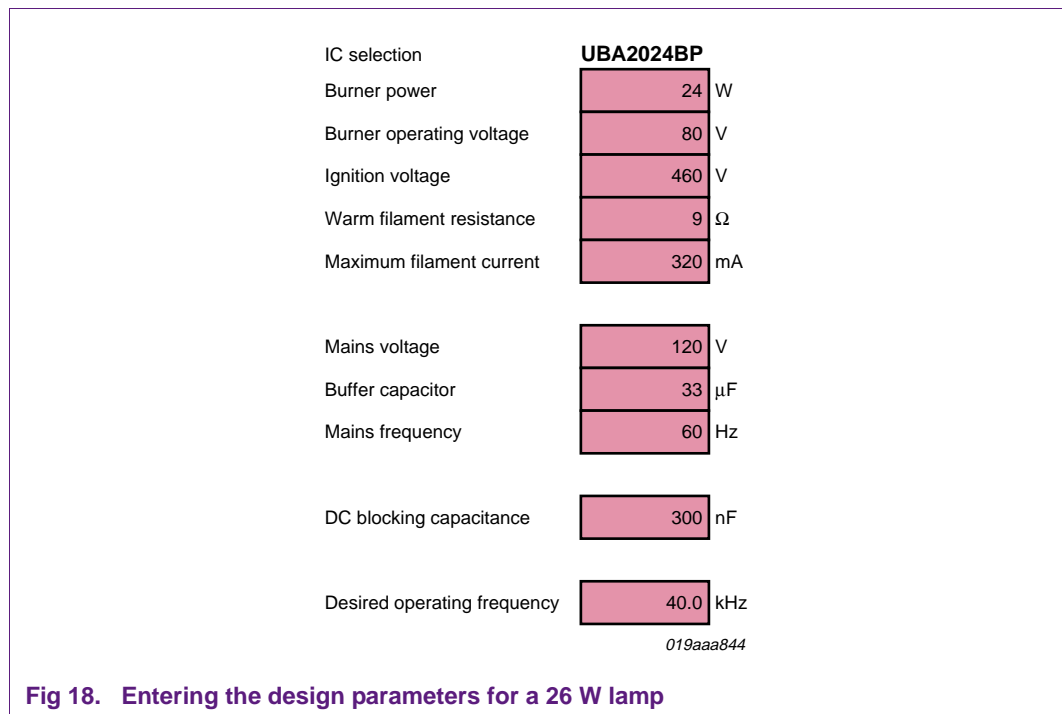

Based on the burner parameters, mains voltage and frequency, the buffer capacitor, selected DC blocking capacitors and the operating frequency required, the calculation of the LC resonance tank can be executed by pressing the Optimize! button (Figure 23). The application development tool then calculates recommended values for the resonance inductor, capacitor and the dV/dt capacitor. The operating frequency is also calculated.

5.3 Calculation algorithm

After entering all the necessary parameters, the calculation will proceed by returning recommended values for the resonance capacitor and inductor. If the calculated filament current is higher than the entered maximum value, the resonance capacitor will be split so that the requirement for the filament current is met. The required capacitance will be instantaneously returned as E12 values.

The next step in the calculation is to achieve a zero voltage switching condition by determining the average coil current during the non-overlap time. The target is to have no difference between the actual average coil current during the non-overlap time and coil current during the non-overlap time. A value is now determined for the dV/dt capacitor that meets these requirements. This capacitance value will also be returned as an E12 value.

Then fine tune to the zero voltage switching condition after the dV/dt capacitor value has been adapted to an E12 value. Again, the target is to have no difference between the actual average coil current during the non-overlap time and the required coil current during the non-overlap time. This is achieved by changing the actual operating frequency f_{burn} and the resonance inductor L_{res} , under the following constraints:

- Average lamp power equals the required burner power
- Actual operating frequency is less than or equal to the tank's resonant peak frequency increased with 2 kHz when the lamp is ignited

The final step is to enter values for the RC timing components R_{OSC} and C_{OSC} . A value higher than 1 nF is recommended for C_{OSC} (default is 1.2 nF), and a R_{OSC} value is advised to set the preheat time to 600 ms. Enter a realistic value that approximates the advised value and the tool will calculate the preheat time instantaneously.

5.4 Calculation results

Once the calculation is complete the tool will display graphs of the average burner power as a function of the rectified bridge voltage (see [Figure 19](#)), burner power as a function of frequency (see [Figure 20](#)) and burner voltage, filament current and frequency as a function of time during start-up (preheat and ignition) (see [Figure 21](#)) of the application.

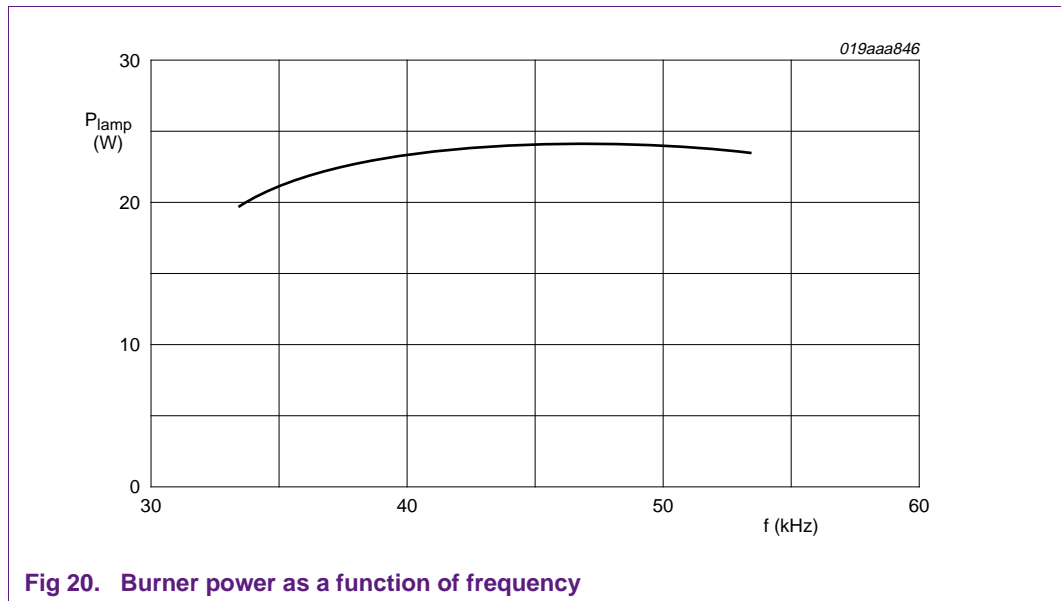
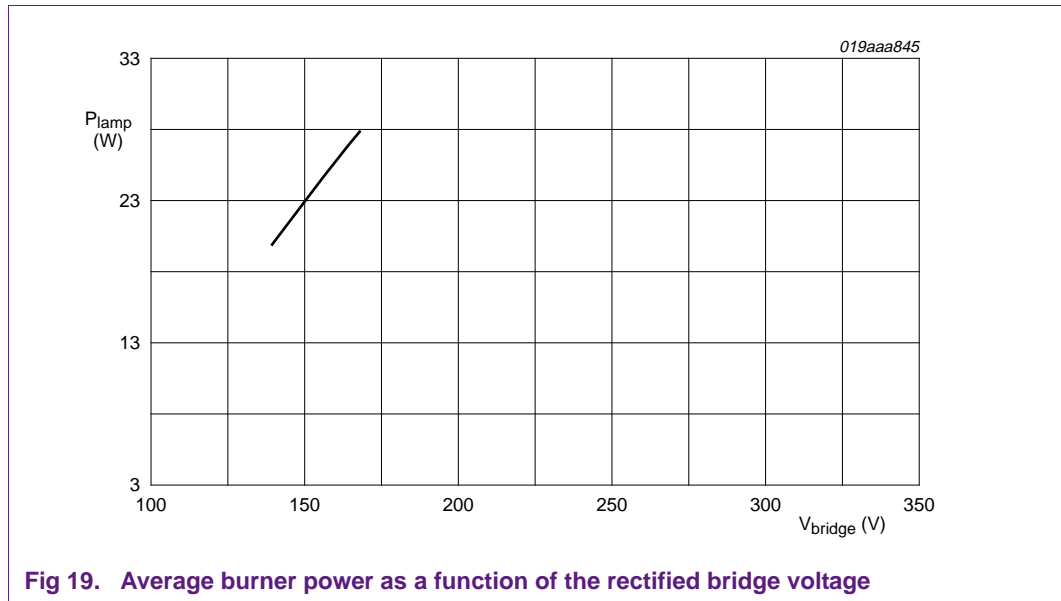

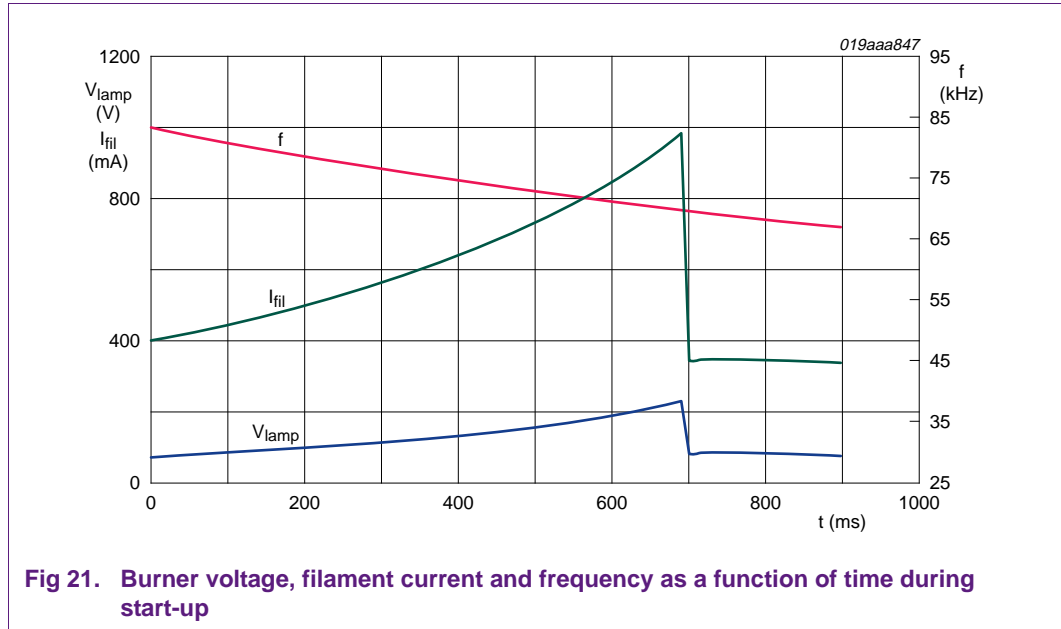

Fig 21. Burner voltage, filament current and frequency as a function of time during start-up

The tool will also display a graph of the calculated lamp power at $f_{burn} \pm 3$ kHz, which will immediately warn the user if the solution is on a steep slope of the power transfer curve of the resonant tank. This graph is shown in [Figure 22](#).

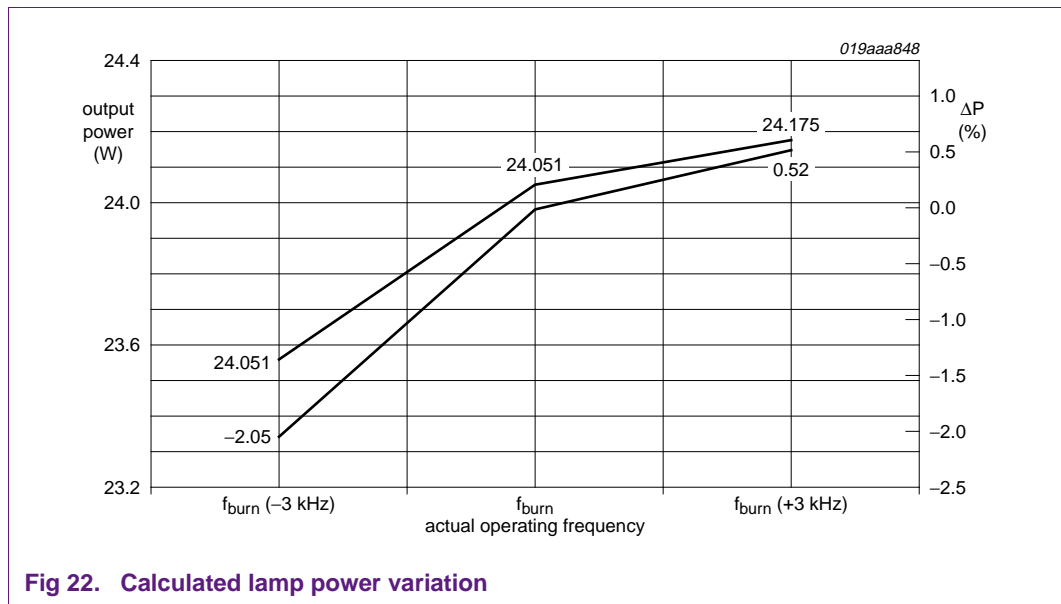

Fig 22. Calculated lamp power variation

The power variation is shown in both W and as a percentage relative to the power at f_{burn} . The numerical output of the tool is shown in [Figure 23 "Input/output data fields"](#).

UBA2024B CFL ballast up to 120 V (AC) without voltage doubler

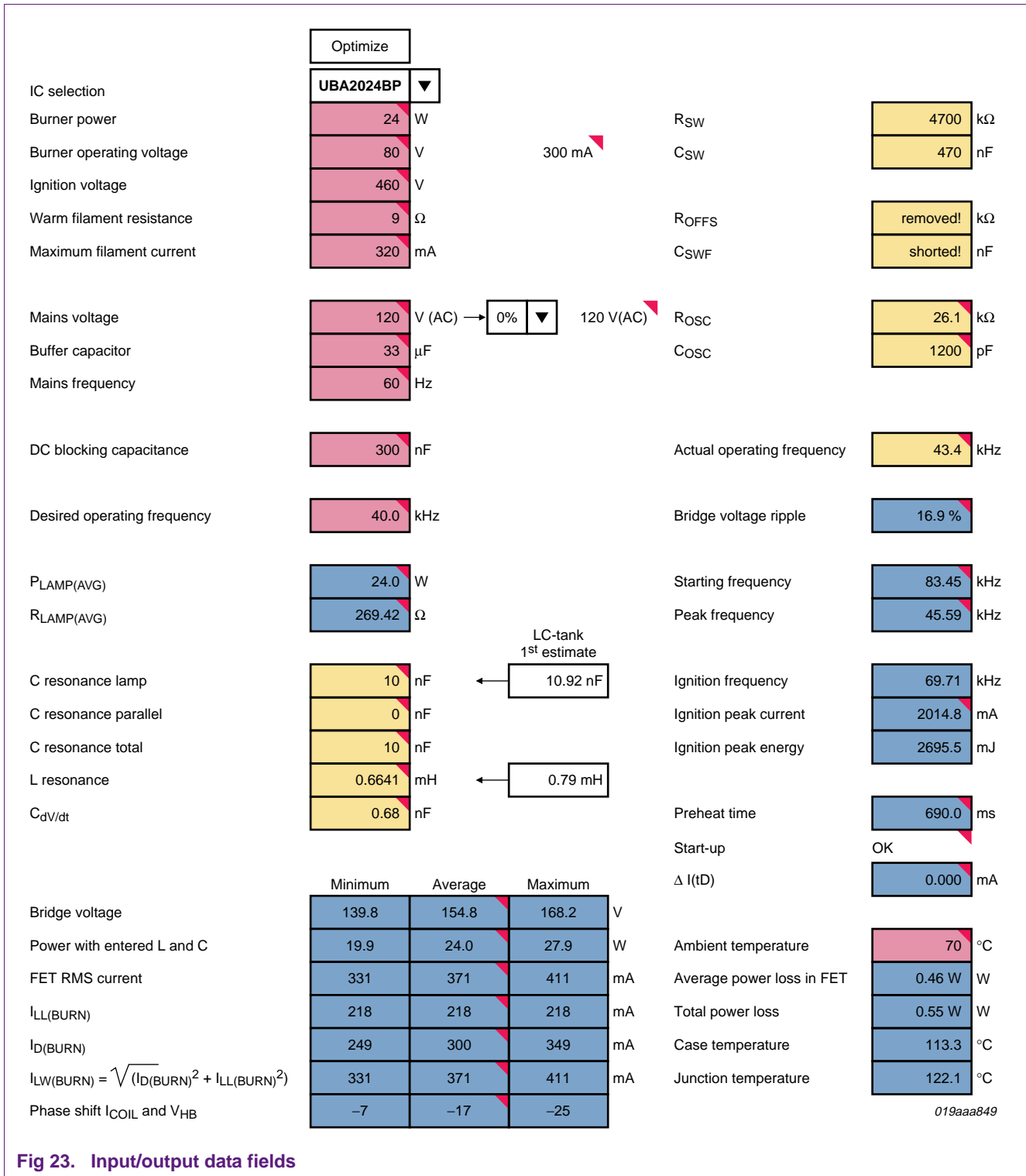

Fig 23. Input/output data fields

Calculation results are listed along with the entered burner properties, mains voltage and the required operating frequency which comprise of:

- Component values of the resonant tank (C_{RS}, C_{RP}, L_R and C_{DVDT})
- Actual operating frequency

- Average lamp power and resistance
- Various frequencies (f_{start} , $f_{ignition}$, f_{min} , f_{PEAK})
- The preheat time (t_{ph})
- Start-up condition
- Coil current balance during the non-overlap time ($\Delta I_{(tD)}$)
- The advised resonant tank components which are calculated at the beginning of the algorithm ($C_{R(ADV)}$ (total capacitance of $C_{RS} + C_{RP}$ not rounded to E12 values) and $L_{R(ADV)}$)
- Ignition peak current and energy through the coil
- Power dissipation and IC temperatures (case and junction)
- The advised oscillator resistance for a preheat time of 600 ms ($R_{OSC(ADV)}$)
- The voltage across the filaments (V_{FILAM})
- The lamp currents in the burn state of the application ($I_{LL(BURN)}$, $I_{D(BURN)}$, $I_{LH(BURN)}$)
- The minimum and maximum rectified mains voltage ($V_{BRIDGE(MIN)}$, $V_{BRIDGE(MAX)-D}$)

5.4.1 Coil

On completion of the calculation, the tool also returns the most important coil requirements (example in [Figure 24](#)). Together with the inductance entered in [Figure 23](#) and the operating temperature of the inductor there is enough information to design a coil. Due to losses in the inductor, its operating temperature is higher than the lamp ambient temperature. When the coil is properly designed, the inductor temperature increase will be around 40 °C above the ambient temperature. When a warm lamp is switched off and then on again, the inductor should not saturate at this inductor temperature.

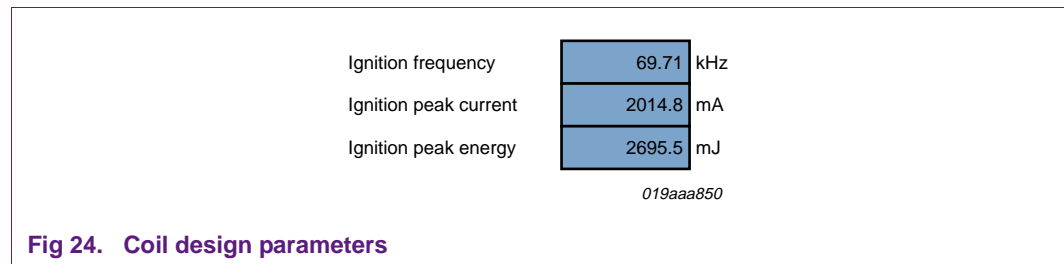

5.4.2 Thermal properties

In this section the estimated dissipated power and junction temperature in the IC are calculated. See [Figure 25](#) for an example. When the maximum ambient temperature at which the lamp needs to operate is entered, the anticipated junction temperature is calculated. The junction temperature must not exceed 150 °C. If the junction temperature does exceed 150 °C, the expected operating life time of the IC is significantly reduced.

The maximum stress allowed during the ignition phase is 2500 mA (peak) for the UBA2024B at a case temperature of 25 °C (repetition rate is less than once per hour). The maximum stress period must not be longer than 1 second.

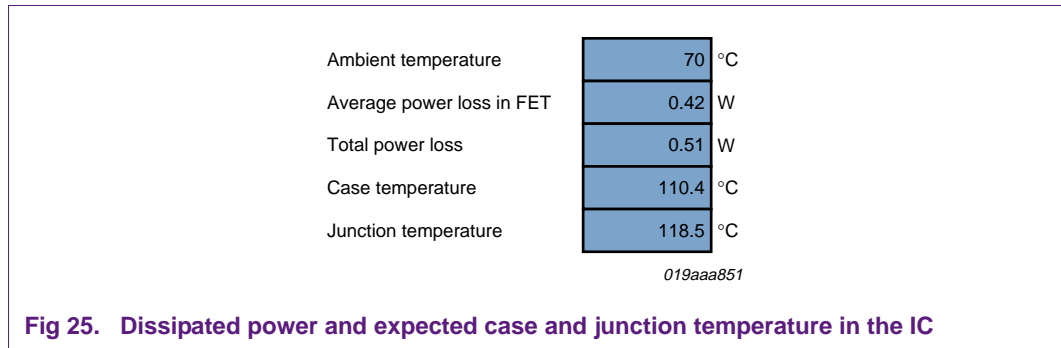

5.5 Choosing the other components

A bridge cell or separate diodes such as the 1N5062 can be used for the rectifier bridge. The 1N4007 diodes can also be used but they are not avalanche rugged.

For a lamp current ≥ 150 mA with $C_{DVDT} = 220$ pF and for a current ≥ 150 mA with $C_{DVDT} = 100$ pF, the value of C_{VDD} and C_{FS} is 10 nF.

The recommended half-bridge capacitors (C_{HB1} and C_{HB2}) are greater than 150 nF when $f_{out} = 40$ kHz to 50 kHz and greater than 220 nF when $f_{out} = 25$ kHz to 30 kHz.

The resonance frequency of the input pi filter, consisting of L_{FILT} and C_{HB} (C_{HB} being the effective capacitor as seen on pin HV of the IC (the series capacitance of C_{HB1} and C_{HB2}), must be at least two times lower than the nominal output frequency.

Remark: Performance and lifetime cannot be guaranteed by using the values given in this Section. The lamp and the UBA2024 performance interact strongly with each other and need to be qualified together as a combination.

5.6 Checking the tolerance sensitivity

In this section the stability of the result provided is verified with respect to mains fluctuations and component tolerances. After the tool has provided a solution for how to dimension the application, it can also be used to show the result when for example the mains voltage changes $\pm 5\%$, or when the resonant capacitors tolerances are taken into account.

An example in [Figure 26](#) illustrates the effect on the output power when V_{mains} increases by 10 % from 120 V (AC) to 132 V (AC). When the increased mains voltage is entered the actual burning frequency must be adapted to return $\Delta I_{(ID)} = 0$ to zero, so the user manually optimizes for operation on the edge of hard switching. In order to achieve the condition $\Delta I_{(ID)} = 0$, the frequency must be decreased. The field $P_{LAMP(AVG)}$ shows what the power is in this situation, and for the application in question this will result in a 22 % power increase from 24 W to 29.4 W.

UBA2024B CFL ballast up to 120 V (AC) without voltage doubler

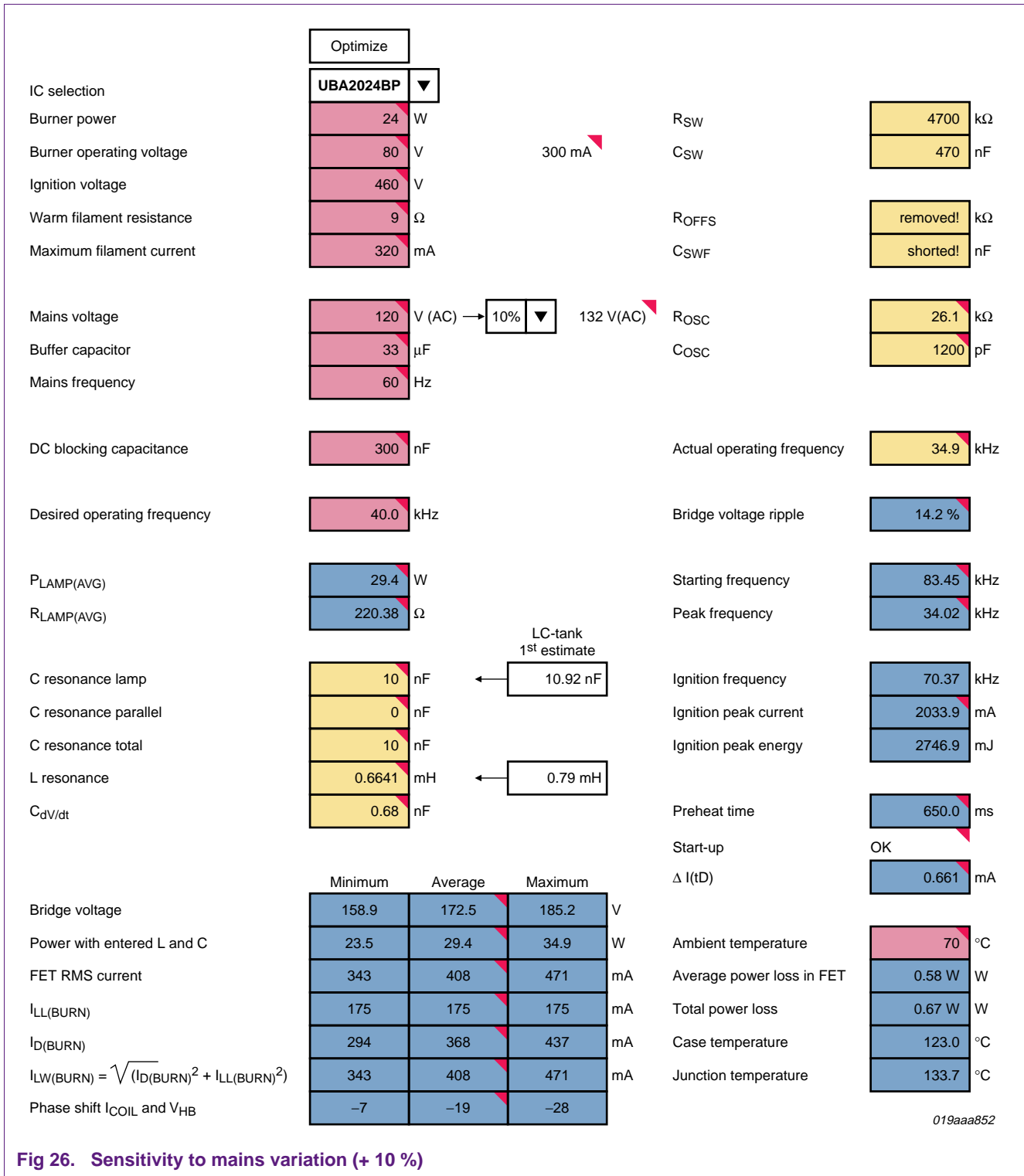

Fig 26. Sensitivity to mains variation (+ 10 %)

This procedure has also been carried out when tolerances of the resonant capacitors and inductor are taken into account. The result of this exercise is shown in [Table 4](#).

Table 4. Calculated tolerance sensitivity results

Parameter (nominal)	$V_{\text{mains}} = 120 \text{ V (AC)} = 100 \%$		$C_{\text{RS}} = 10 \text{ nF} = 100 \%$		$L = 0.66 \text{ mH} = 100 \%$	
	$V_{\text{mains}} (-10 \%)$	$V_{\text{mains}} (+10 \%)$	$C_{\text{RS}} (-5 \%)$	$C_{\text{RS}} (+5 \%)$	$L(-10 \%)$	$L(+10 \%)$
frequency (43.4 kHz)	49.1 kHz	34.9 kHz	44.7 kHz	42.3 kHz	45.5 kHz	41.6 kHz
$P_{\text{LAMP(AVG)}} (24 \text{ W})$	20.280 W	29.449 W	23.374 W	24.615 W	25.226 W	22.908 W

6. Building the application

6.1 Reference board

6.1.1 External lamp detection circuit

The NXP Semiconductors evaluation board contains an additional lamp detection circuit which is not required for mass production applications such as CFLi (see [Figure 29](#)). The functioning of this detection circuit is described in this section.

During start-up, preheat and ignition phases, the voltage at the SW pin (pin 1) increases from 0 V to 1.32 V. At the same time the amplitude of the signal on the RC pin (pin 7) increases by the same amount. However, if the lamp is not ignited, because it is broken or missing, the sweep voltage will remain below the 3 V level or even drop to 0 V. The IC will not operate in Zero Voltage Switching mode (ZVS). Large currents flow in the half-bridge causing dissipation in the IC to exceed the maximum value. The half-bridge can only withstand the high dissipation until the junction temperature reaches 150 °C.

At start-up the RC oscillator starts with an amplitude of 2 V on pin RC (pin 8). The half-bridge frequency is now running at approximately 15 % above the nominal ignition frequency. When the burner is connected to the circuit the half-bridge operates in ZVS and the C_{SW} capacitor charges. R6, R7 and C12 create an average DC voltage of the oscillator voltage on pin RC, which is basically half the amplitude. That voltage is then fed to the base of Q2-2, which functions as a comparator.

At the same time that C_{SW} is charging, C11 is charged by R3 from V_{DD} . This takes place with a time constant of $(R3/R4) \times C11$. The charging stops when the voltage on C11 reaches 1.6 V. The voltage on C11 is fed to the emitter of Q2-2 to compare it with its base voltage.

Under normal conditions during start-up, when the lamp is connected the average DC voltage from RC rises above 1.6 V at the end of the charging period for C11. The base emitter voltage of Q2-2 will remain reverse biased and will not turn on. If non-ZVS is detected in the half-bridge driver switches due to an unconnected or broken lamp, the charging of C_{SW} stops and the voltage on C_{SW} drops to 0 V. The average DC voltage on the RC pin reduces to less than 1 V and Q2-2 starts to conduct.

Q2-2 drives the latching transistor Q1-1 and the fault condition is latched by the left diode of the double diode, D5. At the same time the right diode of D5 will stop the UBA2024B half-bridge oscillator. The latch can be reset by power cycling the mains voltage with less than 1 s delay (for the test circuit this depends on the discharge time of C11 and R4). The latch circuit is designed in such a way that it is not noise sensitive. However, it is better to keep it away from the large signal tracks.

UBA2024B CFL ballast up to 120 V (AC) without voltage doubler

Typically, the circuit triggers within 0.5 s from start-up when no lamp is connected and also when a lamp is removed during operation. When the protection has tripped, the dissipated power in the IC is about 0.6 W. The IC can dissipate this power continuously.

Ensure that there is some reaction time margin (at room temperature) when choosing C11. Also, consider voltage derating of MLCC capacitors when low voltage types are used. It is advisable to choose an X7R type of at least 10 V.

The protection circuit places additional capacitive loading (about 5 pF) on pin RC. This can be significant in fixed frequency operation for small values of C_{OSC}. In this case, the value of C_{OSC} is compensated for this effect by lowering R_{OSC} from 200 kΩ to 191 kΩ (E96 series), giving an operating frequency of 45.9 kHz instead of 43.3 kHz. When the circuit is used it is advisable to add the extra 5 pF to C_{OSC}; see [Equation 4](#).

This additional capacitance can be ignored when the IC is working on the edge of hard switching, since a C_{OSC} = 1.2 nF is recommended to improve the duty cycle of the half-bridge output voltage.

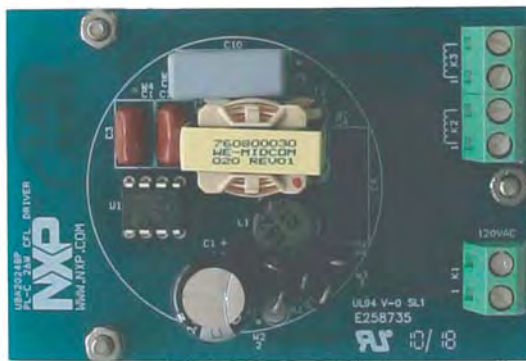
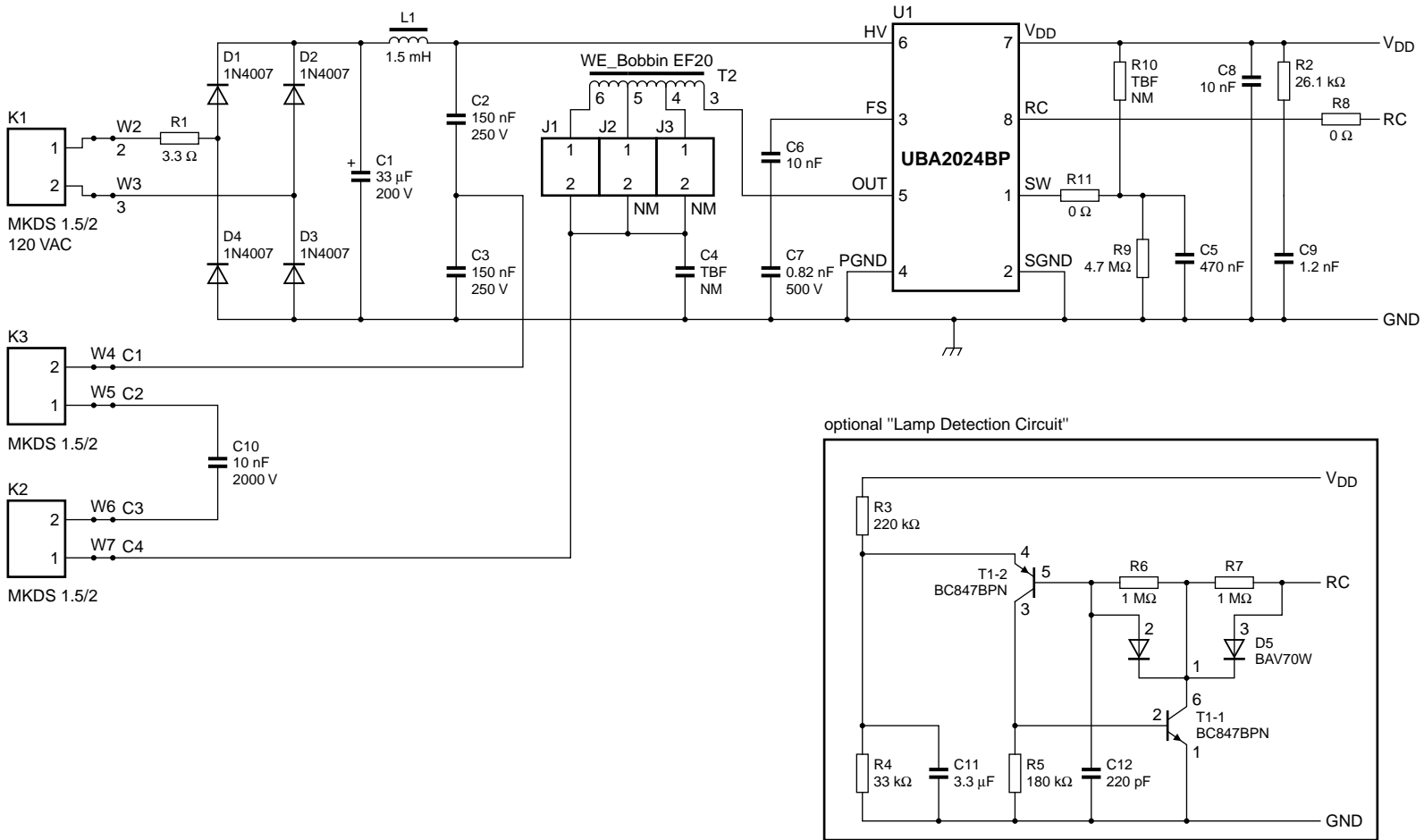

Fig 27. Photo reference board UBA2024BP (DIP8)



Fig 28. Photo reference board UBA2024BT (SO14)



019aaa853

J1, J2 and J3 are 0 Ω resistors.
 UBA2024BP:
 J1 = 0.66 mH, default set for 26 W.
 J2 = 0.98 mH, 13 W.
 J3 = 1.09 mH, 18 W.
 Do NOT short more than one jumper at the same time.

Fig 29. Circuit diagram of the UBA2024BP reference board with optional lamp detection circuit

6.2 Bill of materials

The bill of materials is given in [Table 5](#) for the application example with a PL-C 4P 26W lamp, including the external lamp detection circuit.

Table 5. Components used to build the application around the UBA2024BP for driving a PL-C 4P 26W CFL
This table applies to both the UBA2024BP and UBA2024BT reference boards

Reference	Description	Remarks	Value
R1	resistor, fusible; 3R3 / 5 %, 2W NFR	fusistor	3.3 Ω; 2 W
R2	resistor, thick film, 26K1 / 1 %, 0W1 0603	oscillator resistor	26.1 kΩ; 0.1 W; 1 %
R3 ^[1]	resistor, thick film, 220K / 5 %, 0W1 0603		220 kΩ; 0.1 W
R4 ^[1]	resistor, thick film, 33K / 5 %, 0W1 0603		33 kΩ; 0.1 W
R5 ^[1]	resistor, thick film, 180K / 5 %, 0W1 0603		180 kΩ; 0.1 W
R6, R7 ^[1]	resistor, thick film, 1M / 5 %, 0W1 0603		1 MΩ; 0.1 W
R8, R11	resistor, thick film, 0R / 1 %, 0W1 0603	short	0 Ω
R9	resistor, thick film, 4M7 / 1 %, 0W1 0603		4.7 MΩ; 0.1 W; 1 %
R10	not applicable	not mounted	not applicable
C1	capacitor, Al, El, 47 μF, 20 %, 200V KXG	high temperature electrolytic type	47 μF; 200 V
C2, C3	capacitor, 150 n, 10 %, 250V DME		150 nF; 250 V
C4	not applicable	not mounted	not applicable
C5	capacitor, ceramic, 470n, 10 %, 10V X5R 0603		470 nF; 10 V; 10 %
C6, C8	capacitor, ceramic, 10n, 20 %, 50V X7R 0603		10 nF; 50 V
C7	capacitor, ceramic, 0.82 n, 10 %, 500V X7R 1206		10 nF; 50 V
C9	capacitor, ceramic, 1n2, 5 %, 50V X7R 0603	oscillator capacitor	1.2 nF; 50 V; 5 %
C10	capacitor, 10n, 5 %, 2KV MKP	lamp capacitor	10 nF; 2 kV; 5 %
C11 ^[1]	capacitor, ceramic, 3μ3, 20 %, 10V Y5V 0805		3.3 μF; 10 V
C12 ^[1]	capacitor, ceramic, 220p, 5 %, 50V COG 0603		220 pF; 50 V; 5 %
D1, D2, D3, D4	diode, standard, 1KV, 1A	mains rectifier diode	1N4007
D5 ^[1]	diode, small signal, dual, 70V, 200mA	double diode common cathode	BAV70W
L1	Inductor RF choke 1m5H, 1R7, 0A43, 10 %	radial type	1.5 mH, 0.43 A
T1 ^[1]	Tor, dual, NPN/PNP, 45V, 100mA	PNP and NPN diode in one	BC847BPN
T2	RF choke, T-H BOBBIN EF-20	E-20 core (select inductance with jumper)	0.66 mH; J1 in place
U1 ^[2]	UBA2024BP, UBA2024BT	CFL driver IC	UBA2024BP

[1] Component(s) needed for the optional lamp detection circuit.

[2] 2 versions of the demo board are available for the UBA2024BP in a DIP8 package and the UBA2024BT in a SO14 package.

7. Layout considerations

The UBA2024B PCB layout has a considerable influence on the performance of the IC. Issues to be taken into account are:

- Coils with open magnetic circuits should not be placed opposite the IC (on the other side of the PCB). If an axial filter inductor is used for L_{FILT} , it should be placed in the same direction as the IC to minimize magnetic field pick-up.
- The oscillator pin (pin 7, RC) and the sweep pin (pin 8, SW) should be shielded from output/lamp by a ground track.
- Components on pins 7 and 8 should be placed as close to the IC as possible.
- Capacitors C_{VDD} and C_{FS} should be placed close to the IC.
- Mains input wires must not run parallel or near the half-bridge signal (pin 5, OUT) or near the output of the lamp inductor, bypassing the input filter.
- If the UBA2024BT is used, all SGND pins need to be soldered to a copper plane for effective heat transfer. This copper plane is underneath the IC and extends on both sides of the IC as far as possible. Fixing the IC to the board using thermal conductive glue also helps to keep the IC cool.

8. Quick measurements

[Table 6](#) compares the calculated values from the application development tool with the measured values. The measurements were carried out at 25 °C.

Table 6. Measured values compared with the calculated values

Values	Lamp power (W)	f_{burn} (kHz)	T_{ph} (ms)	f_{start} (kHz)	f_{ign} (kHz)	I_{LL} (mA)	I_{D} (mA)	I_{LH} (mA)	$I_{\text{ign(pk)}}$ (mA)
calculated	24	43.4	690	83.4	69.7	218	300	371	2010
measured	23.4	51.5	560	81.7	70	279	279	404	1960

Table 7. Components used in the application as calculated by the calculation spreadsheet for driving a PL-C 4P 26 W burner

Component	Value
L_{RES}	0.66 mH
C_{RS}	10 nF
C_{RP}	not mounted
C_{DVDT}	0.82 nF
R_{OSC}	26.1 k Ω
C_{OSC}	1200 pF

9. Start-up waveforms

The measured waveforms are shown of the lamp voltage and lamp current (Figure 30) and coil current (Figure 31) during preheat.

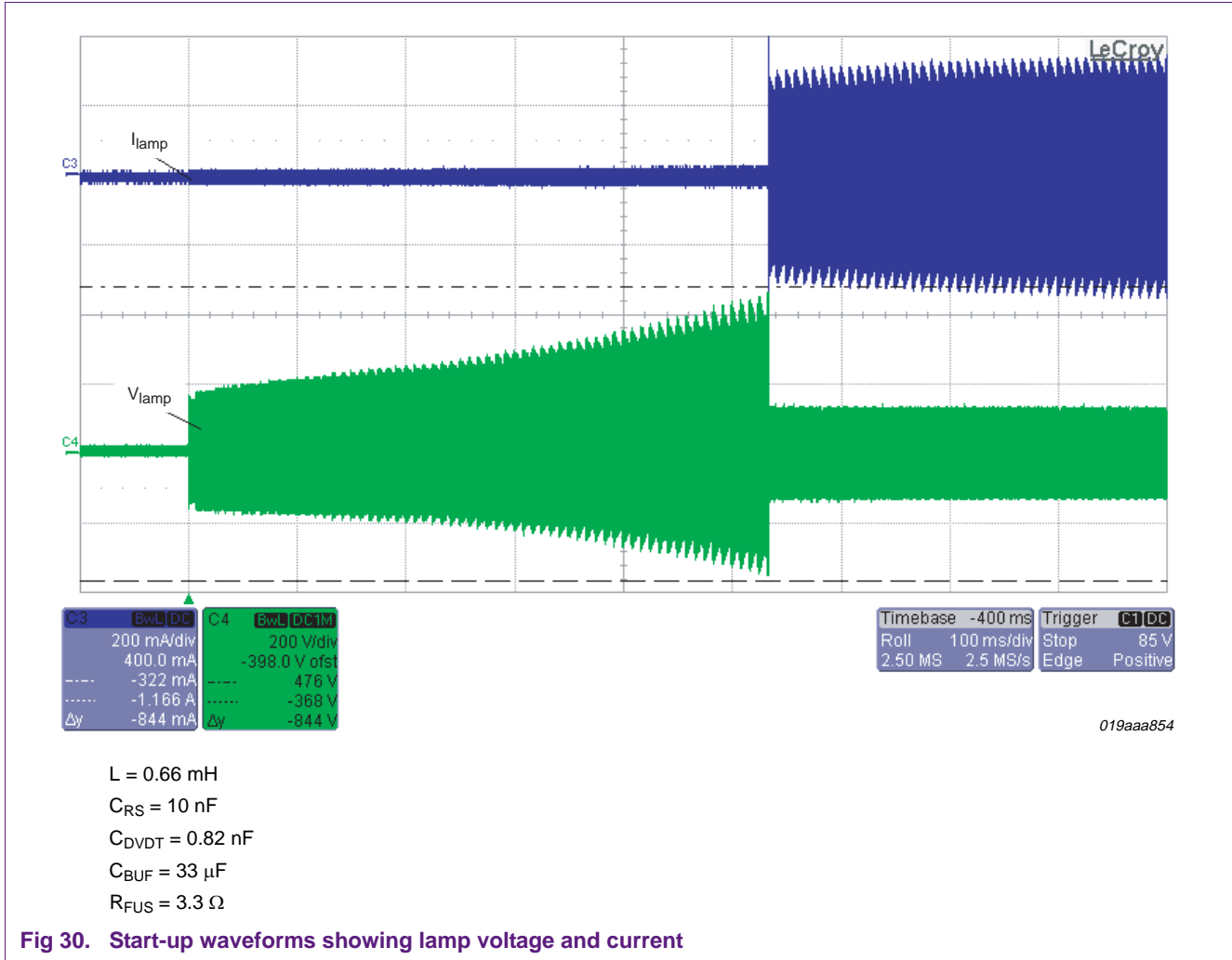

Remark: Note that the lamp ignites without glow. If lamp glow was present it would indicate a lamp current before the lamp has ignited. This is not the case here. The ignition peak voltage is 470 V.

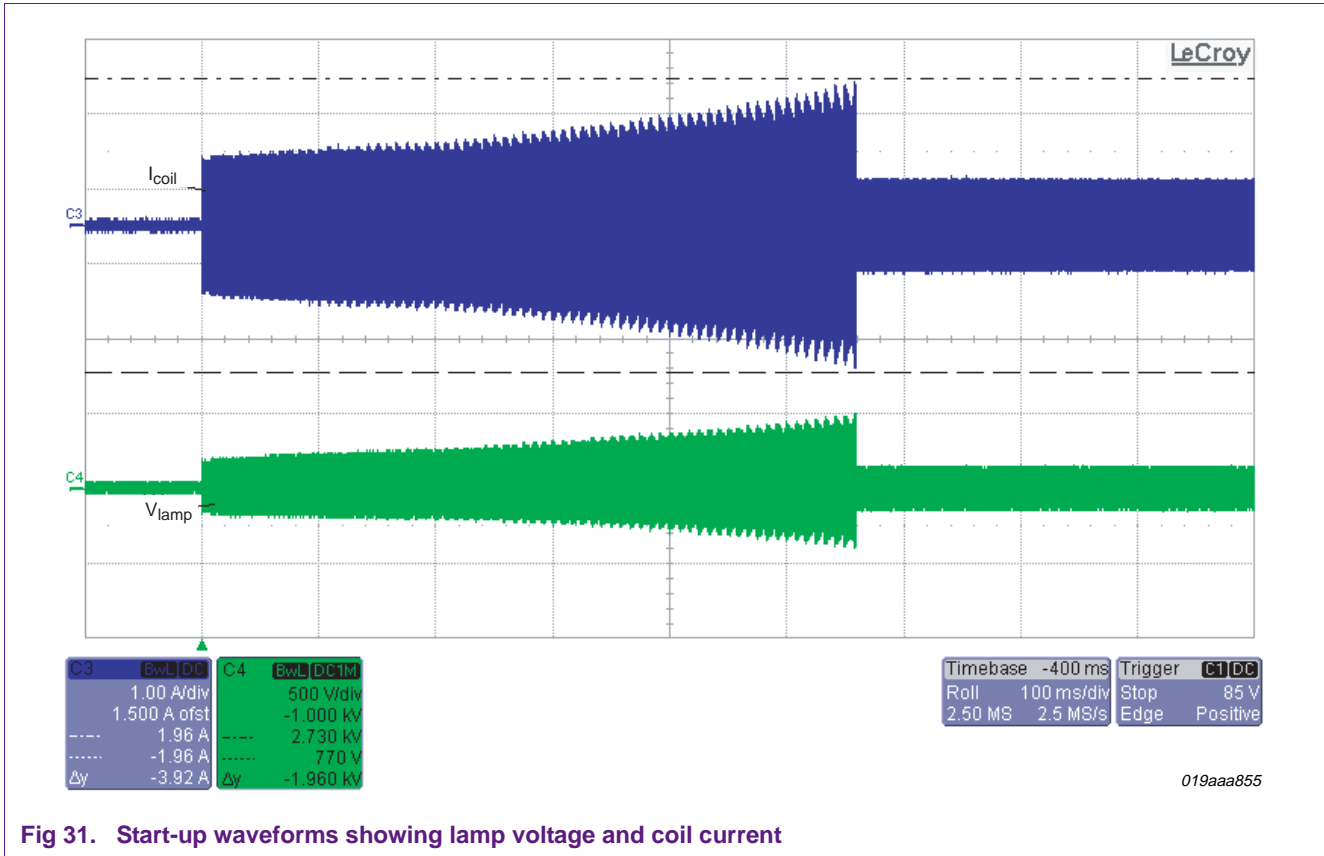

The measured peak value of the coil current equals 1960 mA.

10. Steady state waveforms

The waveforms in [Figure 32](#) are shown 15 minutes after power on.

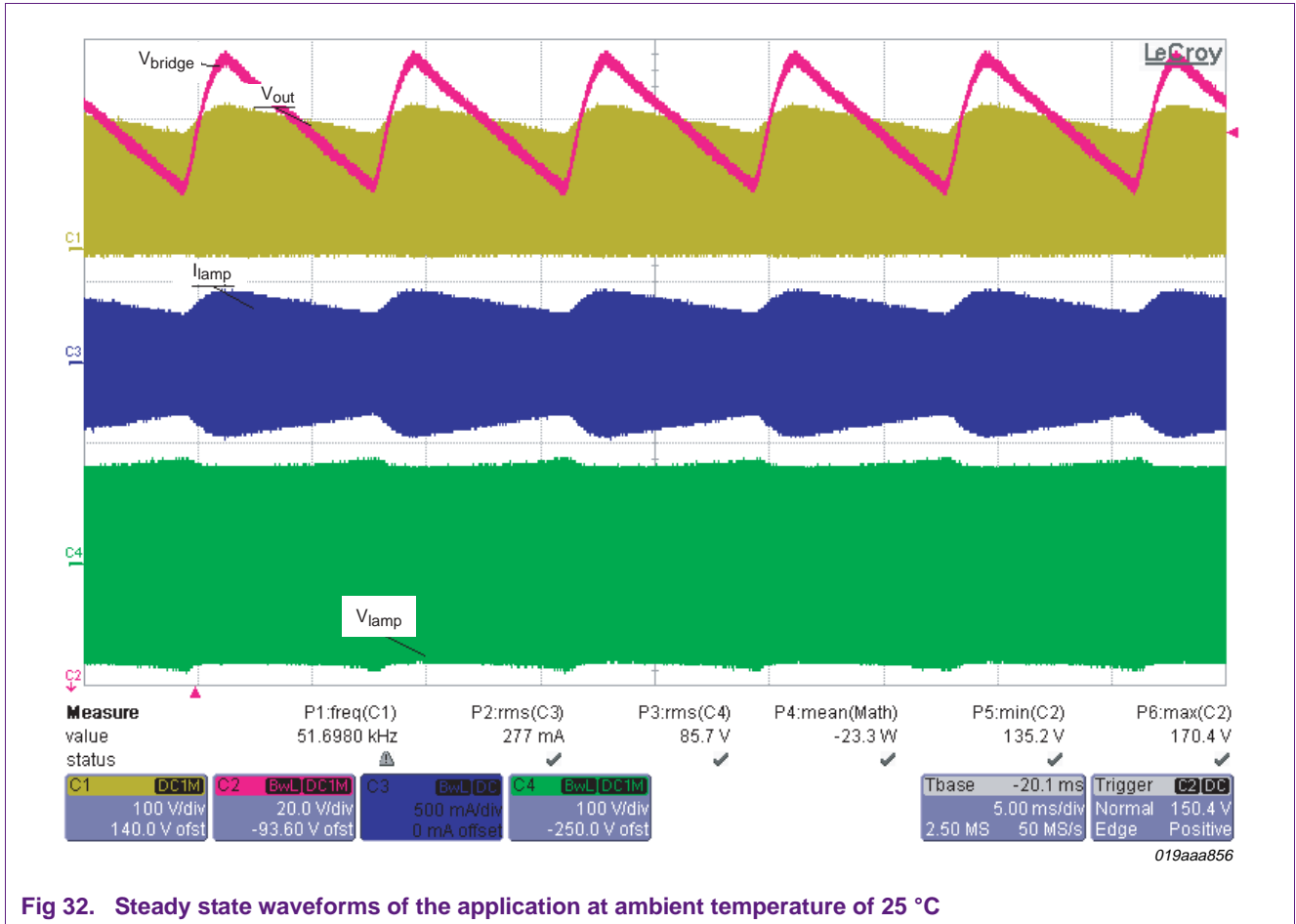

Fig 32. Steady state waveforms of the application at ambient temperature of 25 °C

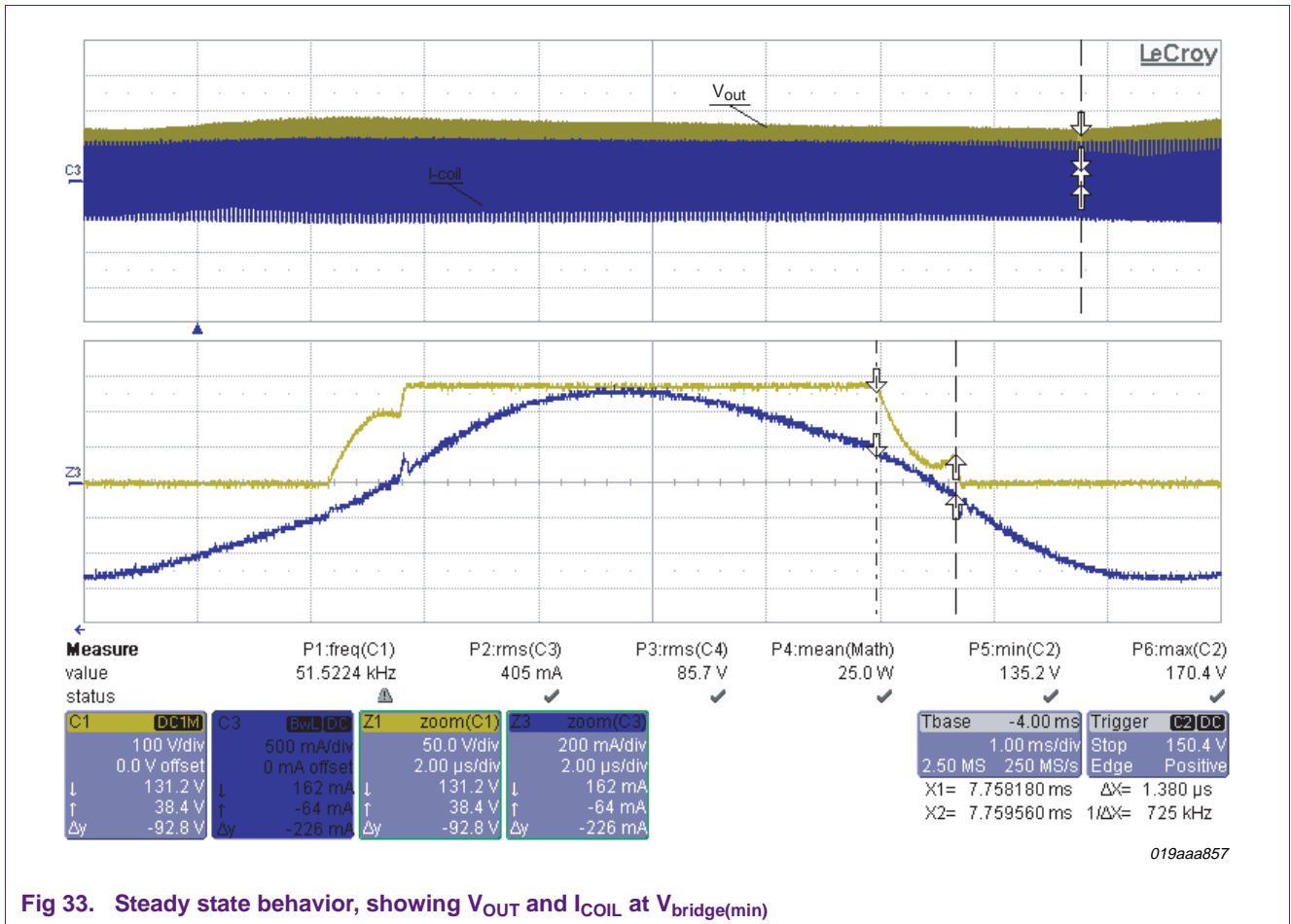

Fig 33. Steady state behavior, showing V_{OUT} and I_{COIL} at $V_{bridge(min)}$

In [Figure 33](#) the measured coil current is shown during the dead time at the trailing edge of the half-bridge voltage. Hard switching is seen here, while the frequency is controlled by zero crossing of the coil current. The shape of V_{OUT} has been changed such that the slopes are not so steep by increasing the calculated C_{DVDT} from 0.68 nF to 0.82 nF.

11. What if...

This section shows examples of practical problems such as coil saturation and lamp glow.

11.1 Coil saturation

Figure 34 illustrates what happens when the coil goes into saturation during ignition.

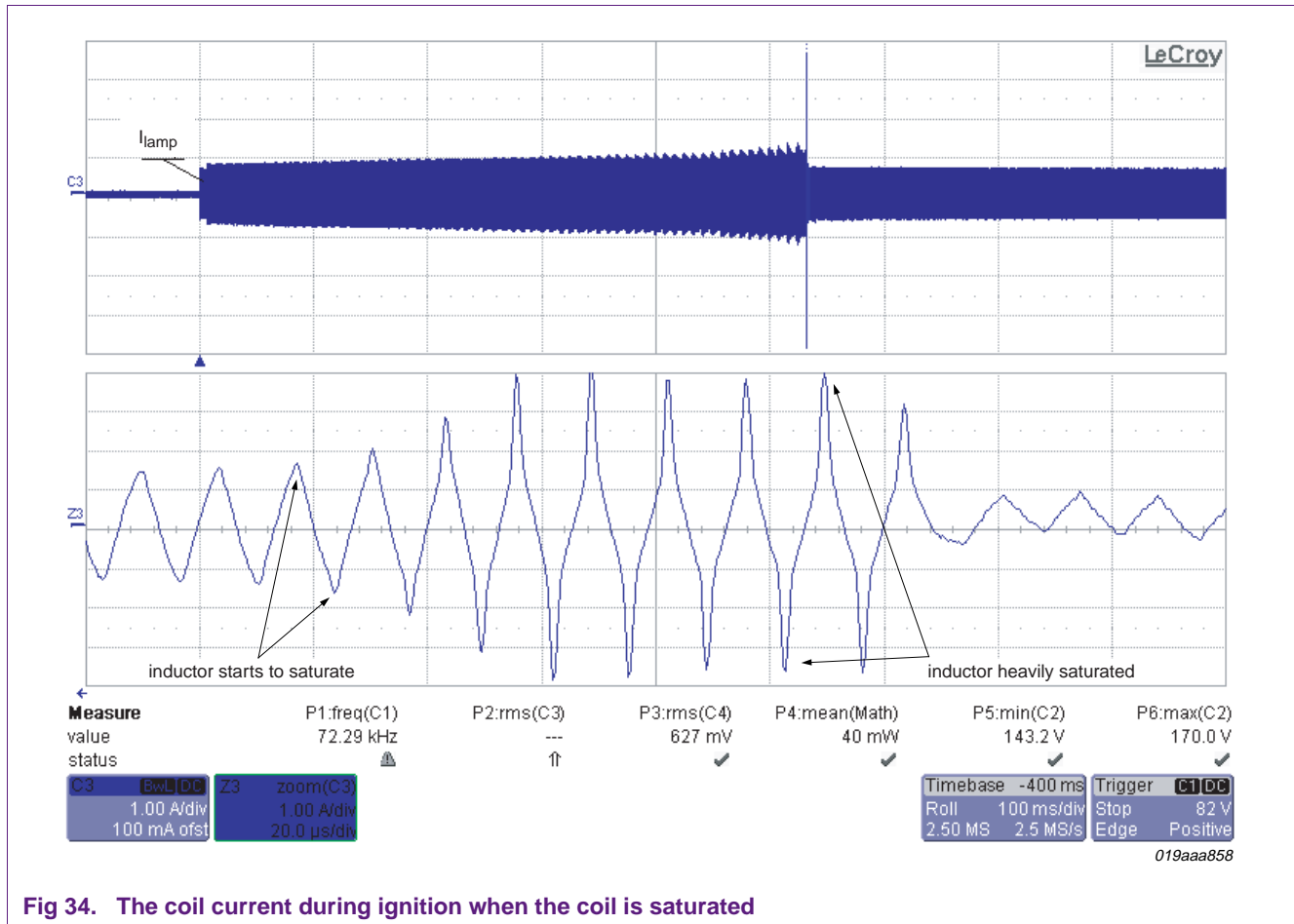

In this case the coil current will show excessive peaks which in turn results in the integrated half-bridge switches going into saturation and consequently damaging the IC.

11.2 Lamp glow

Lamp glow is mainly caused by improper preheating of the filaments

Either a quasi-preheat that is too short or a voltage rise that is too slow will increase the glow time of the lamp. This reduces the lifetime of the lamp. During the glow phase the lamp is ignited, but the filaments and the gas inside the lamp are not at their final operating temperature.

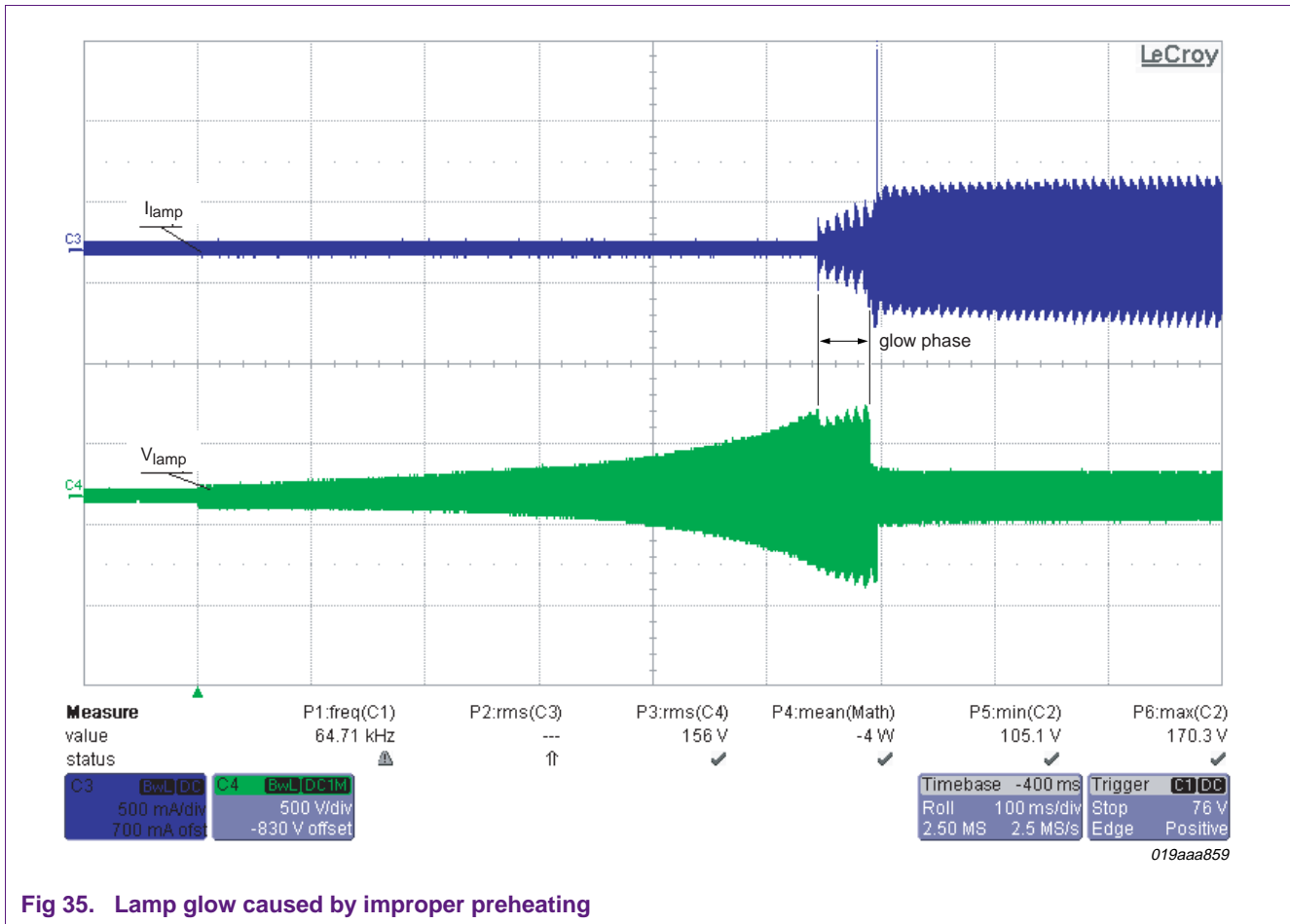

Fig 35. Lamp glow caused by improper preheating

In [Figure 35](#) it is clear that there is still a high voltage present at the lamp while at the same time lamp current is flowing. When the filaments and gas inside the lamp have reached their normal operating temperature, the voltage at the lamp will drop to its normal operating value.

This is the preheating method shown in [Figure 16](#) referred to as quasi-preheat and starting at 100 kHz.

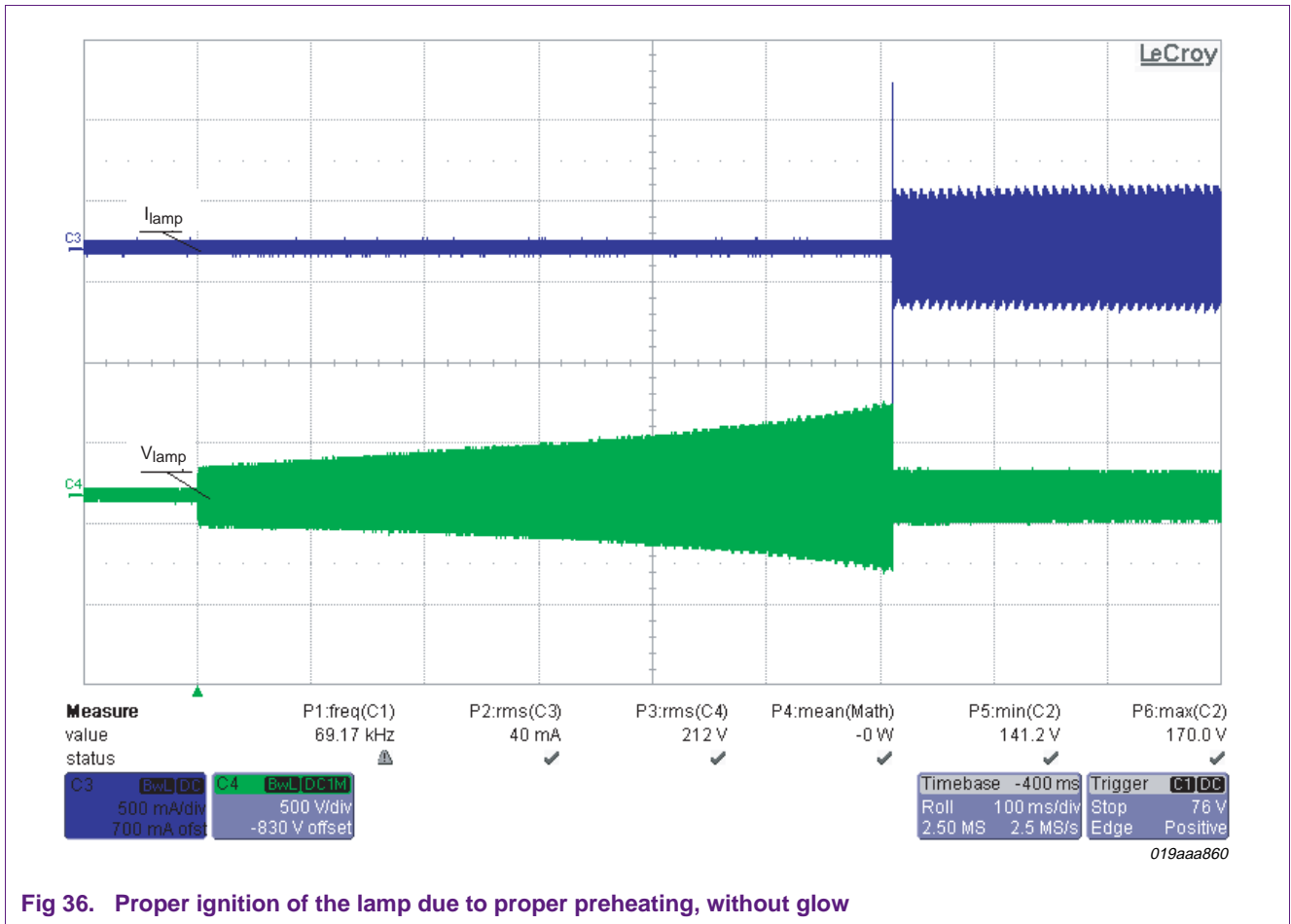

Figure 36 shows the ignition of a lamp that is preheated as shown in Figure 16 where preheating starts at the ignition frequency plus an additional 10 kHz. Note that there is no lamp glow present due to the filaments having enough time to reach the correct operating temperature. This method of preheating will increase the life time of the lamp and ensure that it will pass any on/off test of minimum 10,000 repetitions.

12. References

- [1] **Application note AN10713** — 18 W CFL lamp design using UBA2024 application development tool and application examples
- [2] **Data sheet UBA2024** — Half-bridge power IC for CFL lamps

13. Legal information

13.1 Definitions

Draft — The document is a draft version only. The content is still under internal review and subject to formal approval, which may result in modifications or additions. NXP Semiconductors does not give any representations or warranties as to the accuracy or completeness of information included herein and shall have no liability for the consequences of use of such information.

13.2 Disclaimers

Limited warranty and liability — Information in this document is believed to be accurate and reliable. However, NXP Semiconductors does not give any representations or warranties, expressed or implied, as to the accuracy or completeness of such information and shall have no liability for the consequences of use of such information.

In no event shall NXP Semiconductors be liable for any indirect, incidental, punitive, special or consequential damages (including - without limitation - lost profits, lost savings, business interruption, costs related to the removal or replacement of any products or rework charges) whether or not such damages are based on tort (including negligence), warranty, breach of contract or any other legal theory.

Notwithstanding any damages that customer might incur for any reason whatsoever, NXP Semiconductors' aggregate and cumulative liability towards customer for the products described herein shall be limited in accordance with the *Terms and conditions of commercial sale* of NXP Semiconductors.

Right to make changes — NXP Semiconductors reserves the right to make changes to information published in this document, including without limitation specifications and product descriptions, at any time and without notice. This document supersedes and replaces all information supplied prior to the publication hereof.

Suitability for use — NXP Semiconductors products are not designed, authorized or warranted to be suitable for use in life support, life-critical or safety-critical systems or equipment, nor in applications where failure or

malfunction of an NXP Semiconductors product can reasonably be expected to result in personal injury, death or severe property or environmental damage. NXP Semiconductors accepts no liability for inclusion and/or use of NXP Semiconductors products in such equipment or applications and therefore such inclusion and/or use is at the customer's own risk.

Applications — Applications that are described herein for any of these products are for illustrative purposes only. NXP Semiconductors makes no representation or warranty that such applications will be suitable for the specified use without further testing or modification.

Customers are responsible for the design and operation of their applications and products using NXP Semiconductors products, and NXP Semiconductors accepts no liability for any assistance with applications or customer product design. It is customer's sole responsibility to determine whether the NXP Semiconductors product is suitable and fit for the customer's applications and products planned, as well as for the planned application and use of customer's third party customer(s). Customers should provide appropriate design and operating safeguards to minimize the risks associated with their applications and products.

NXP Semiconductors does not accept any liability related to any default, damage, costs or problem which is based on any weakness or default in the customer's applications or products, or the application or use by customer's third party customer(s). Customer is responsible for doing all necessary testing for the customer's applications and products using NXP Semiconductors products in order to avoid a default of the applications and the products or of the application or use by customer's third party customer(s). NXP does not accept any liability in this respect.

Export control — This document as well as the item(s) described herein may be subject to export control regulations. Export might require a prior authorization from national authorities.

13.3 Trademarks

Notice: All referenced brands, product names, service names and trademarks are the property of their respective owners.

14. Tables

Table 1. The UBA2024 family3
Table 2. UBA2024 application range3
Table 3. Advised values for the standard input configuration18
Table 4. Calculated tolerance sensitivity results27
Table 5. Components used to build the application around the UBA2024BP for driving a PL-C 4P 26W CFL30
Table 6. Measured values compared with the calculated values31
Table 7. Components used in the application as calculated by the calculation spreadsheet for driving a PL-C 4P 26 W burner31

15. Figures

Fig 1.	Mains input configurations for 100 V (AC) to 120 V (AC)	4	Fig 35.	Lamp glow caused by improper preheating	37
Fig 2.	Application diagram for the UBA2024BP	5	Fig 36.	Proper ignition of the lamp due to proper preheating, without glow	38
Fig 3.	Application diagram for the UBA2024BT	5			
Fig 4.	Application diagram for the UBA2024BP with inductive preheating	6			
Fig 5.	Lamp currents	6			
Fig 6.	Resonant tank with a burner driven by a square wave voltage	7			
Fig 7.	Resonant gain in a fixed frequency application with a resonant gain tank	8			
Fig 8.	Resonant gain in a feedback controlled frequency application	8			
Fig 9.	Example of a transfer function for a resonant gain LC-tank loaded with an ignited burner	10			
Fig 10.	Half-bridge output voltage and coil current with $C_{D\text{VDT}}$ controlled frequency	10			
Fig 11.	Half-bridge output voltage and coil current with zero crossing controlled frequency	12			
Fig 12.	Hard switching occurrence	13			
Fig 13.	Schematic diagram of a fixed frequency application with new SW pin circuitry	13			
Fig 14.	Controlled preheat current	14			
Fig 15.	SW circuit for a frequency controlled feedback operated application	15			
Fig 16.	Preheat and ignition, preheat current as a function of time	16			
Fig 17.	SW circuit for a fixed frequency operated application	17			
Fig 18.	Entering the design parameters for a 26 W lamp	19			
Fig 19.	Average burner power as a function of the rectified bridge voltage	21			
Fig 20.	Burner power as a function of frequency	21			
Fig 21.	Burner voltage, filament current and frequency as a function of time during start-up	22			
Fig 22.	Calculated lamp power variation	22			
Fig 23.	Input/output data fields	23			
Fig 24.	Coil design parameters	24			
Fig 25.	Dissipated power and expected case and junction temperature in the IC	25			
Fig 26.	Sensitivity to mains variation (+ 10 %)	26			
Fig 27.	Photo reference board UBA2024BP (DIP8)	28			
Fig 28.	Photo reference board UBA2024BT (SO14)	28			
Fig 29.	Circuit diagram of the UBA2024BP reference board with optional lamp detection circuit	29			
Fig 30.	Start-up waveforms showing lamp voltage and current	32			
Fig 31.	Start-up waveforms showing lamp voltage and coil current	33			
Fig 32.	Steady state waveforms of the application at ambient temperature of 25 °C	34			
Fig 33.	Steady state behavior, showing V_{OUT} and I_{COIL} at $V_{\text{bridge(min)}}$	35			
Fig 34.	The coil current during ignition when the coil is saturated	36			

16. Contents

1	Introduction	3
1.1	UBA2024 family features	4
1.2	System benefits	4
1.3	UBA2024B benefits	4
2	Circuit diagrams	5
3	Modes of lamp power control	7
3.1	Fixed frequency operation	8
3.2	Feedback controlled frequency operation	9
3.2.1	Feedback controlled frequency using C_{DVDT}	10
3.2.2	Feedback controlled frequency using zero crossing of the coil current	11
3.2.3	Losses due to hard switching	12
4	Preheating	13
4.1	Start-up of a feedback controlled frequency application	14
4.2	Start-up of a fixed frequency application	16
5	Design of a 26 W non-dimmable CFL	17
5.1	Selecting a buffer capacitor and fusistor	17
5.2	Using the calculation tool	18
5.2.1	Input values	18
5.3	Calculation algorithm	20
5.4	Calculation results	20
5.4.1	Coil	24
5.4.2	Thermal properties	24
5.5	Choosing the other components	25
5.6	Checking the tolerance sensitivity	25
6	Building the application	27
6.1	Reference board	27
6.1.1	External lamp detection circuit	27
6.2	Bill of materials	30
7	Layout considerations	31
8	Quick measurements	31
9	Start-up waveforms	32
10	Steady state waveforms	34
11	What if...	36
11.1	Coil saturation	36
11.2	Lamp glow	37
12	References	39
13	Legal information	40
13.1	Definitions	40
13.2	Disclaimers	40
13.3	Trademarks	40
14	Tables	41
15	Figures	42
16	Contents	43

Please be aware that important notices concerning this document and the product(s) described herein, have been included in section 'Legal information'.

© NXP B.V. 2010.

All rights reserved.

For more information, please visit: <http://www.nxp.com>

For sales office addresses, please send an email to: salesaddresses@nxp.com

Date of release: 13 December 2010

Document identifier: AN10966