

NOTE: The theory in this application note is still applicable, but some of the products referenced may be discontinued.

**AN955**

## A Cost Effective VHF Amplifier for Land Mobile Radios

Prepared by: Ken Dufour  
Motorola Power Products Division

### INTRODUCTION

This application note describes a two stage, 30 watt VHF amplifier featuring high-gain, broad bandwidth and outstanding ruggedness to load mismatch, achieved by use of the new MRF1946A power transistor. It uses a die geometry intended for RF power devices operating in the UHF region. The emitter periphery (EP) to base area (BA) ratio of this die is 4.9, up from the normal EP/BA range of 1.5 to 3.5 for VHF devices. Power sharing and current sharing in the chip are controlled with diffused emitter resistors. The end result is a VHF transistor with very high power gain (10 + dB), sufficient so that processing steps can be taken to provide tolerance to load mismatch while still

maintaining excellent performance. By mounting this die in the 0.380 flange or stud package and providing characterization data that spans 136 to 220 MHz, Motorola has provided a very versatile component for the RF designer.

### CIRCUIT DESCRIPTION

Smith chart techniques were used to develop the two stage amplifier shown pictorially in Figure 1 and schematically in Figure 2. The end result is an amplifier that can produce 20 dB overall gain in the specified band (150 to 175 MHz), with a midband efficiency of 50 percent. The Motorola MRF237 was selected for the driver stage. This common emitter (TO-39) RF power transistor produces

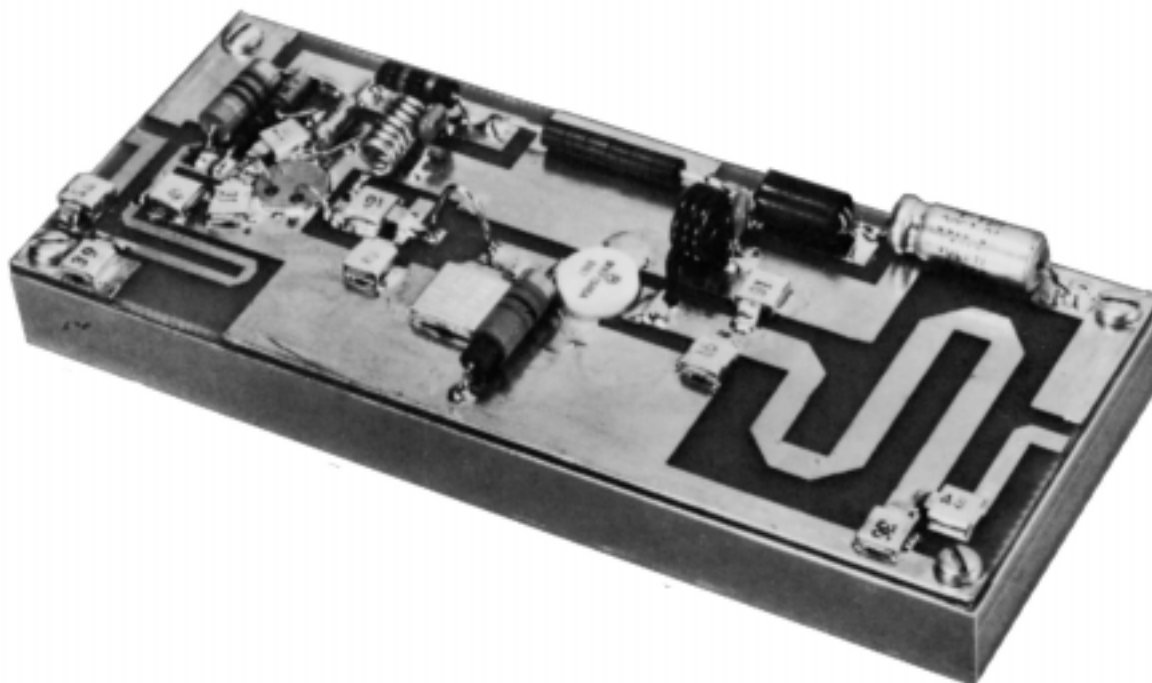
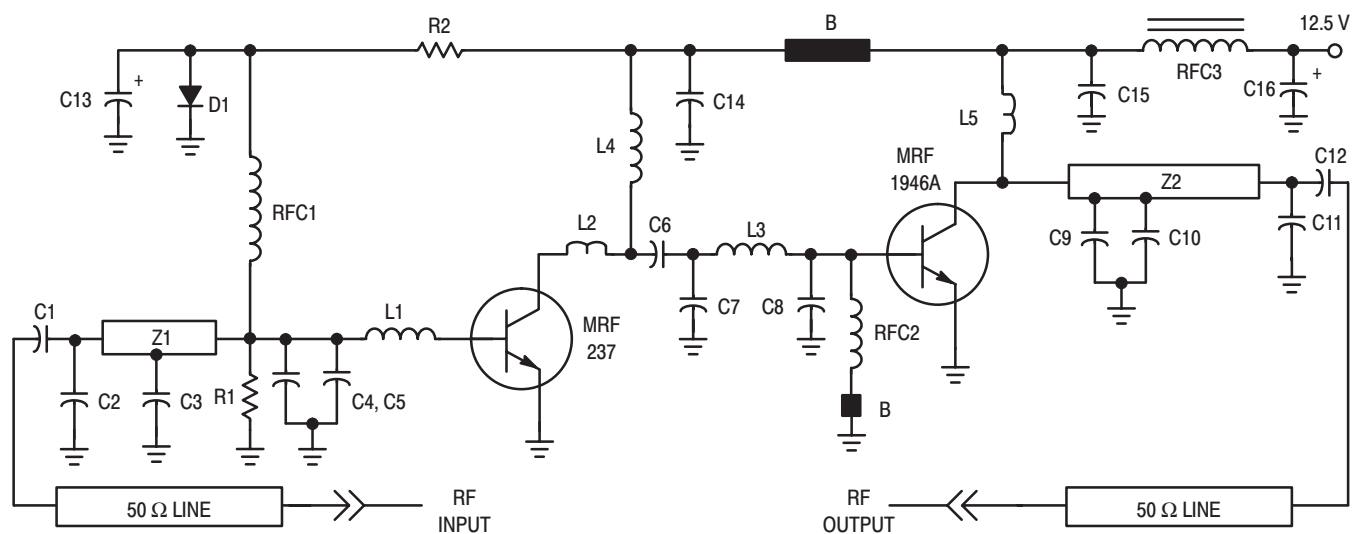

Figure 1. Engineering Model of MRF1946A Wideband Amplifier

high-gain, is easy to mount and is cost effective. In this design, the MRF237 is inserted into a hole in the circuit board and soldered to the ground plane for heat sinking, as shown in Figures 1 and 3. This method of attachment also provides a very effective emitter ground connection. By introducing a small amount of forward bias (5–15 mA) to the MRF237, it will track low drive levels and help maintain stability in the input stage. The amplifier is constructed on 1/16", double sided G-10 board with 2 ounce copper cladding. A photomaster of the printed circuit board is shown in Figure 4. The top and bottom ground planes of the board are connected by wrapping the board edges with thin copper foil (0.002") and then soldering it in place. Figures 1 and 3 illustrate how and where the board edges are wrapped in the prototype amplifier. No eyelets or plated-through-holes are required to achieve the level of performance noted here. Printed lines are used to match the devices' input and output impedance to 50 ohms, and an inductor and two capacitors

form the interstage match. This allows some flexibility in shaping the overall frequency response and helps conserve board area. The MRF1946A stage is operated in Class C and is mounted to the heatsink using conventional methods, i.e.; an 8–32 stud inserted into an appropriately prepared heatsink. An alternate packaging arrangement, the 0.380 flange, allows one to attach the transistor to the topside of the heatsink with two screws. A Motorola Application Note on mounting techniques for various semiconductors is available and provides detailed information on installing either of these package styles (see reference 1). Additional information on thermal considerations can be found in reference 2. Performance of the amplifier is illustrated in Figures 5, 6 and 7. Figure 5 is a plot of  $P_{out}$  versus  $P_{in}$  at 160 MHz, 12.5 volts; Figure 6 shows output power, input VSWR and collector efficiency as functions of frequency; while Figure 7 demonstrates harmonic content for 30 watts output power.



- C1 = 56 pF Dura Mica
- C2 = 39 pF Mini-Unelco
- C3, C7 = 68 pF Mini-Unelco
- C4, C5, C6, C9, C10 = 91 pF Mini-Unelco
- C8 = 250 pF Unelco J101
- C11 = 36 pF Mini-Unelco
- C12 = 43 pF Mini-Unelco
- C13 = 1  $\mu$ F, 25 V Tantalum
- C14, C15 = 0.1  $\mu$ F Mono-Block
- C16 = 10  $\mu$ F 25 V Electrolytic

- D1 = Diode, 1N4933 or Equivalent
- L1 = Base Lead Cut to 0.4", Formed Into Loop
- L2 = Collector Lead Cut to 0.35", Formed Into Loop
- L3 = 0.7" #18 AWG Into Loop
- L4 = 7 Turns #18 AWG, 1/8" ID
- L5 = 3 Turns #16 Enam, 3/16" ID
- R1 = 10  $\Omega$ , 1/4 W Carbon

- R2 = 1500  $\Omega$ , 1/2 W (Select For Most Appropriate ICQ)
- RFC1 = 10  $\mu$ H Molded Choke
- RFC2 = 0.15  $\mu$ H Molded Choke
- RFC3 = VK200 – 4B Choke
- Z1, Z2 = Printed Line
- Z3 = 50 Ohm Printed Line
- B = Ferroxcube Ferrite Bead 56-590-65-3B

Figure 2. Schematic Diagram of MRF1946A Wideband Amplifier

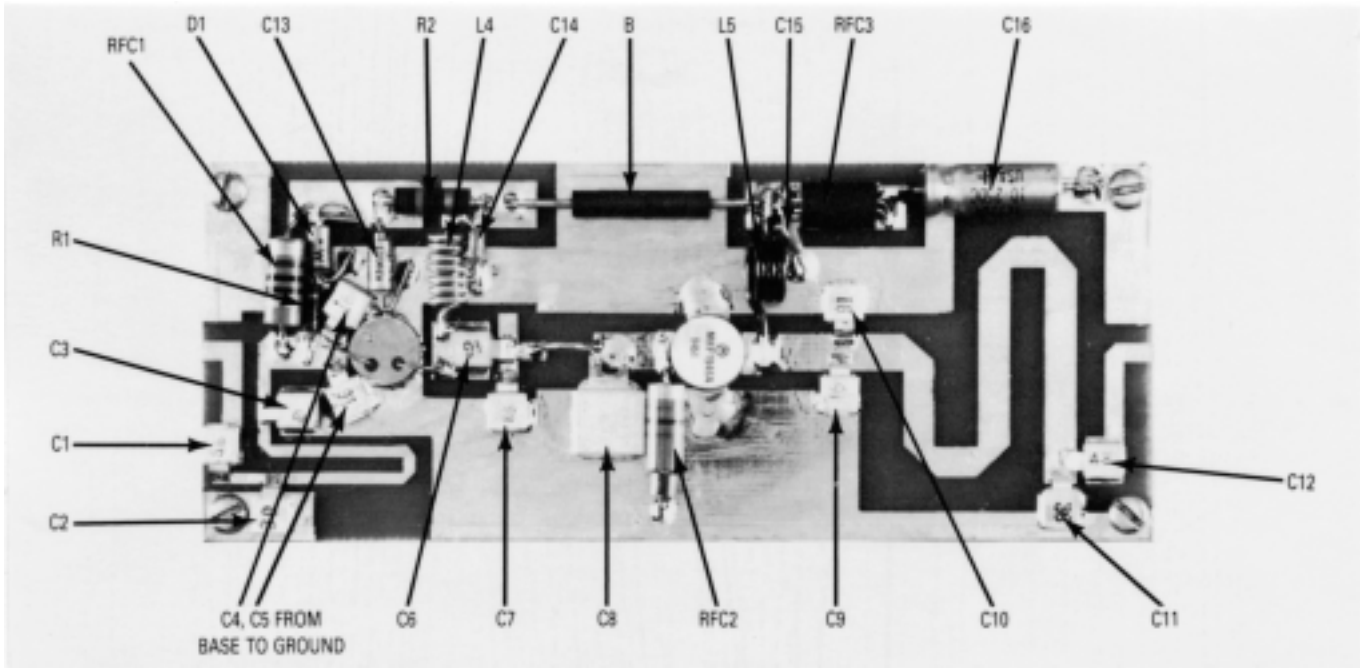
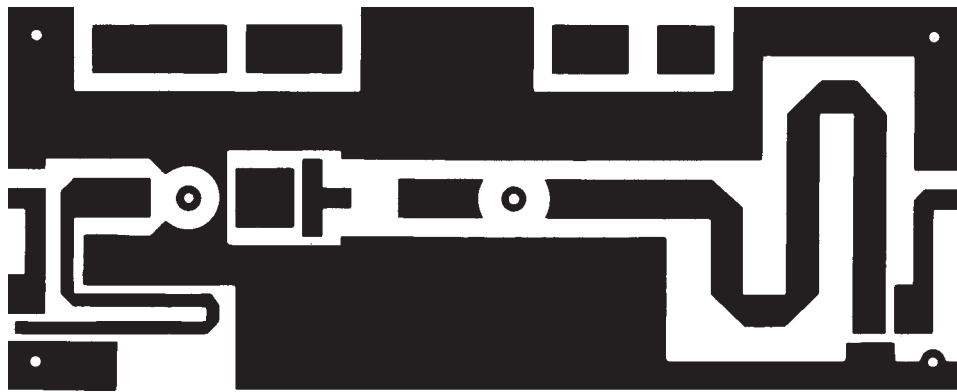

Figure 3. Parts Placement



NOTE: Not to scale.

Figure 4. PCB Photomaster

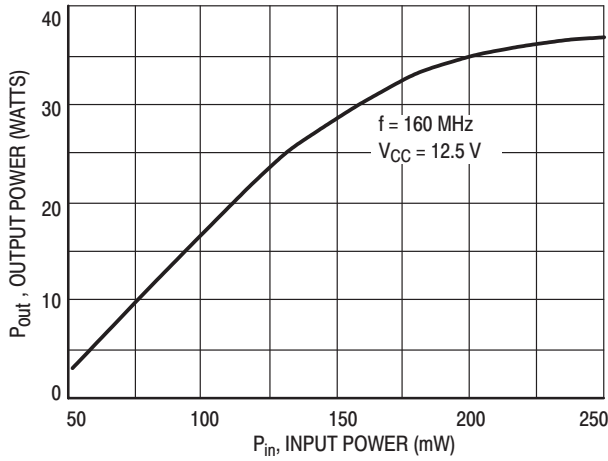

Figure 5. Output Power versus Input Power

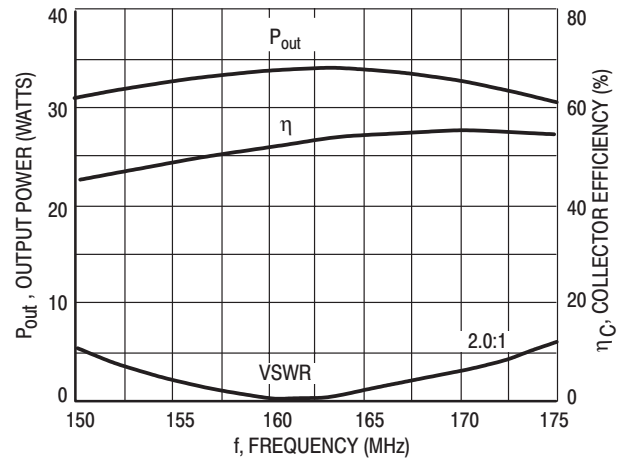

Figure 6. Output Power, Efficiency, and Input VSWR versus Frequency

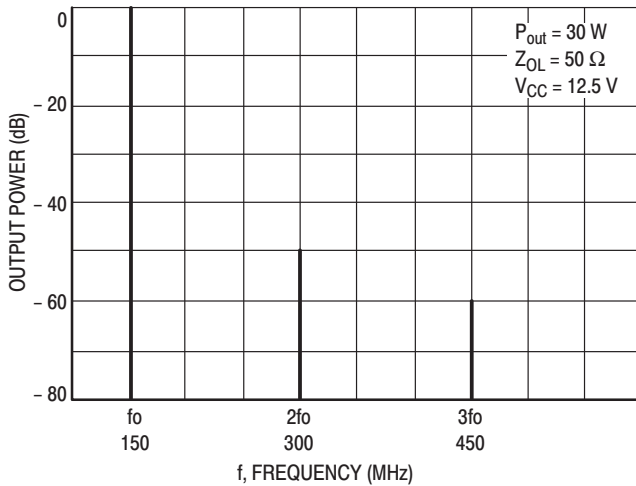

Figure 7. Output Spectrum

### CONCLUSIONS

The two-stage amplifier described produces greater than 20 dB gain with 30 watts of output power over the frequency range of 150 to 175 MHz. Ruggedness and stability are achieved by use of the new MRF1946/A power transistor. The amplifier illustrates that relatively unsophisticated construction techniques properly implemented with the appropriate high gain devices can provide a cost effective 30 watt VHF amplifier for land mobile applications.

### REFERENCES

1. Roehr, Bill: Mounting Techniques for Power Semiconductors, AN778. Motorola Semiconductor Products, Inc.
2. Johnsen, Robert J.: Thermal Rating of RF Power Transistors, AN790. Motorola Semiconductor Products, Inc.







Motorola reserves the right to make changes without further notice to any products herein. Motorola makes no warranty, representation or guarantee regarding the suitability of its products for any particular purpose, nor does Motorola assume any liability arising out of the application or use of any product or circuit, and specifically disclaims any and all liability, including without limitation consequential or incidental damages. "Typical" parameters can and do vary in different applications. All operating parameters, including "Typicals" must be validated for each customer application by customer's technical experts. Motorola does not convey any license under its patent rights nor the rights of others. Motorola products are not designed, intended, or authorized for use as components in systems intended for surgical implant into the body, or other applications intended to support or sustain life, or for any other application in which the failure of the Motorola product could create a situation where personal injury or death may occur. Should Buyer purchase or use Motorola products for any such unintended or unauthorized application, Buyer shall indemnify and hold Motorola and its officers, employees, subsidiaries, affiliates, and distributors harmless against all claims, costs, damages, and expenses, and reasonable attorney fees arising out of, directly or indirectly, any claim of personal injury or death associated with such unintended or unauthorized use, even if such claim alleges that Motorola was negligent regarding the design or manufacture of the part. Motorola and  are registered trademarks of Motorola, Inc. Motorola, Inc. is an Equal Opportunity/Affirmative Action Employer.

**Literature Distribution Centers:**

USA: Motorola Literature Distribution; P.O. Box 20912; Phoenix, Arizona 85036.

EUROPE: Motorola Ltd.; European Literature Centre; 88 Tanners Drive, Blakelands, Milton Keynes, MK14 5BP, England.

JAPAN: Nippon Motorola Ltd.; 4-32-1, Nishi-Gotanda, Shinagawa-ku, Tokyo 141, Japan.

ASIA PACIFIC: Motorola Semiconductors H.K. Ltd.; Silicon Harbour Center, No. 2 Dai King Street, Tai Po Industrial Estate, Tai Po, N.T., Hong Kong.

**MOTOROLA****For More Information On This Product,  
Go to: [www.freescale.com](http://www.freescale.com)**

AN955/D