



# UM10533

## TEA1723BT GreenChip SP low standby power SMPS demo board

Rev. 1 — 21 May 2012

User manual

### Document information

Info	Content
<b>Keywords</b>	TEA1723BT, ultra-low standby power, constant output voltage, constant output current, primary sensing, integrated high-voltage switch, integrated high-voltage start-up, tablet charger, 5 V/2.1 A supply
<b>Abstract</b>	This user manual describes an 11 W Constant Voltage/Constant Current (CV/CC) universal input power supply for tablet adapters/chargers. This demo board is based on the GreenChip SP TEA1723BT. GreenChip SP TEA1723BT enables low no-load power consumption <30 mW. The TEA1723BT design ensures a low external component count for cost-effective applications. In addition, the TEA1723BT provides advanced control modes for optimal performance. The TEA1723BT integrates the 700 V power MOSFET switch and SMPS controller.



## Revision history

Rev	Date	Description
v.1	20120521	first issue

## Contact information

For more information, please visit: <http://www.nxp.com>

For sales office addresses, please send an email to: [salesaddresses@nxp.com](mailto:salesaddresses@nxp.com)

## 1. Introduction

**WARNING**

**Lethal voltage and fire ignition hazard**



The non-insulated high voltages that are present when operating this product, constitute a risk of electric shock, personal injury, death and/or ignition of fire.

This product is intended for evaluation purposes only. It shall be operated in a designated test area by personnel qualified according to local requirements and labor laws to work with non-insulated mains voltages and high-voltage circuits. This product shall never be operated unattended.

This user manual describes an 11 W Constant Voltage or Constant Current (CV/CC) universal input power supply for tablet adapters and chargers. This demo board is based on the TEA1723BT GreenChip SP integrated circuit.

The TEA1723BT GreenChip SP provides ultra-low no-load power consumption without using additional external components. Designs are cost-effective using the TEA1723BT GreenChip SP because only a few external components are needed in a typical application. In addition, the TEA1723BT provides advanced control modes for optimal performance. The TEA1723BT integrates the 700 V power MOSFET switch and SMPS controller.

**Remark:** All voltages are in V (AC) unless otherwise stated

## 2. Safety Warning

The complete demo board application is AC mains voltage powered. Avoid touching the board when power is applied. An isolated housing is obligatory when used in uncontrolled, non-laboratory environments. Always provide galvanic isolation of the mains phase using a variable transformer. The following symbols identify isolated and non-isolated devices.

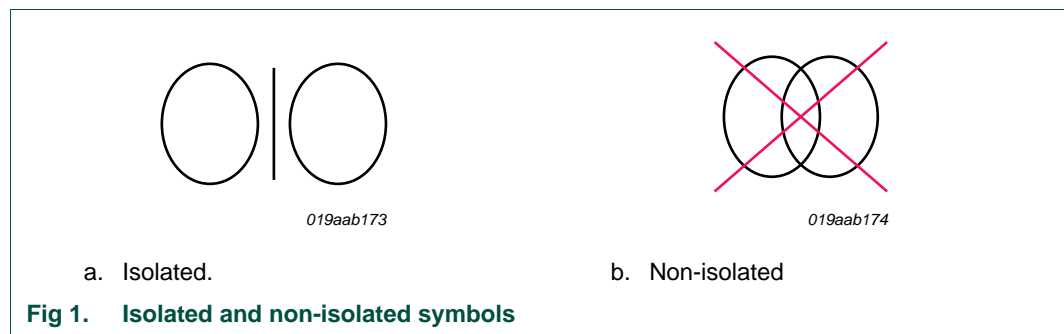

### 3. TEA1723BT features

- Enables low no-load power consumption <30 mW
- Low component count for a cost-effective design
- Advanced control modes for optimal performance
- SMPS controller with integrated power MOSFET switch
- 700 V high-voltage power switch for global mains operation
- Primary sensing at end-of-conduction for accurate output voltage control
- Avoids audible noise in all operation modes
- Jitter function for reduced EMI
- Energy Star 2.0 compliant
- Universal mains input
- Isolated output
- Highly efficient >78 %
- OverTemperature Protection (OTP)

### 4. Technical specification

**Table 1. Input and output specification**

Parameter	Condition	Value	Remark
<b>Input</b>			
Input voltage	-	90 V to 265 V	universal AC mains
Input frequency	-	47 Hz to 63 Hz	
Average power consumption	no-load	24 mW	average of 115 V and 230 V
<b>Output</b>			
Output voltage	-	5 V	-
Maximum output current	-	2.1 A	-
Maximum output power	-	11 W	-

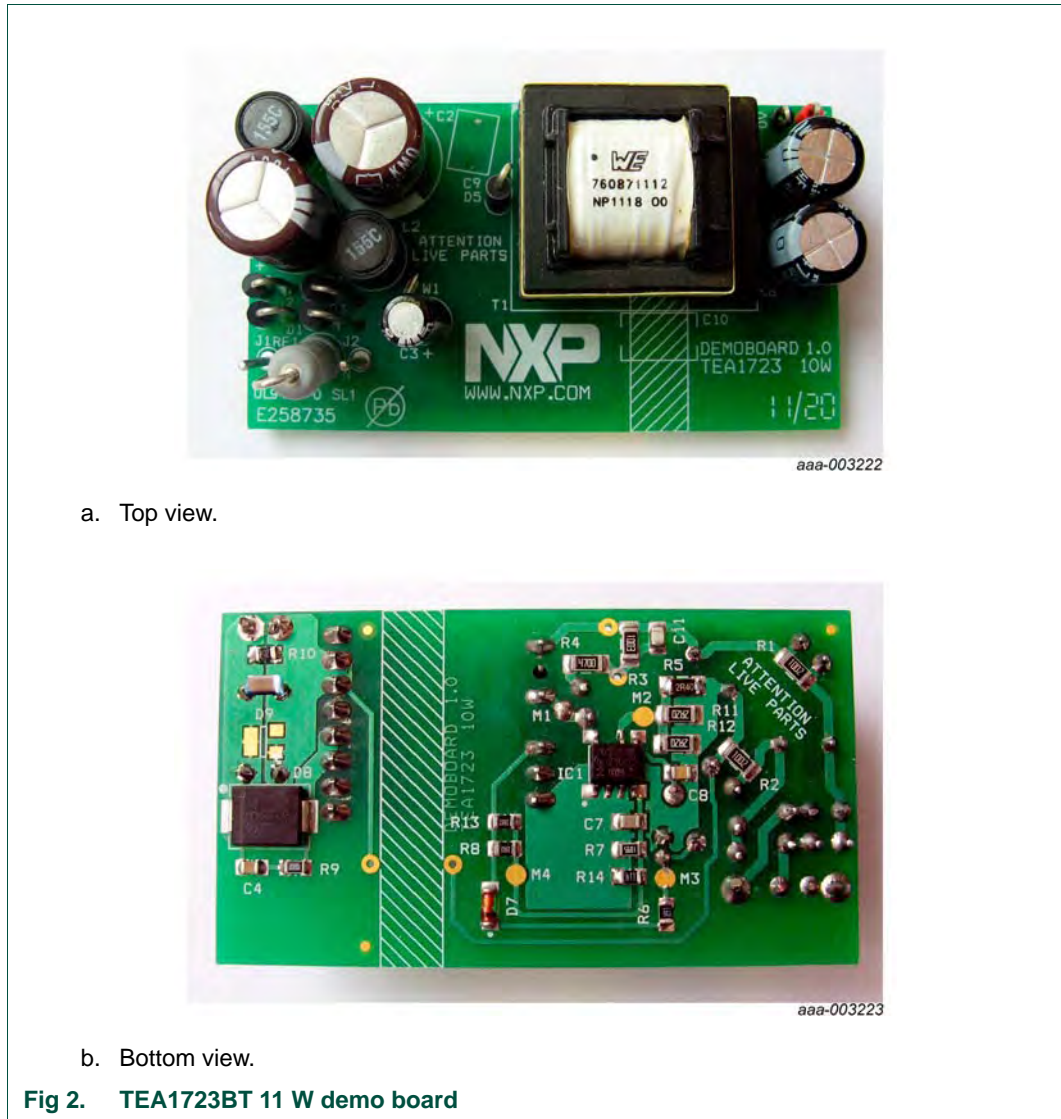

## 5. Performance data

### 5.1 No-load input power consumption

**Test condition:** The no-load input power is measured after a 20 minute warm-up time.

**Table 2. No-load input power consumption**

Condition	Output voltage	Power consumption
115 V at 60 Hz	5 V	23 mW
230 V at 50 Hz	5 V	25.6 mW

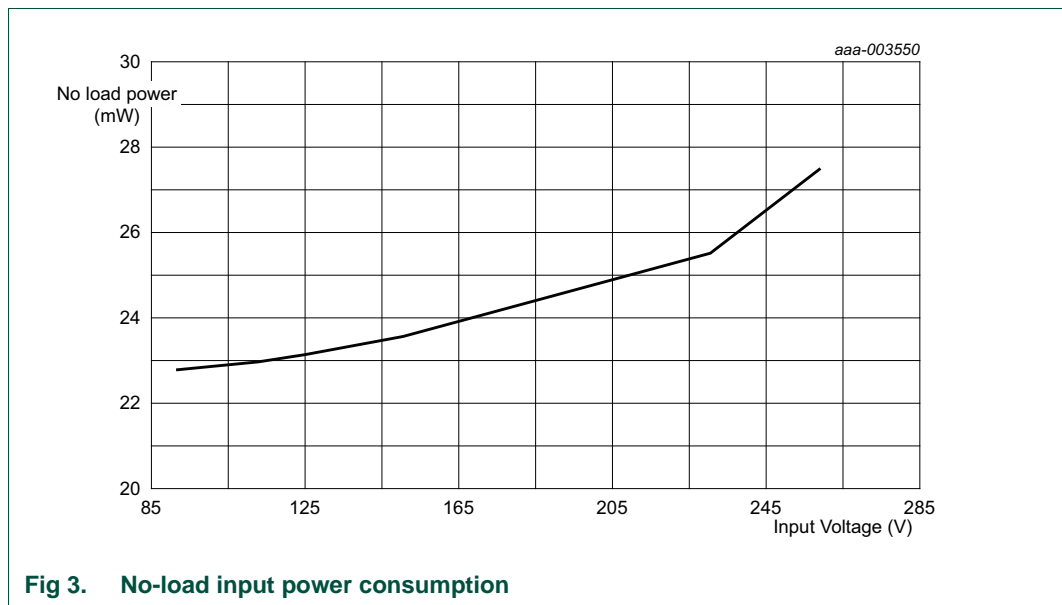

**Fig 3. No-load input power consumption**

### 5.2 Output voltage and efficiency

**Test condition:** The efficiency and VI power characteristics are measured after a 20 minute warm-up time.

Table 3 and Figure 5 show the efficiency figures and VI characteristics measured of the GreenChip SP TEA1723BT demo board.

**Table 3. Efficiency and VI characteristics at 115 V and 230 V**

V <sub>CC</sub>	Parameter	Values
115 V	I <sub>out</sub> (A)	0 0.04 0.1 0.2 0.4 0.6 0.8 1 1.2 1.4 1.6 1.8 2 2.1
	V <sub>out</sub> (V)	5.09 5.06 5.03 4.98 4.96 4.97 4.97 4.99 5.01 5.03 5.04 5.06 5.08 4.97
	P (W)	0.023 0.37 0.74 1.35 2.54 3.83 5.09 6.42 7.72 9.04 10.4 11.7 13.1 13.5
	η (%)	54.7 68 73.8 78.1 77.9 78.1 77.7 77.9 77.9 77.7 77.6 77.6 77.4
	I <sub>out</sub> (A)	0 0.04 0.1 0.2 0.4 0.6 0.8 1 1.2 1.4 1.6 1.8 2 2.1
230 V	V <sub>out</sub> (V)	5.06 5.04 5.03 4.97 4.96 4.96 4.96 4.99 5.01 5.02 5.04 5.05 5.07 5.08
	P (W)	0.0256 0.41 0.84 1.43 2.63 3.82 5.04 6.33 7.6 8.86 10.1 11.4 12.7 13.4
	η (%)	49.2 59.9 69.5 75.4 77.9 78.7 78.8 79.1 79.3 79.6 79.6 79.7 79.8

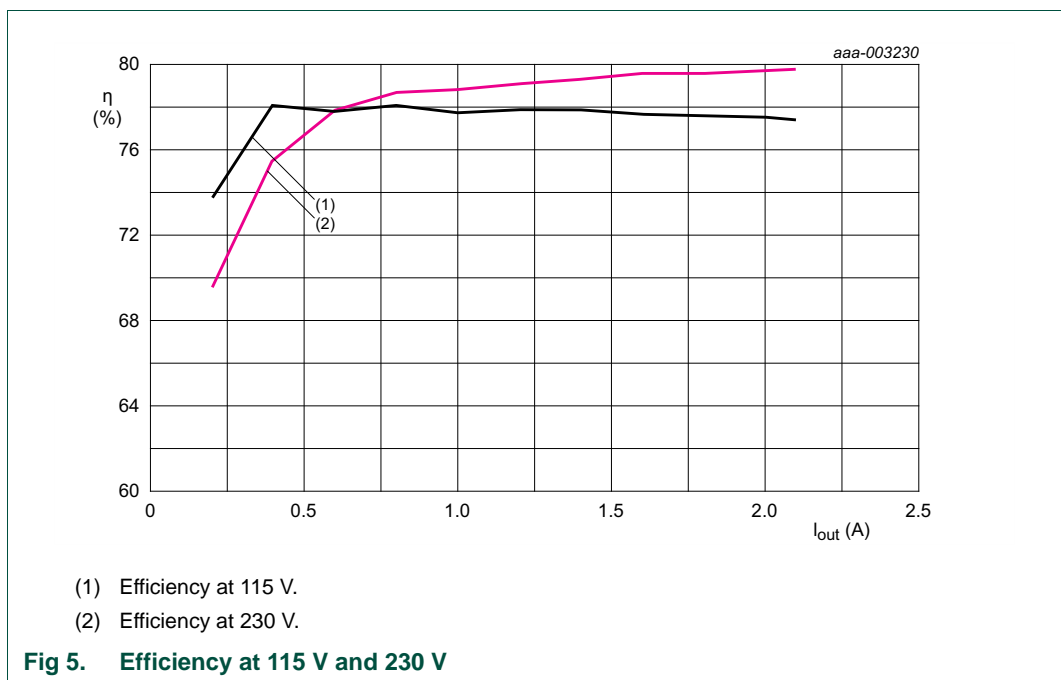
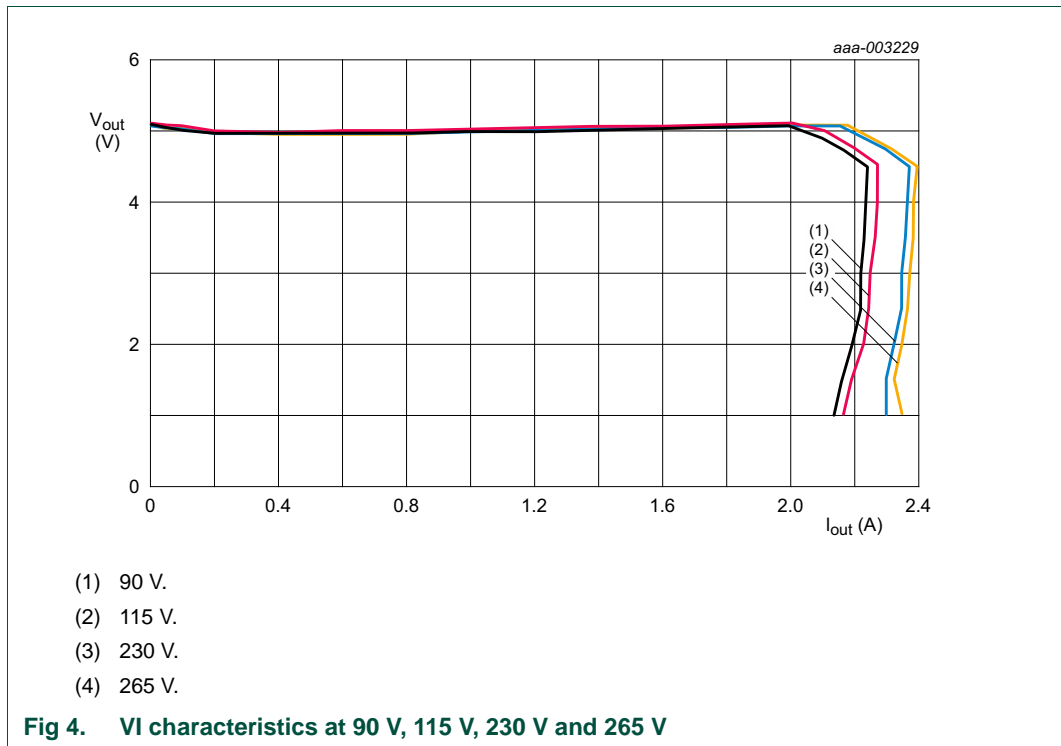

### 5.3 Dynamic loading from 0 A to 0.5 A

**Test condition:** The dynamic loading is tested at a load step of 0 A to 0.5 A. The TEA1723BT detects the load step only after the next switching cycle because of the primary sensing feature.

The load step is measured at  $V_{\text{mains}} = 230 \text{ V}$  and the output capacitors C5/C6 are  $2 \times 470 \mu\text{F}$ . The burst frequency is 885 Hz.

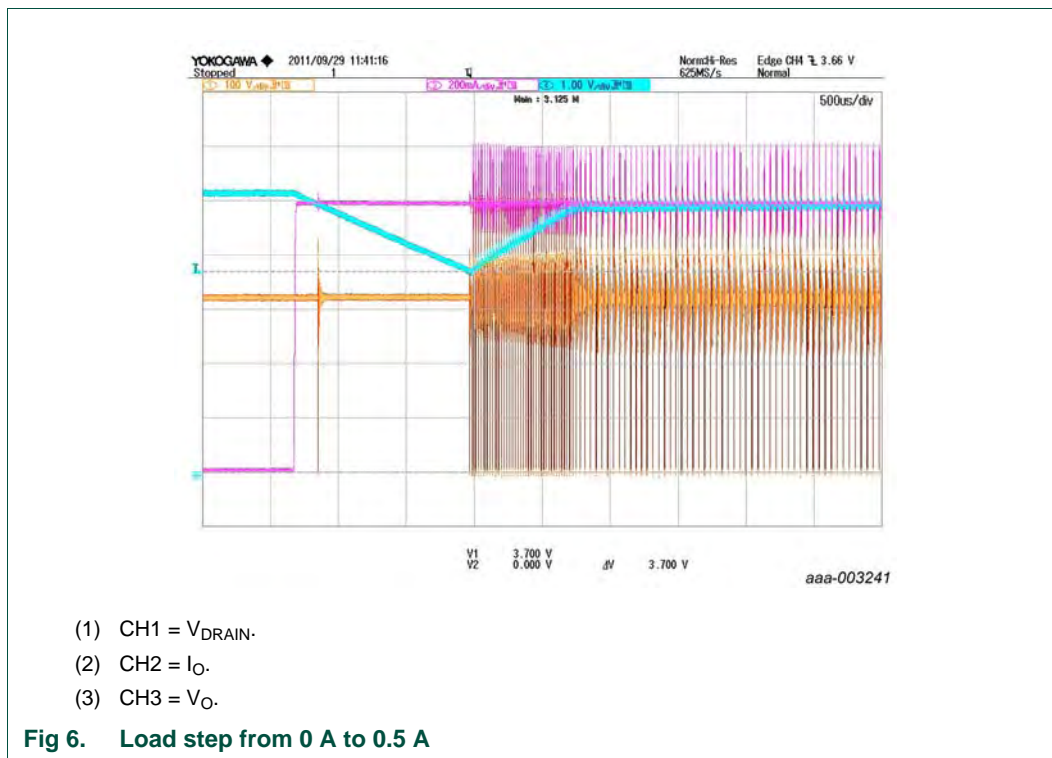

### 5.4 Dynamic loading from 0.5 A to 0 A

**Test condition:** The dynamic loading is tested at a load step of 0 A to 0.5 A. The TEA1723BT detects the load step only after the next switching cycle because of the primary sensing feature.

The load step is measured at  $V_{\text{mains}} = 230 \text{ V}$  and the output capacitors C5/C6 are  $2 \times 470 \mu\text{F}$ .



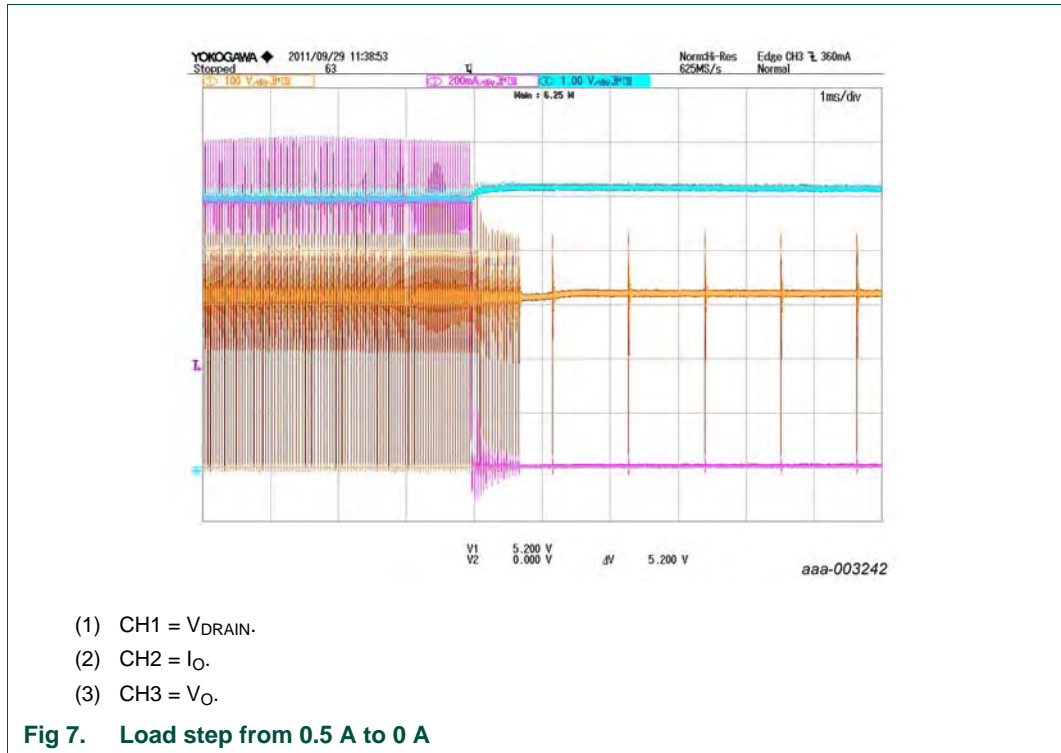

After the load step 0.5 A to 0 A, the output voltage rises to 5.1 V. The transition takes about 1 ms when the controller switches from CV to CVB because of the large electrolytic output capacitors ( $2 \times 470 \mu\text{F}$ ).

### 5.5 Short-circuit of the output

The demo board output can be short-circuited without damaging of any component.

**Test condition:** [Figure 7](#) shows the converter behavior when the output is short-circuited. During a short-circuit of the output, the VCC voltage (CH3) switches between  $V_{CC(\text{startup})} = 17 \text{ V}$  and  $V_{CC(\text{stop})} = 8.5 \text{ V}$  levels. The average output current during converter switching is 1.2 A.

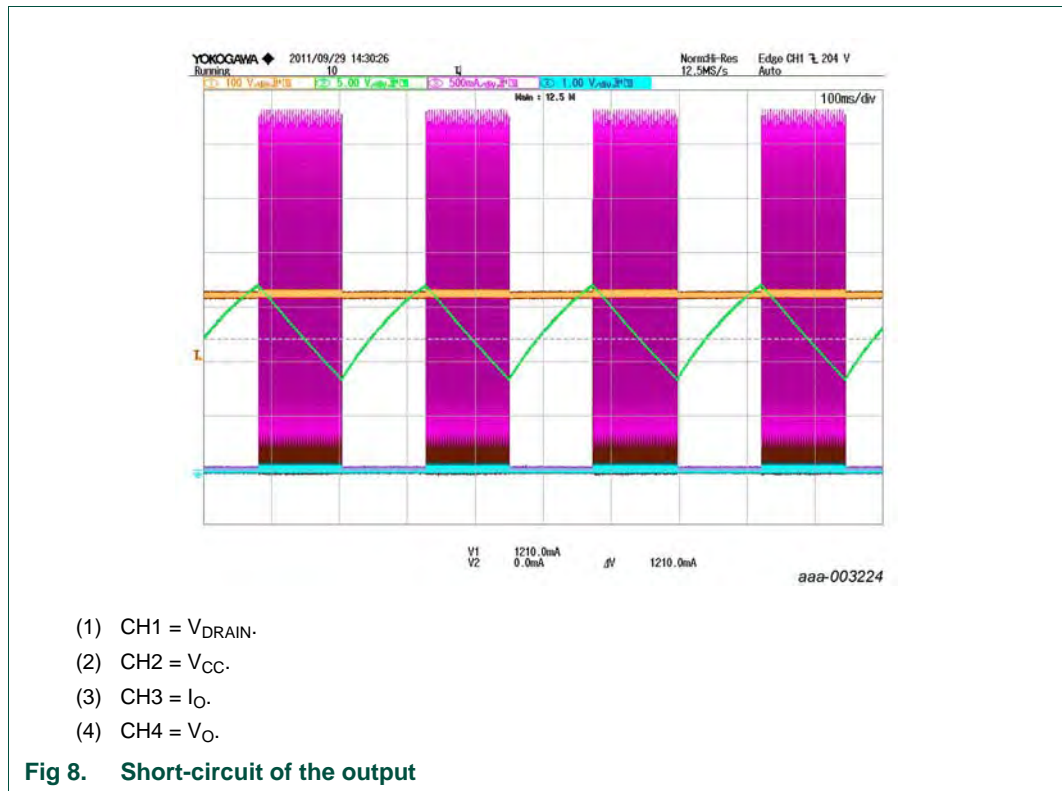

## 5.6 Output voltage ripple performance

**Test condition:** Output voltage ripple is measured using an oscilloscope probe connected to the demo board output. A probe tip was used with a very small GND connection. A 100 nF capacitor between output voltage and GND is used to reduce high frequency noise. The output voltage ripple was measured at full load and at  $V_{mains} = 230$  V.

Figure 8 shows the output voltage ripple at 2.1 A load at 230 V. The output ripple voltage is 240 mV using output capacitors C5/C6 as 470  $\mu$ F.

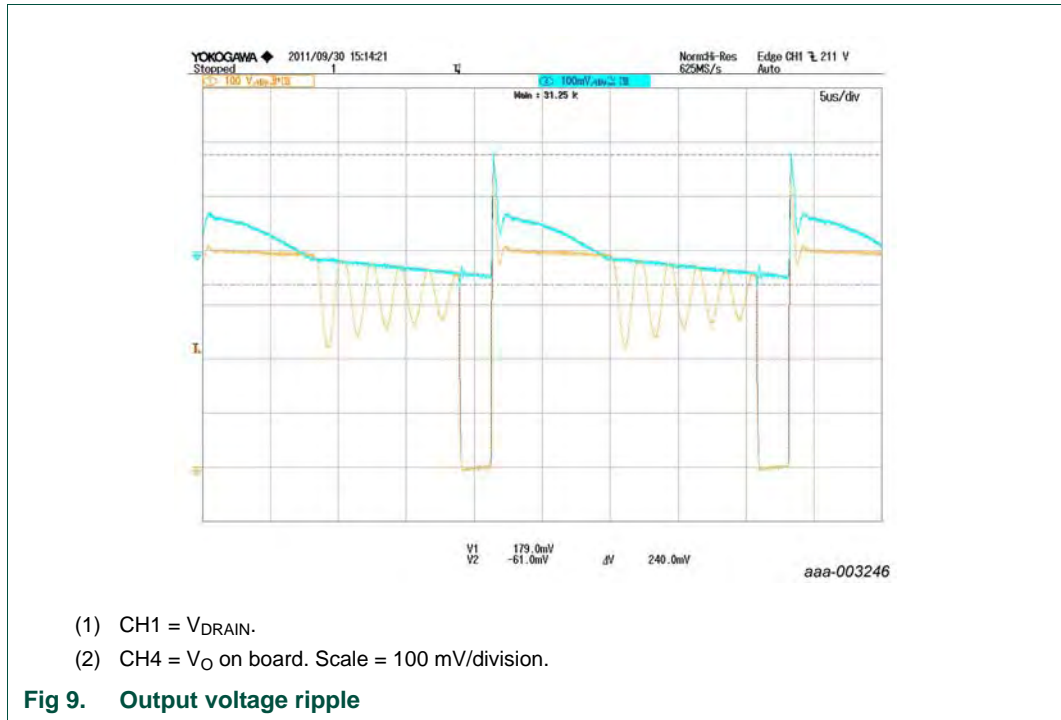

### 5.7 Conducted EMI measurement results

The EMI is measured with the secondary GND connected to the protected mains earth GND. Y-capacitor (C10 = 2.2 nF; 2 kV) is added and only one input coil L1 = 1.5 mH is used. EMI is measured on the neutral phase and on the line phase at  $V_{mains} = 230$  V and at full load. The frequency range is 150 kHz to 30 MHz.

**Remark:** Improved transformer design will enhance TEA1723BT EMI performance significantly.

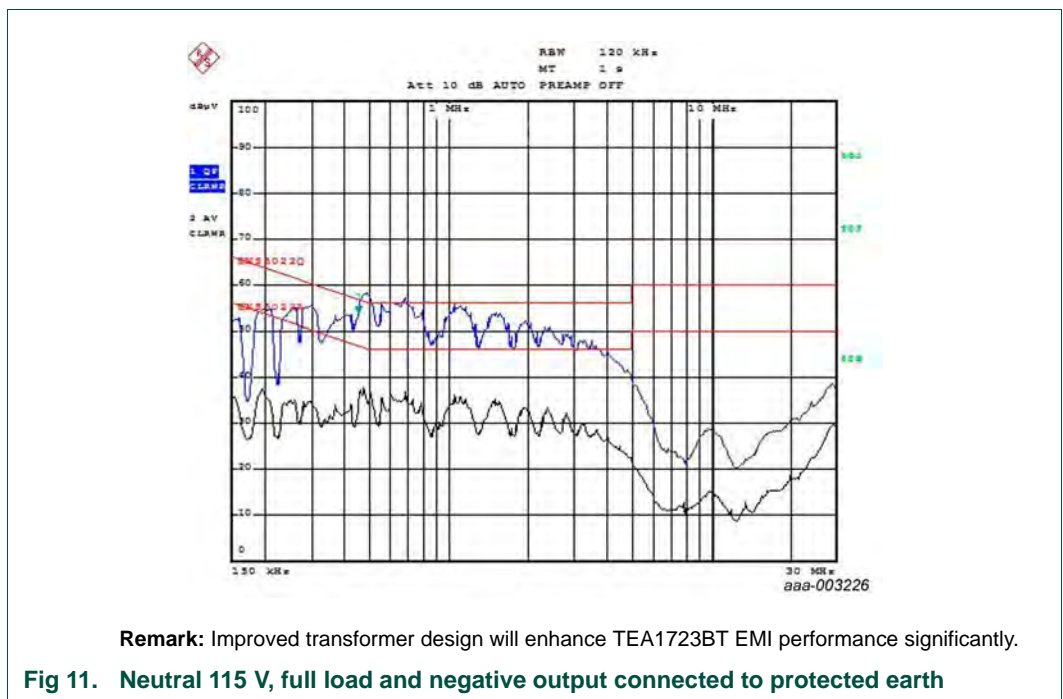
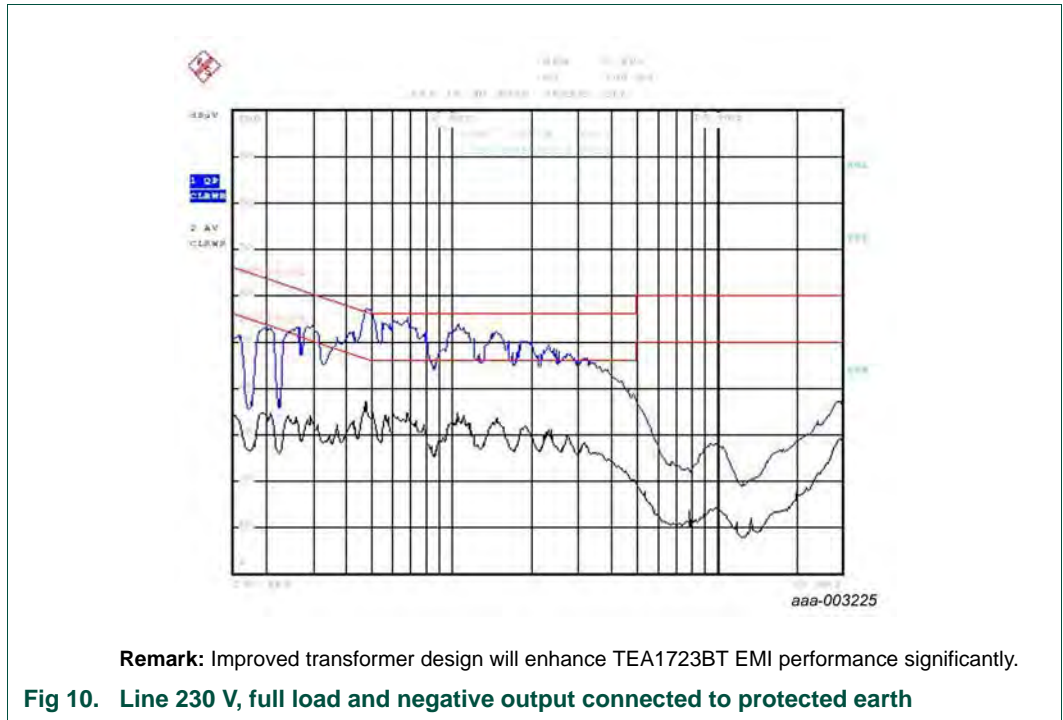

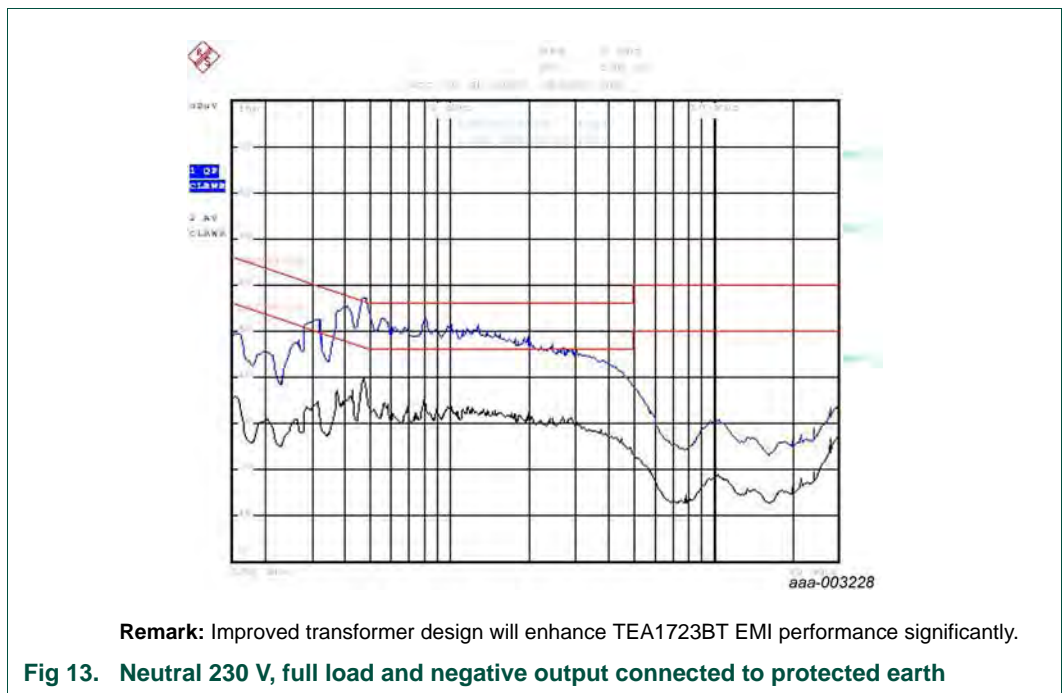
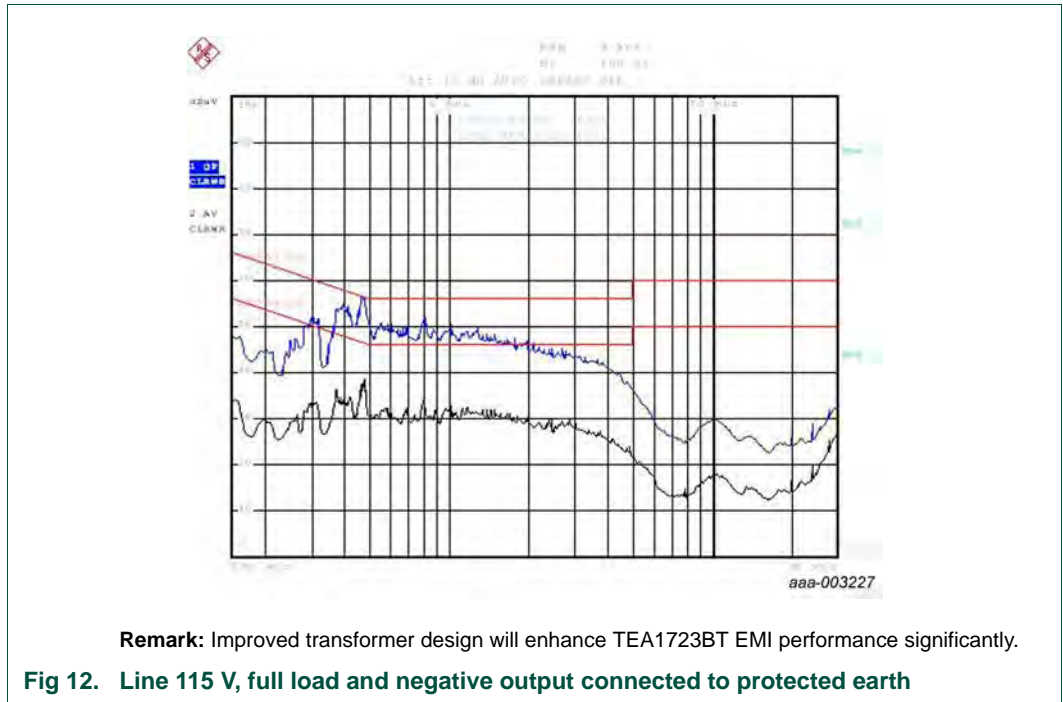

## 6. Schematic and Bill Of Materials (BOM)

### 6.1 TEA1723BT 11 W demo board schematic

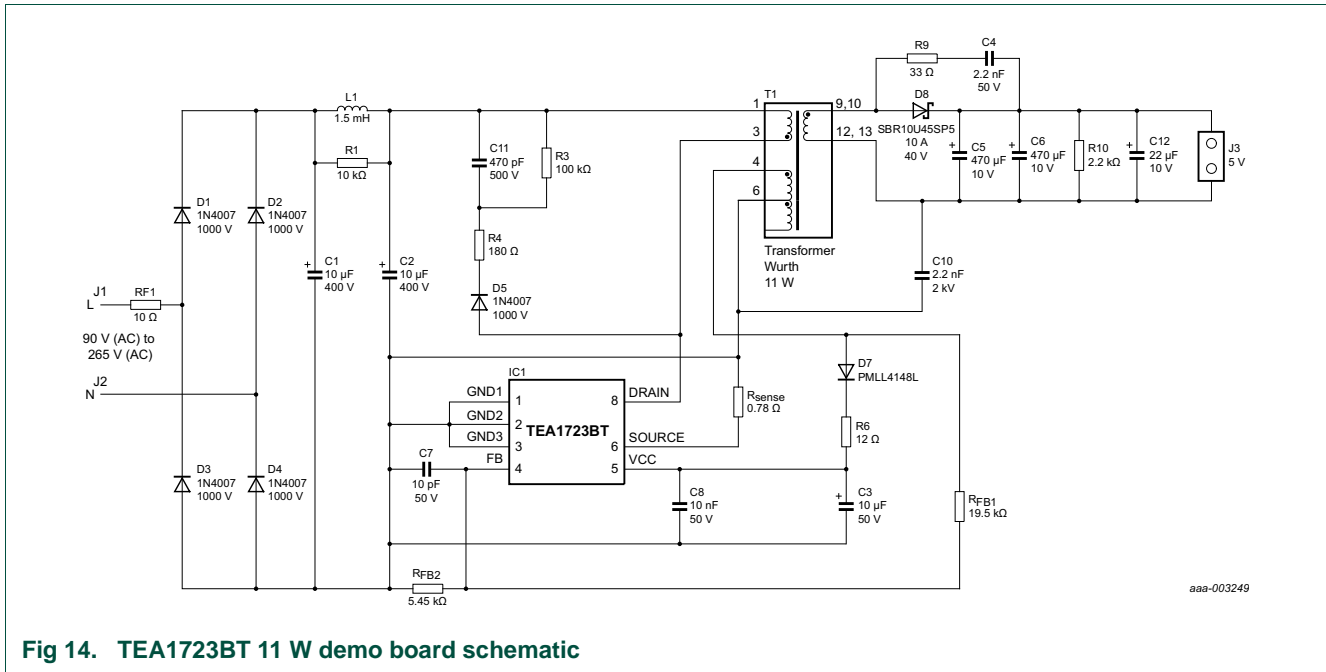

### 6.2 Bill of Materials

Table 4. Bill of materials

Part	Description	Part Number	Manufacturer
C1	capacitor; 10 μF; 400 V; 10 mm × 16 mm	EKMQ401ELL100MJ16S	Chemi-Con
C2	capacitor; 10 μF; 400 V; 10 mm × 16 mm	EKMQ401ELL100MJ16S	Chemi-Con
C3	capacitor; 10 μF; 50 V; 5 mm × 11 mm	ECA1HHG100	Panasonic
C4	capacitor; 2.2 nF; 50 V; 0805	C0805C222K5RACTU	KEMET
C5	capacitor; 470 μF; 10 V; 8 mm × 11.5 mm	UHM1A471MPD	Nichicon
C6	capacitor; 470 μF; 10 V; 8 mm × 11.5 mm	UHM1A471MPD	Nichicon
C7	capacitor; 10 pF; 0805	-	-
C8	capacitor; 10 nF; 0805	X7R	-
C9	not mounted	-	-
C10	capacitor; 2.2 nF; 2 kV	DEBB33D222KA2B	Murata
C11	capacitor; 470 pF; 500 V; 0805	CC0805JRNPOBBN471	Yageo
C12	capacitor; 22 μF; 10 V; 1206	GRM31CR71A226KE15L	Murata
D1	diode; 1N4007; 1 kV; DO-41; 1 A	1N4007	Multicomp
D2	diode; 1N4007; 1 kV; DO-41; 1 A	1N4007	Multicomp
D3	diode; 1N4007; 1 kV; DO-41; 1 A	1N4007	Multicomp
D4	diode; 1N4007; 1 kV; DO-41; 1 A	1N4007	Multicomp
D5	diode; 1N4007; 1 kV; DO-41; 1 A	1N4007	Vishay
D7	diode; PMLL4148; SOD80C glass	PMLL4148L	NXP Semiconductors

Table 4. Bill of materials ...continued

Part	Description	Part Number	Manufacturer
D8	diode; SBR10U45SP5; 45 V; PowerDI5; 10 A	SBR10U45SP5-13	Diodes Inc
IC1	controller; TEA1723BT; S07	TEA1723BT	NXP Semiconductors
L1	inductor; 1.5 mH; DIP	-	Murata
R1	resistor; 10 k $\Omega$ ; 1206	-	-
R3	resistor; 100 k $\Omega$ ; 1206	-	-
R4	resistor; 180 $\Omega$ ; 1206	-	-
R5	resistor; 2.4 $\Omega$ ; 1206	-	-
R6	resistor; 12 $\Omega$ ; 0805	-	-
R7	resistor; 5.6 k $\Omega$ ; 0805	-	-
R8	resistor; 39 k $\Omega$ ; 0805	-	-
R9	resistor; 33 $\Omega$ ; 0805	-	-
R10	resistor; 2.2 k $\Omega$ ; 0805	-	-
R11	resistor; 2.4 $\Omega$ ; 1206	-	-
R12	resistor; 2.2 $\Omega$ ; 1206	-	-
R13	resistor; 39 k $\Omega$ ; 0805	-	-
R14	resistor; 200 k $\Omega$ ; 0805	-	-
RF1	fused resistor; 10 $\Omega$ ; 3 W;	ULW310RJA1	Welwyn Components
T1	transformer; 0.9 mH; EE20/10/6 horizontal	-	Würth Elektronik
W1	jumper wire; DIP	-	-

## 7. Circuit description

The TEA1723BT GreenChip SP demo board consists of a single-phase full-wave rectifier circuit with sections for filtering, switching, output and feedback. The circuit diagram is shown in [Figure 14 on page 14](#) and the component list is shown in [Table 4 on page 14](#).

### 7.1 Rectification section

The bridge diodes BD1 form the single-phase full-wave rectifier. Capacitors C1 and C2 are reservoir capacitors for the rectified input voltage. Resistor RF1 limits inrush current and acts as a fuse. Terminals 1 and 2 connect the input to the AC mains network. Swapping these two wires has no effect on the operation of the converter.

### 7.2 Filtering section

Inductors L1 and L2 in combination with capacitors C1 and C2, form  $\Pi$ -filters to attenuate the conducted differential mode EMI noise.

### 7.3 GreenChip SP section

The TEA1723BT device IC1 contains the power MOSFET switch, oscillator, CV/CC, start-up control and protection functions. Its integrated 700 V MOSFET allows sufficient voltage margins for universal input AC applications, including line surges.

The auxiliary winding on transformer T1 generates the supply voltage and primary sensing information for the TEA1723BT. Diode D7 and capacitor C3 half-wave rectify the voltage. C3 is charged using the current limiter resistor R6. The voltage on C3 is the supply voltage for the VCC pin.

RCD-R clamp (which consists of R4, C9, D5 and R3) limits drain voltage spikes caused by any leakage inductance from the transformer.

### 7.4 Output section

Diode D7 is a Schottky barrier type diode and capacitors C5/C6 rectify the voltage from secondary winding of transformer T1. Using a Schottky diode results in higher efficiency of the demo board.

C5 and C6 must have a sufficiently low ESR to meet the output voltage ripple requirement without adding an LC post filter.

Resistor R9 and capacitor C4 dampen the high frequency ringing and reduce the voltage stress on diode D8. Resistor R10 provides a minimum load to maintain output control in the no-load condition.

### 7.5 Feedback section

The TEA1723BT controls the output using current and frequency control for CV/CC regulation. The auxiliary winding on Transformer T1 senses the output voltage. The FB pin senses the reflected output voltage using feedback resistors  $R_{FB1}$  and  $R_{FB2}$ .



## 8. PCB layout

Figure 16 shows the layout of the PCB.

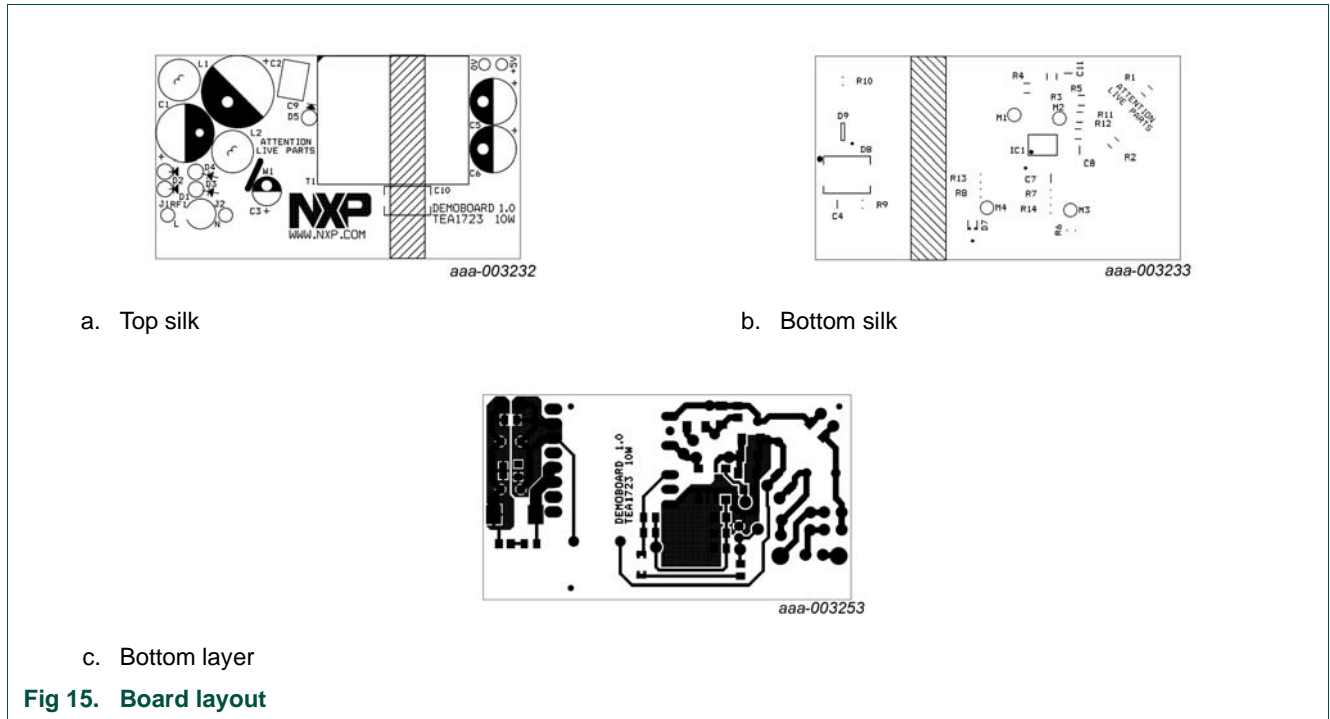

Fig 15. Board layout

## 9. Transformer specifications

### 9.1 Transformer schematic design and winding construction

The transformer used in the TEA1723BT demo board has size EE20 with bobbin EE20/10/6 horizontal, 14-pin. The secondary side of the transformer is connected in parallel in the TEA1723BT demo board, see [Figure 16](#).

- Würth-Midcom 760871112

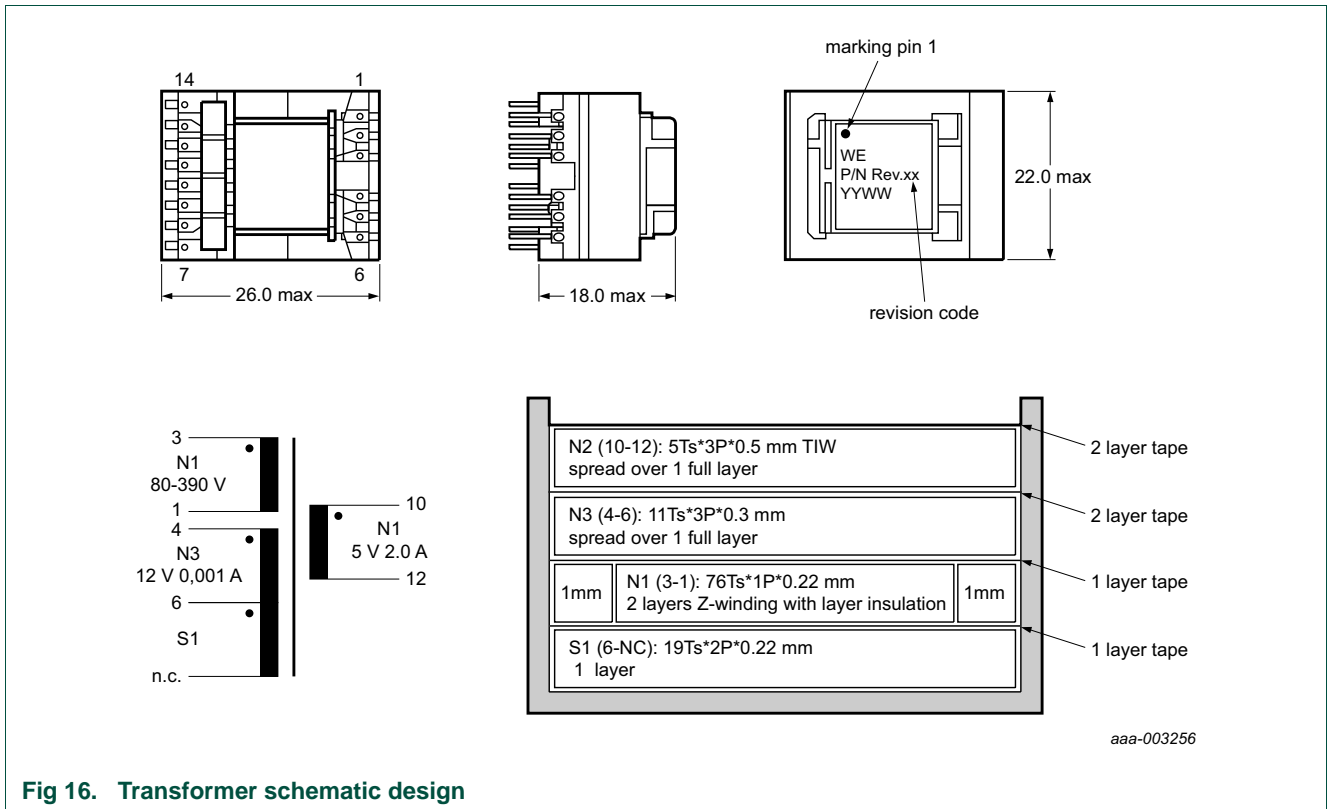

Fig 16. Transformer schematic design

### 9.2 Electrical characteristics

Table 5. Electrical characteristics

Description	Pin	Specifications	Comments
Primary inductance	1 to 3	0.9 mH $\pm$ 10 %	-
Leakage	1 to 3	50 $\mu$ H	secondary side short-circuited

### 9.3 Core, air gap and bobbin

- Core: EE20/10/6 (3C90)
- Size of the air gap depends on the  $A_L$  value of the ungapped core.
- Bobbin: EE20/10/6 horizontal, 14-pin

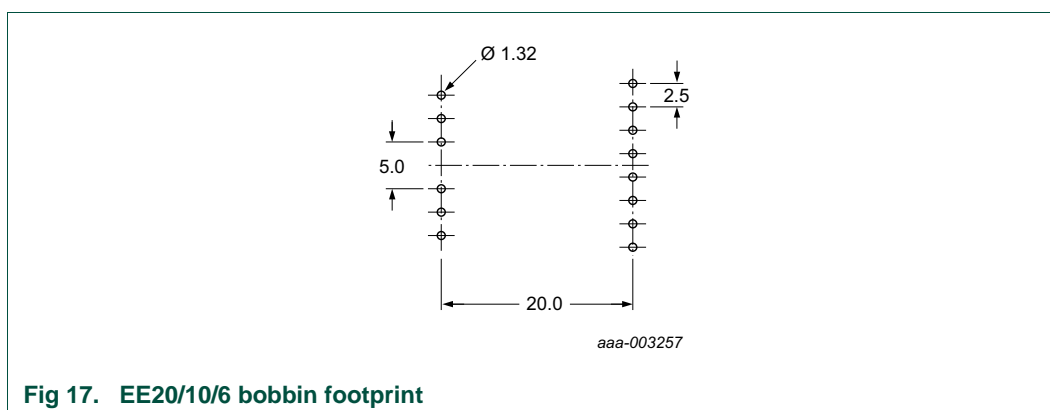

## 10. Attention points

---

When testing the CC mode of the TEA1723BT, use an electronic DC-load in resistive mode, not in current mode.

The current in CC mode has a small fold back characteristic (see [Figure 4](#)). When current mode of an electronic DC-load is used, the output voltage drops immediately to zero when the maximum current is exceeded. Once the output voltage and the input voltage of the DC-load is zero, many DC-loads cannot adjust the current. Using the resistive mode of the electronic DC-load avoids this problem.

**Remark:** This TEA1723BT controller behavior is not incorrect. Only test it in the correct way.

## 11. References

---

- [1] **TEA1721AT/BT/DT/FT** — data sheets: ultra-low standby SMPS controller with integrated power switch
- [2] **TEA1723AT/BT/DT/FT** — data sheets: ultra-low standby SMPS controller with integrated power switch data sheet
- [3] **AN11029** — application note: Using TEA1721/TEA1723 ultra-low standby SMPS controller ICs in white goods applications
- [4] **AN11060** — application note: TEA172X 5 W to 11 W power supply/usb charger
- [5] **UM10520** — TEA1721 Isolated 3-phase universal mains flyback converter demo board user manual
- [6] **UM10521** — TEA1721 isolated universal mains flyback converter demo board user manual
- [7] **UM10522** — TEA1721 non-isolated universal mains buck and buck/boost converter demo board user manual
- [8] **UM10523** — TEA1721 universal mains white goods flyback SMPS demo board user manual

## 12. Legal information

### 12.1 Definitions

**Draft** — The document is a draft version only. The content is still under internal review and subject to formal approval, which may result in modifications or additions. NXP Semiconductors does not give any representations or warranties as to the accuracy or completeness of information included herein and shall have no liability for the consequences of use of such information.

### 12.2 Disclaimers

**Limited warranty and liability** — Information in this document is believed to be accurate and reliable. However, NXP Semiconductors does not give any representations or warranties, expressed or implied, as to the accuracy or completeness of such information and shall have no liability for the consequences of use of such information. NXP Semiconductors takes no responsibility for the content in this document if provided by an information source outside of NXP Semiconductors.

In no event shall NXP Semiconductors be liable for any indirect, incidental, punitive, special or consequential damages (including - without limitation - lost profits, lost savings, business interruption, costs related to the removal or replacement of any products or rework charges) whether or not such damages are based on tort (including negligence), warranty, breach of contract or any other legal theory.

Notwithstanding any damages that customer might incur for any reason whatsoever, NXP Semiconductors' aggregate and cumulative liability towards customer for the products described herein shall be limited in accordance with the *Terms and conditions of commercial sale* of NXP Semiconductors.

**Right to make changes** — NXP Semiconductors reserves the right to make changes to information published in this document, including without limitation specifications and product descriptions, at any time and without notice. This document supersedes and replaces all information supplied prior to the publication hereof.

**Suitability for use** — NXP Semiconductors products are not designed, authorized or warranted to be suitable for use in life support, life-critical or safety-critical systems or equipment, nor in applications where failure or malfunction of an NXP Semiconductors product can reasonably be expected to result in personal injury, death or severe property or environmental damage. NXP Semiconductors and its suppliers accept no liability for inclusion and/or use of NXP Semiconductors products in such equipment or applications and therefore such inclusion and/or use is at the customer's own risk.

**Applications** — Applications that are described herein for any of these products are for illustrative purposes only. NXP Semiconductors makes no representation or warranty that such applications will be suitable for the specified use without further testing or modification.

Customers are responsible for the design and operation of their applications and products using NXP Semiconductors products, and NXP Semiconductors accepts no liability for any assistance with applications or customer product design. It is customer's sole responsibility to determine whether the NXP Semiconductors product is suitable and fit for the customer's applications and products planned, as well as for the planned application and use of customer's third party customer(s). Customers should provide appropriate design and operating safeguards to minimize the risks associated with their applications and products.

NXP Semiconductors does not accept any liability related to any default, damage, costs or problem which is based on any weakness or default in the customer's applications or products, or the application or use by customer's third party customer(s). Customer is responsible for doing all necessary testing for the customer's applications and products using NXP Semiconductors products in order to avoid a default of the applications and the products or of the application or use by customer's third party customer(s). NXP does not accept any liability in this respect.

**Export control** — This document as well as the item(s) described herein may be subject to export control regulations. Export might require a prior authorization from competent authorities.

**Evaluation products** — This product is provided on an "as is" and "with all faults" basis for evaluation purposes only. NXP Semiconductors, its affiliates and their suppliers expressly disclaim all warranties, whether express, implied or statutory, including but not limited to the implied warranties of non-infringement, merchantability and fitness for a particular purpose. The entire risk as to the quality, or arising out of the use or performance, of this product remains with customer.

In no event shall NXP Semiconductors, its affiliates or their suppliers be liable to customer for any special, indirect, consequential, punitive or incidental damages (including without limitation damages for loss of business, business interruption, loss of use, loss of data or information, and the like) arising out of the use of or inability to use the product, whether or not based on tort (including negligence), strict liability, breach of contract, breach of warranty or any other theory, even if advised of the possibility of such damages.

Notwithstanding any damages that customer might incur for any reason whatsoever (including without limitation, all damages referenced above and all direct or general damages), the entire liability of NXP Semiconductors, its affiliates and their suppliers and customer's exclusive remedy for all of the foregoing shall be limited to actual damages incurred by customer based on reasonable reliance up to the greater of the amount actually paid by customer for the product or five dollars (US\$5.00). The foregoing limitations, exclusions and disclaimers shall apply to the maximum extent permitted by applicable law, even if any remedy fails of its essential purpose.

### 12.3 Trademarks

Notice: All referenced brands, product names, service names and trademarks are the property of their respective owners.

**GreenChip** — is a trademark of NXP B.V.

### 13. Contents

<b>1</b>	<b>Introduction</b> .....	<b>3</b>
<b>2</b>	<b>Safety Warning</b> .....	<b>3</b>
<b>3</b>	<b>TEA1723BT features</b> .....	<b>4</b>
<b>4</b>	<b>Technical specification</b> .....	<b>4</b>
<b>5</b>	<b>Performance data</b> .....	<b>6</b>
5.1	No-load input power consumption .....	6
5.2	Output voltage and efficiency .....	6
5.3	Dynamic loading from 0 A to 0.5 A .....	7
5.4	Dynamic loading from 0.5 A to 0 A .....	8
5.5	Short-circuit of the output .....	9
5.6	Output voltage ripple performance .....	10
5.7	Conducted EMI measurement results .....	11
<b>6</b>	<b>Schematic and Bill Of Materials (BOM)</b> .....	<b>14</b>
6.1	TEA1723BT 11 W demo board schematic ...	14
6.2	Bill of Materials .....	14
<b>7</b>	<b>Circuit description</b> .....	<b>16</b>
7.1	Rectification section .....	16
7.2	Filtering section .....	16
7.3	GreenChip SP section .....	16
7.4	Output section .....	16
7.5	Feedback section .....	16
<b>8</b>	<b>PCB layout</b> .....	<b>17</b>
<b>9</b>	<b>Transformer specifications</b> .....	<b>18</b>
9.1	Transformer schematic design and winding construction .....	18
9.2	Electrical characteristics .....	18
9.3	Core, air gap and bobbin .....	19
<b>10</b>	<b>Attention points</b> .....	<b>20</b>
<b>11</b>	<b>References</b> .....	<b>21</b>
<b>12</b>	<b>Legal information</b> .....	<b>22</b>
12.1	Definitions .....	22
12.2	Disclaimers .....	22
12.3	Trademarks .....	22
<b>13</b>	<b>Contents</b> .....	<b>23</b>

Please be aware that important notices concerning this document and the product(s) described herein, have been included in section 'Legal information'.

© NXP B.V. 2012.

All rights reserved.

For more information, please visit: <http://www.nxp.com>

For sales office addresses, please send an email to: [salesaddresses@nxp.com](mailto:salesaddresses@nxp.com)

Date of release: 21 May 2012

Document identifier: UM10533