



UM10548

TEA1721FT 5 W GreenChip SP small-size demo board

Rev. 1 — 21 June 2012

User manual

Document information

Info	Content
Keywords	TEA1721FT, ultra-low standby power, constant output voltage, constant output current, primary sensing, integrated high-voltage switch, integrated high-voltage start-up, USB charger, 5 V/1 A supply
Abstract	This user manual describes a 5 W Constant Voltage (CV) or Constant Current (CC) universal input power supply for mobile phone adapters and chargers. This demo board is based on the GreenChip SP TEA1721FT. GreenChip SP TEA1721FT enables only 5 % output voltage tolerance at dynamic load behavior with low no-load power dissipation <40 mW. The TEA1721FT design ensures a low external component count for cost-effective applications. In addition, the TEA1721FT provides advanced control modes for optimal performance. The TEA1721FT integrates the 700 V power MOSFET switch and SMPS controller.



Revision history

Rev	Date	Description
v.1	20120621	first issue

Contact information

For more information, please visit: <http://www.nxp.com>

For sales office addresses, please send an email to: salesaddresses@nxp.com

1. Introduction

WARNING

Lethal voltage and fire ignition hazard

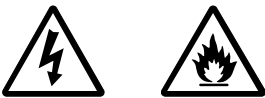

The non-insulated high voltages that are present when operating this product, constitute a risk of electric shock, personal injury, death and/or ignition of fire.

This product is intended for evaluation purposes only. It shall be operated in a designated test area by personnel qualified according to local requirements and labor laws to work with non-insulated mains voltages and high-voltage circuits. This product shall never be operated unattended.

This User Manual describes a 5 W Constant Voltage (CV) or Constant Current (CC) universal input power supply for mobile phone adapters and chargers. This demo board is based on the TEA1721FT GreenChip SP.

The TEA1721FT GreenChip SP provides ultra-low <40 mW, no-load power dissipation without using additional external components. Designs are cost-effective using the TEA1721FT GreenChip SP because only a few external components are needed in a typical application. In addition, the TEA1721FT provides advanced control modes for optimal performance. The TEA1721FT integrates the 700 V power MOSFET switch and SMPS controller.

Remark: All voltages are in V (AC) unless otherwise stated

2. Safety Warning

The complete demo board application is AC mains voltage powered. Avoid touching the board when power is applied. An isolated housing is obligatory when used in uncontrolled, non-laboratory environments. Always provide galvanic isolation of the mains phase using a variable transformer. The following symbols identify isolated and non-isolated devices.

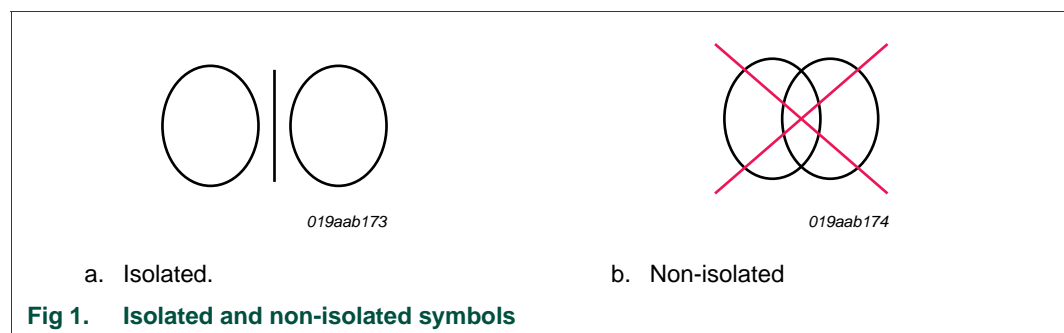

3. Features

- Has only 5 % output voltage tolerance at dynamic load behavior
- Enables low no-load power dissipation <40 mW
- Low component count for a cost-effective design
- Advanced control modes for optimal performance
- SMPS controller with integrated power MOSFET switch
- 700 V high-voltage power switch for global mains operation
- Primary sensing at end-of-conduction for accurate output voltage control
- Avoids audible noise in all operation modes
- Compensation of cable impedance included
- Jitter function for reduced EMI
- USB battery charging and Energy Star compliant
- Universal mains input
- Isolated output
- Highly efficient: >77 %
- OverTemperature Protection (OTP)

4. Technical specification

Table 1. Input and output specification

Parameter	Condition	Value	Remark
Input			
Input voltage	-	90 V to 265 V	universal AC mains
Input frequency	-	47 Hz to 63 Hz	
Average power dissipation	no-load	31 mW	average of 115 V and 230 V
Output			
Output voltage	-	5.0 V	-
Maximum output current	-	1.0 A	-
Maximum output power	-	5.0 W	-

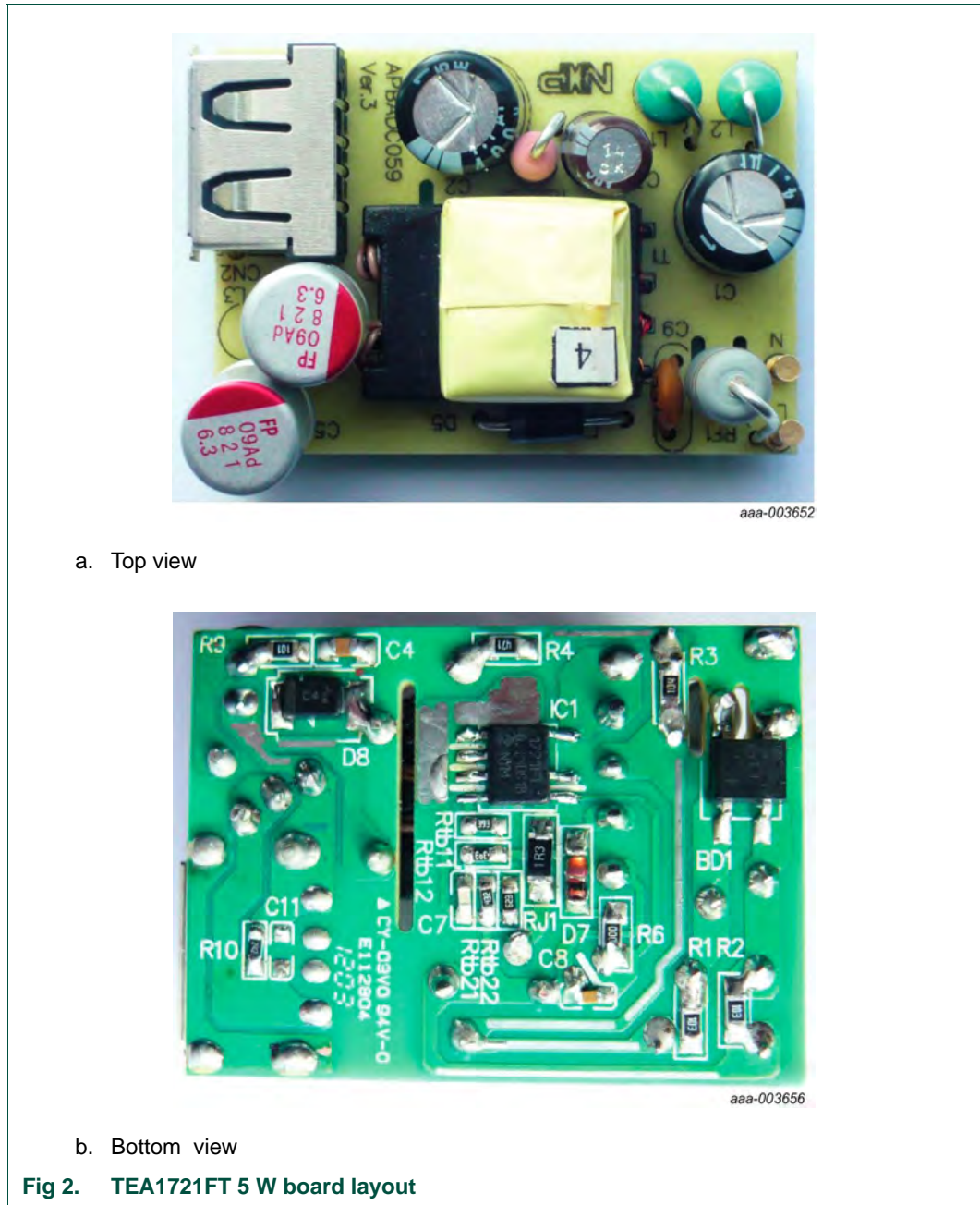

5. performance data

5.1 No-load Input power dissipation

Table 2. No-load Input power dissipation^[1]

Output voltage	Conditions	Power dissipation	Unit
5.0 V	115 V; 60 Hz	28.7	mW
5.0 V	230 V; 50 Hz	33.2	mW

[1] The no-load input power has been measured after 20 minutes warm-up time.

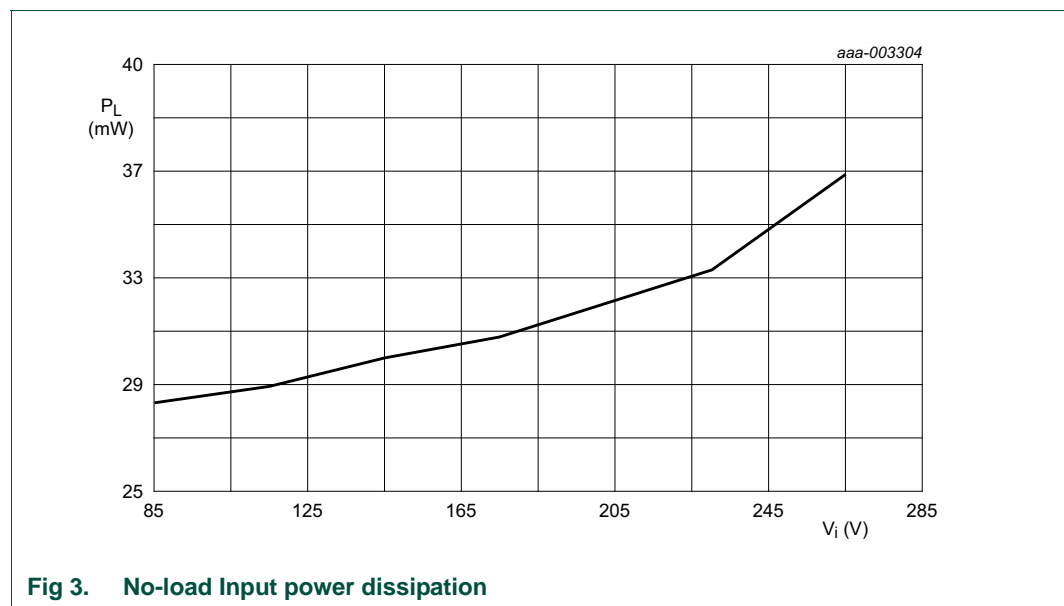

Fig 3. No-load Input power dissipation

5.2 Output voltage and efficiency performance data

Table 3 and Figure 4 show the measured efficiency figures and VI characteristics of the GreenChip SP TEA1721FT demo board. The efficiency and VI characteristics have been measured after 20 minutes warm-up time.

Table 3. Efficiency and VI characteristics^[1]

V _{CC}	Parameter	Values													
115 V	output current (A)	0.00	0.02	0.03	0.05	0.1	0.2	0.3	0.4	0.5	0.6	0.7	0.8	0.9	1.0
	output voltage (V)	5.10	5.08	5.05	5.04	5.00	4.99	4.99	5.00	5.01	5.02	5.03	5.05	5.06	5.07
	input power (W)	0.0136	0.17	0.23	0.35	0.65	1.27	1.90	2.53	3.18	3.83	4.50	5.15	5.80	6.48
	efficiency (%)	-	-	-	-	75.2	78.1	78.4	78.5	78.4	78.4	78.3	78.3	78.3	78.3
230 V	output current (A)	0.00	0.02	0.03	0.05	0.1	0.2	0.3	0.4	0.5	0.6	0.7	0.8	0.9	1.0
	output voltage (V)	5.09	5.09	5.08	5.05	5.01	4.99	4.99	4.99	5.01	5.02	5.03	5.04	5.05	5.06
	input power (W)	0.0163	0.18	0.29	0.43	0.73	1.34	1.95	2.55	3.20	3.84	4.48	5.15	5.78	6.44
	efficiency (%)	-	-	-	-	67.0	74.2	76.5	77.8	78.2	78.2	78.3	78.3	78.4	78.4

[1] The no-load input power has been measured after 20 minutes warm-up time.

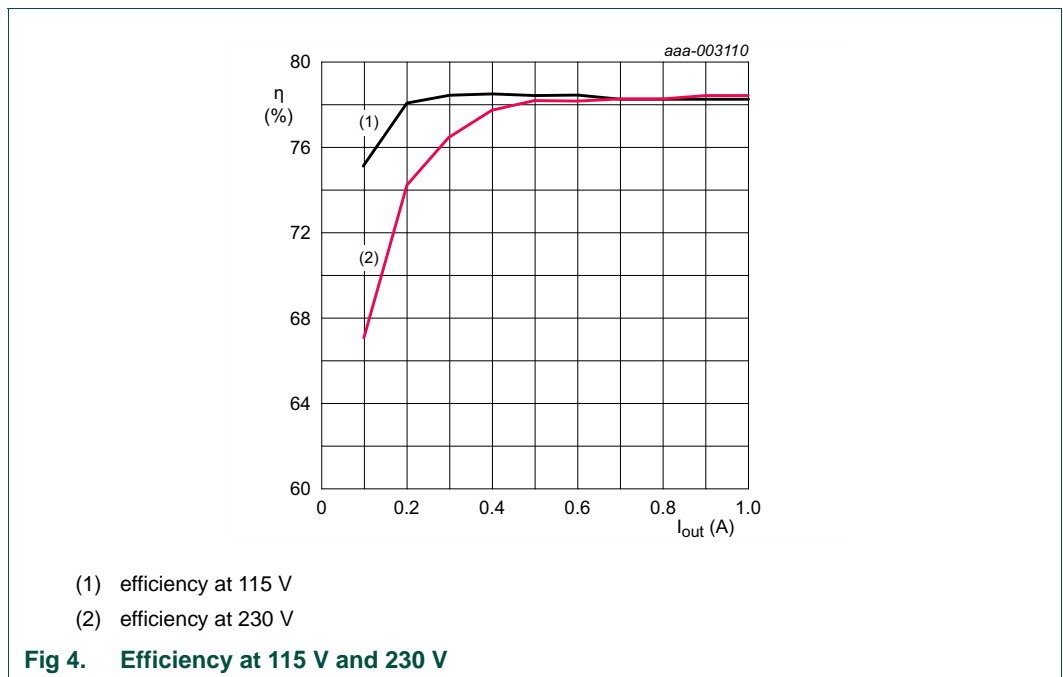

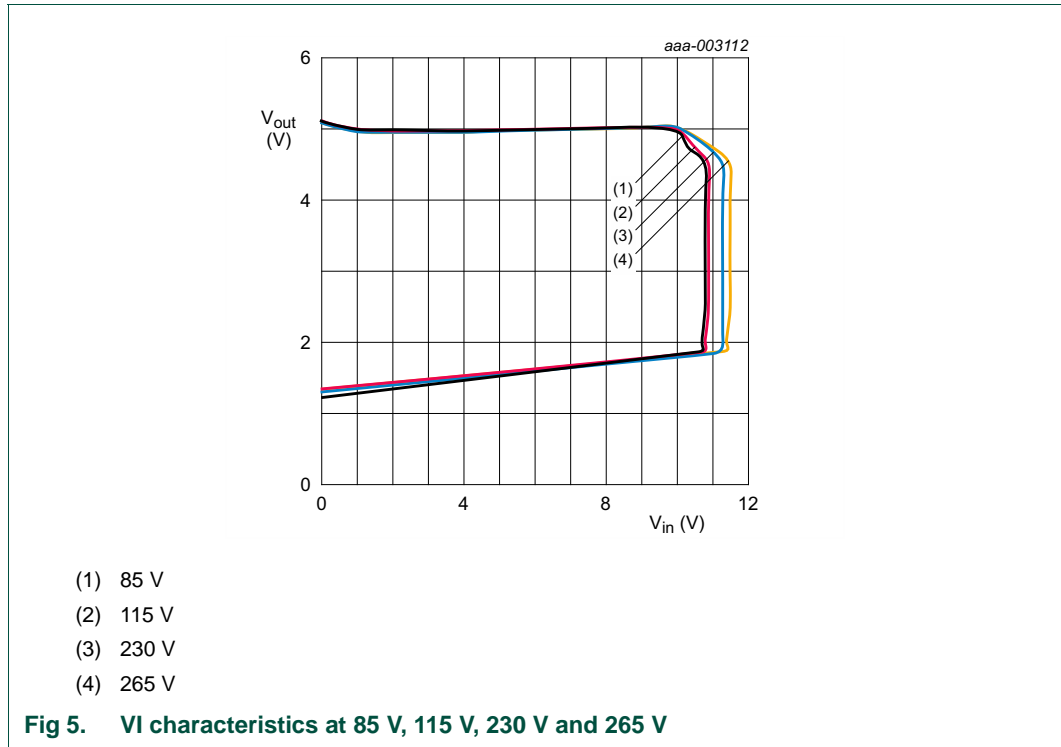

5.3 Dynamic loading from 0 A to 0.5 A

The dynamic loading was tested according to the USB-charger specification 1.1. At a load step of 0 A to 0.5 A, the output voltage must stay above 4.1 V. Due to primary sensing, the TEA1721FT detects the load step only after the next switching cycle. The load step is measured at $V_{\text{mains}} = 230 \text{ V}$. The output capacitors (C5 and C6) are $820 \mu\text{F}/6.3 \text{ V}$ (see [Table 4](#)). The burst frequency is 1750 Hz.

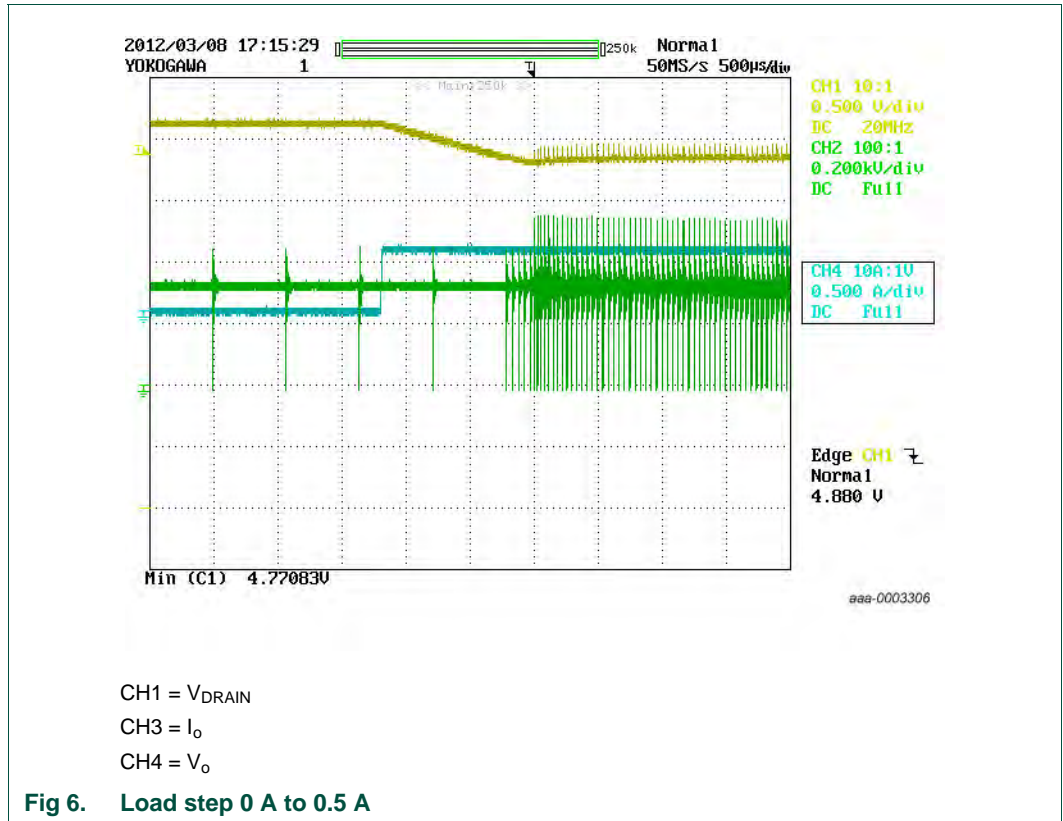

In the worst case (see [Figure 6](#)), the output voltage drops to 4.77 V which fulfills the 5 % dynamic load requirement.

5.4 Dynamic loading from 0.5 A to 0 A

The dynamic loading was tested according to the USB-charger specification 1.1. At a load step of 0.5 A to 0 A, the output voltage must stay below 6.0 V. Due to primary sensing, the TEA1721FT detects the load step only after the next switching cycle. The load step is measured at $V_{mains} = 230$ V. The output capacitors (C5 and C6) are 820 μ F/6.3 V (see [Table 4](#)).

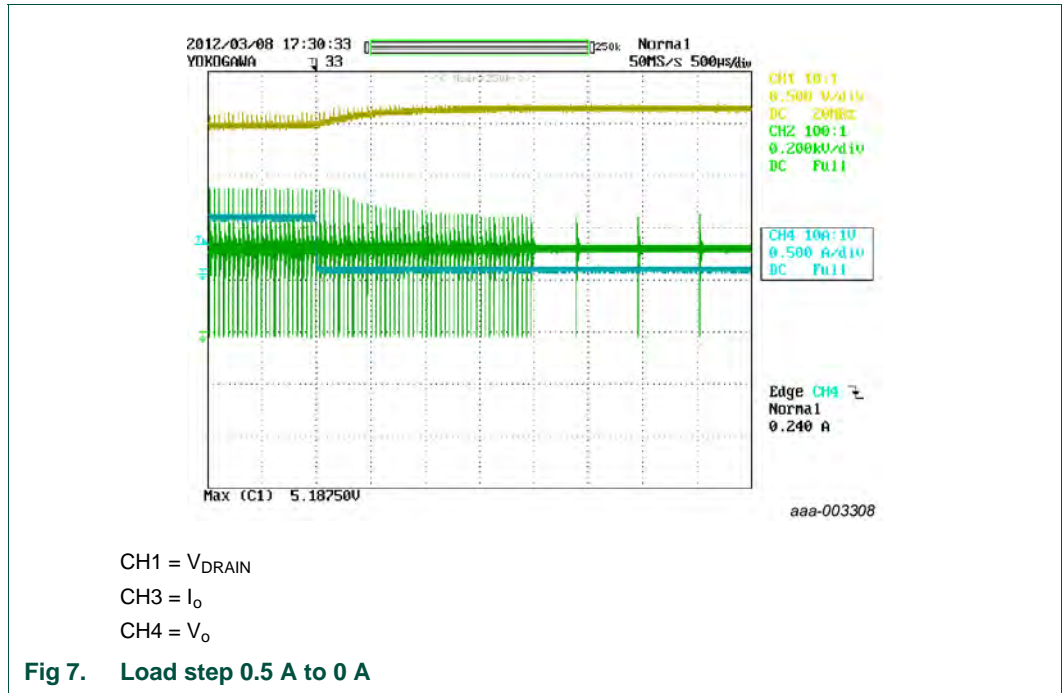

After the load step from 0.5 A to 0 A, the output voltage rises from 5.0 V to 5.19 V. Due to the large electrolytic output capacitors (820 μ F), the transition takes about 2 ms and the controller switches from CV to CVB.

5.5 Short-circuit of the output

The output of the demo board can be short-circuited without damaging of any component.

Figure 8 shows the behavior of the converter when the output is short-circuited. During short-circuit of the output, the V_{CC} voltage (CH3) switches between $V_{CC(\text{startup})}$ (17 V) and $V_{CC(\text{stop})}$ (8 V) level. The average output current during switching of the converter is 0.5 A.

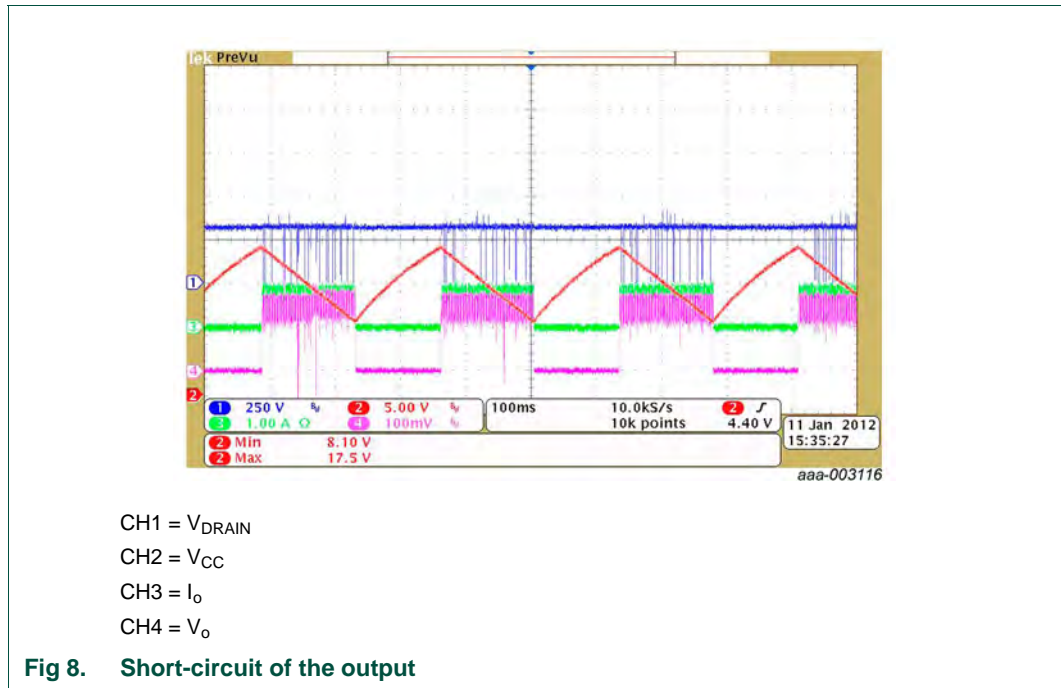

5.6 Output voltage ripple performance

The output voltage ripple was measured with an oscilloscope probe connected to the output of the demo board. A probe tip was used with a very small GND connection. A 100 nF capacitor between output voltage and GND was used to reduce high frequency noise. The output voltage ripple was measured at full load and at V_{mains} of 230 V.

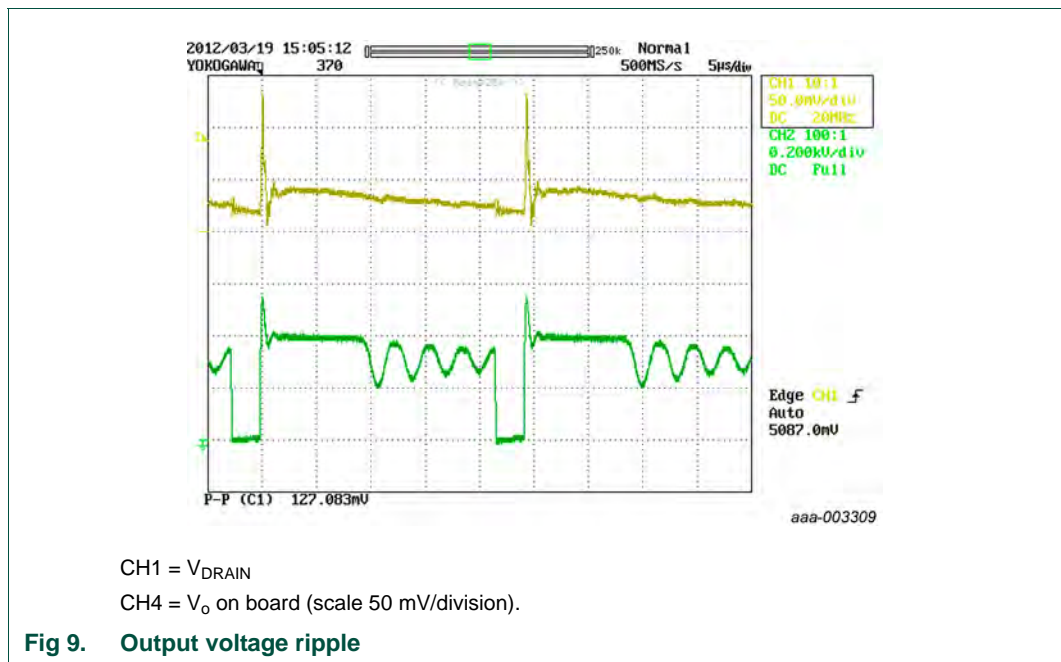

Figure 9 shows the output voltage ripple at a 1 A load at 230 V. The output ripple voltage is 127 mV using output capacitors C5 and C6 (820 μ F/6.3 V Nichicon RL80J821MDN1KX).

5.7 Conducted EMI measurements results

The conducted EMI is measured with the secondary GND connected to the protected mains earth GND. No y-cap between primary side and secondary side is used. EMI is measured on the neutral phase and on the line phase at $V_{\text{mains}} = 230 \text{ V}$ and at full load. The frequency range is 150 kHz to 30 MHz.



Fig 10. Neutral 230 V

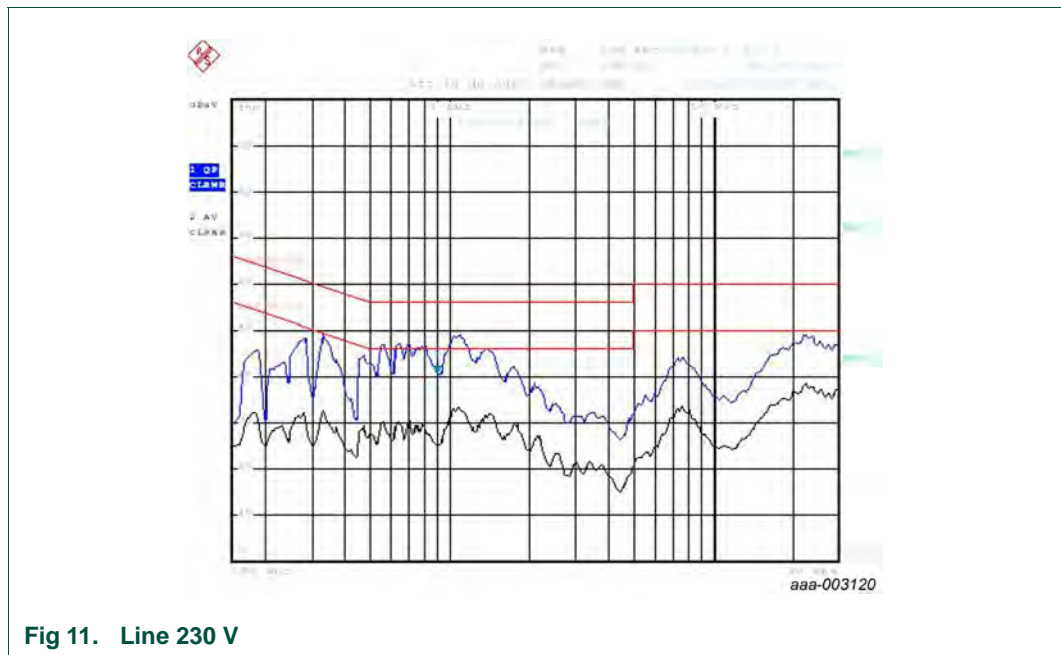

Fig 11. Line 230 V

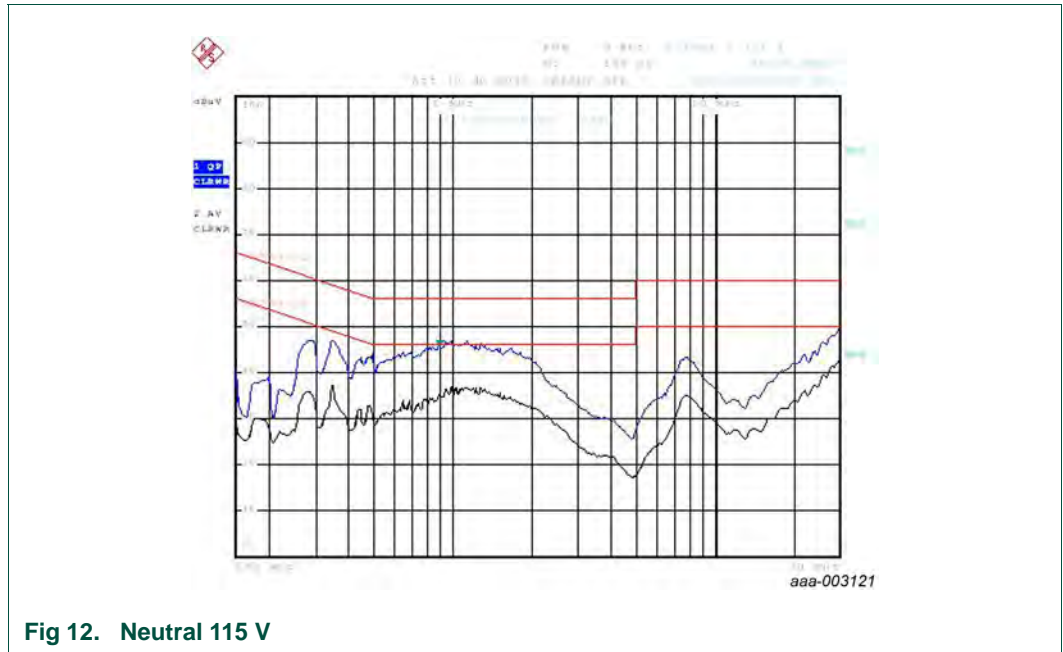

Fig 12. Neutral 115 V

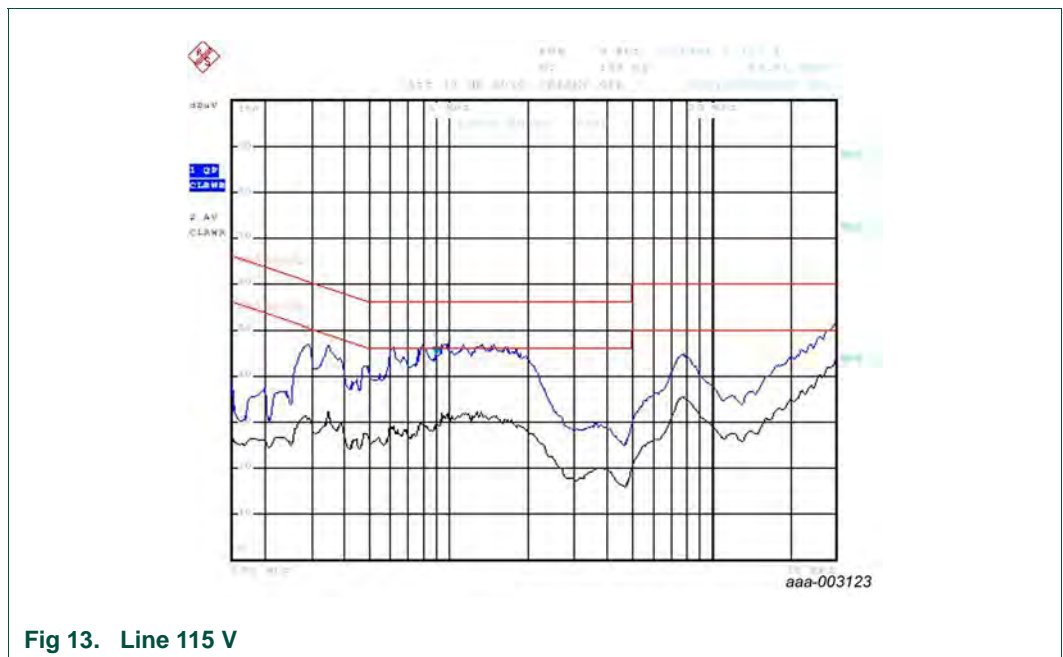

Fig 13. Line 115 V

6. Schematic and Bill Of Material (BOM)

6.1 Small-size 5 W TEA1721FT demo board schematic

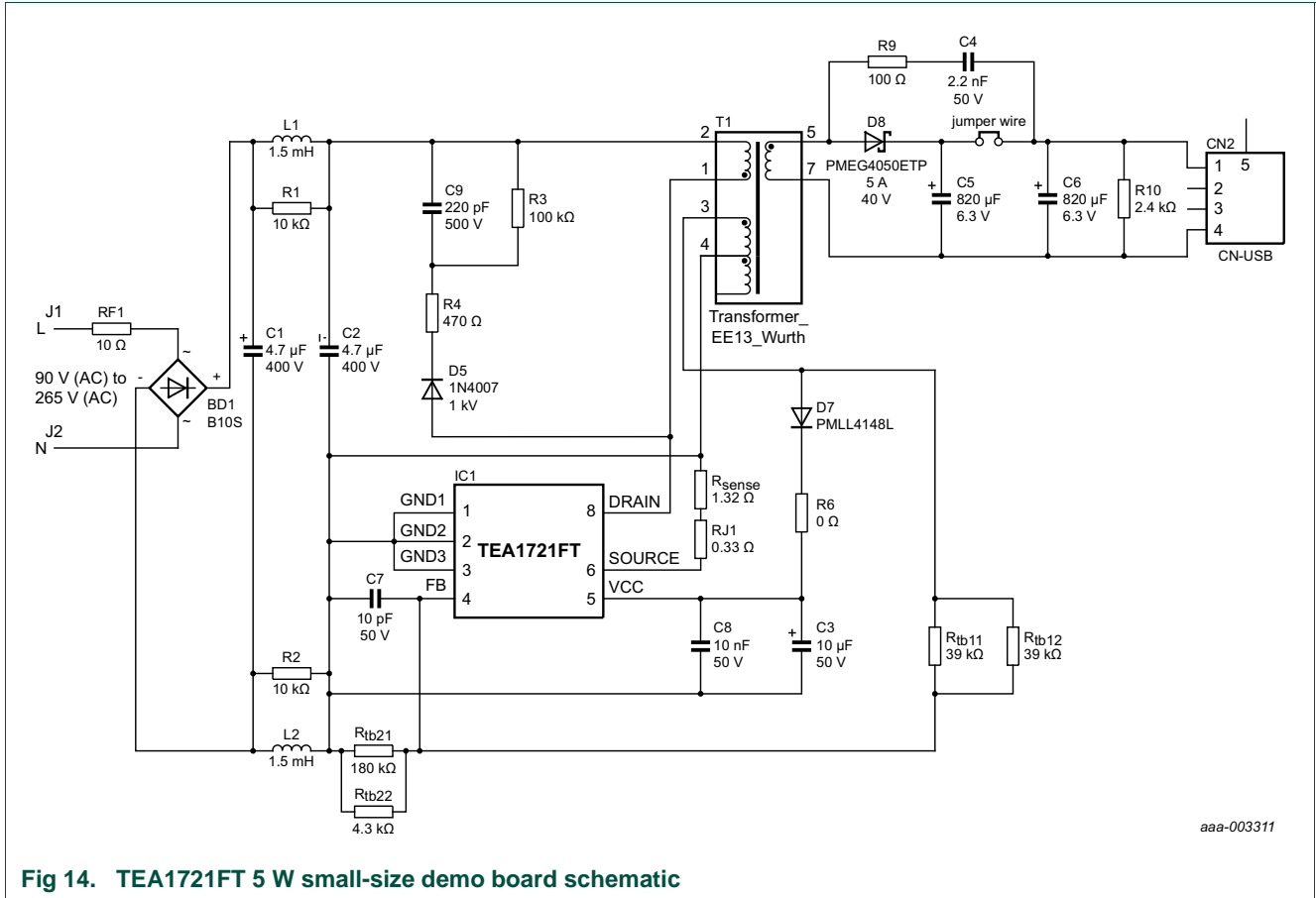

Fig 14. TEA1721FT 5 W small-size demo board schematic

6.2 Bill of materials

Table 4. Bill of materials

Part	Description	Part number	Manufacturer
BD1	B10S; 1 kV; Mini SMD; 0.8 A	B10S-G	Comchip Tech.
C1	4.7 μ F; 400 V; 8 \times 9 mm	AX-series	Rubycon
C2	4.7 μ F; 400 V; 8 \times 9 mm	AX-series	Rubycon
C3	10 μ F; 50 V; 5 \times 11 mm	EKY500ELL100ME11D	United Chemi-Con
C4	2.2 nF; 50 V; 0805	-	-
C5	820 μ F; 6.3 V;	RL80J821MDN1KX	Nichicon
C6	820 μ F; 6.3 V;	RL80J821MDN1KX	Nichicon
C7	10 pF; 0603	-	-
C8	10 nF; 0603	-	-
C9	220 pF; 500 V; film-ceramic	-	-
CN2	USB-port; USB A type flat 4-pin DIP	KS-001PDH-ANB1-L	Kuon Yi
D5	1N4007; 1 kV; DO-41; 1 A	1N4007	Vishay
D7	1N4148; SOD80C glass	PMLL4148L	NXP Semiconductors
D8	PMEG4050ETP; 40 V; DO-214AA(SMB); 5 A	-	NXP Semiconductors
IC1	TEA1721FT; S07	TEA1721FT	NXP Semiconductors
J1	L (line)	pin	-
J2	N (neutral)	pin	-
L1	1.5 mH; DIP	-	-
L2	1.5 mH; DIP	-	-
R1	10 k Ω ; 0805	-	-
R2	10 k Ω ; 0805	-	-
R3	100 k Ω ; 0805	-	-
R4	470 Ω ; 0805	-	-
R _{sense}	1.32 Ω ; DIP; 1 W	-	-
R6	0 Ω ; 0805	-	-
R9	100 Ω ; 0805	-	-
R10	2.4 k Ω ; 0603	-	-
R _{tb11}	39 k Ω ; 0603	-	-
R _{tb12}	39 k Ω ; 0603	-	-
R _{tb21}	4.3 k Ω ; 0603	-	-
R _{tb22}	180 k Ω ; 0603	-	-
RF1	10 Ω ; 2 W; fusible	-	-
RJ1	0.33 Ω ; 1206, 1 %	-	-
T1	2 mH; 124 : 8 : 20 EE13/12/6 horizontal;	-	Würth Elektronik
W1	jumper wire; DIP	-	-

7. Circuit description

The GreenChip SP TEA1721FT demo board consists of a single-phase full-wave rectifier circuit, a filtering section, a switching section, an output section and a feedback section. The circuit diagram is shown in [Figure 14](#) and the component list is shown [Table 4 on page 16](#).

7.1 Rectification section

The bridge diodes BD1 form the single-phase full-wave rectifier. Capacitors C1 and C2 are reservoir capacitors for the rectified input voltage. Resistor RF1 limits inrush current and acts as a fuse. Terminals 1 and 2 connect the input to the electricity utility network. Swapping these two wires has no effect on the operation of the converter.

7.2 Filtering section

Inductors L1 and L2, with capacitors C1 and C2, form 2 filters to attenuate conducted differential mode EMI noise.

7.3 GreenChip SP section

The TEA1721FT device (IC1) contains the power MOS switch, oscillator, CV/CC, start-up control and protection functions all in one IC. Its integrated 700 V MOSFET allows sufficient voltage margins in universal input AC applications, including line surges.

The auxiliary winding on transformer T1 generates the supply voltage and primary sensing information for the TEA1721FT. Diode D7 and capacitor C3 half-wave rectify the voltage. C3 charged via the current limiter resistor R6. The voltage on C3 is the supply voltage for the VCC pin.

The RCD-R clamp consisting of R4, C9, D5 and R3 limits drain voltage spikes caused by leakage inductance of the transformer.

7.4 Output section

Diode D7 is a Schottky barrier type diode and capacitors C5/C6 rectify the voltage from secondary winding of transformer T1. Using a Schottky barrier type diode results in a higher efficiency of the demo board. C5 and C6 must have sufficient low ESR characteristics to meet the output voltage ripple requirement without adding an LC post filter. Resistor R9 and capacitor C4 dampen high frequency ringing and reduce the voltage stress on diode D8. Resistor R10 provides a minimum load to maintain output control in no-load condition.

7.5 Feedback section

The TEA1721FT controls the output by current and frequency control for CV and CC regulation. The auxiliary winding on Transformer T1 senses the output voltage. The FB pin senses the reflected output voltage using feedback resistors R_{tb1} and R_{tb2} .

8. PCB layout

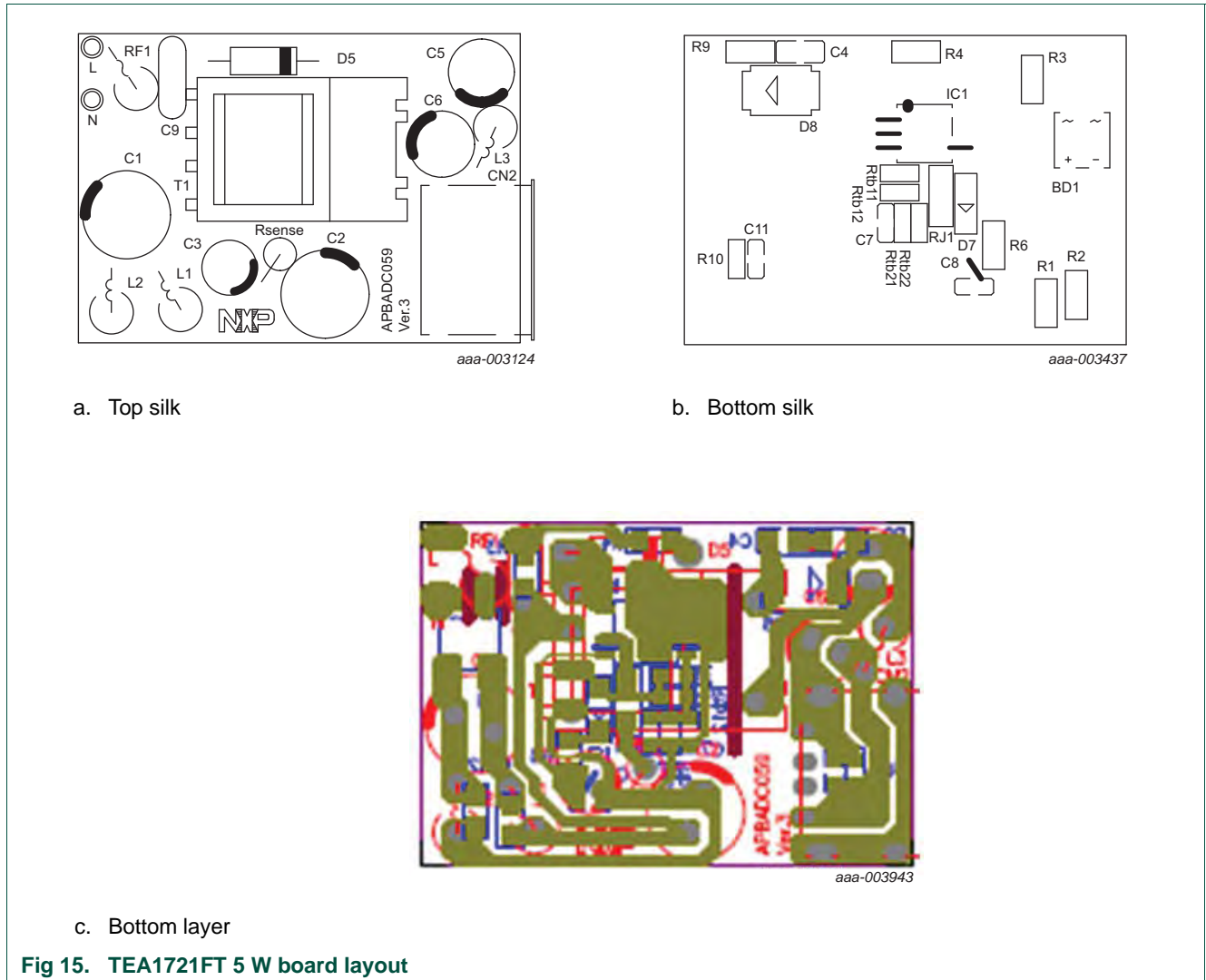

9. Transformer specifications

9.1 Transformer schematic design and winding construction

The transformer used in the small-size demo board has size EE13 with bobbin EE13/12/6 horizontal 7 pins. A few measures have been taken for a low EMI emission. Copper foil shields are used between core and primary windings and between primary windings and secondary windings. The winding start point of the primary winding is connected to the third layer (N3) after second layer N2 is connected to pin 1. The primary windings are using a barrier tape of 1 mm on both sides. The secondary winding is wound with 2 wires in parallel to improve efficiency.

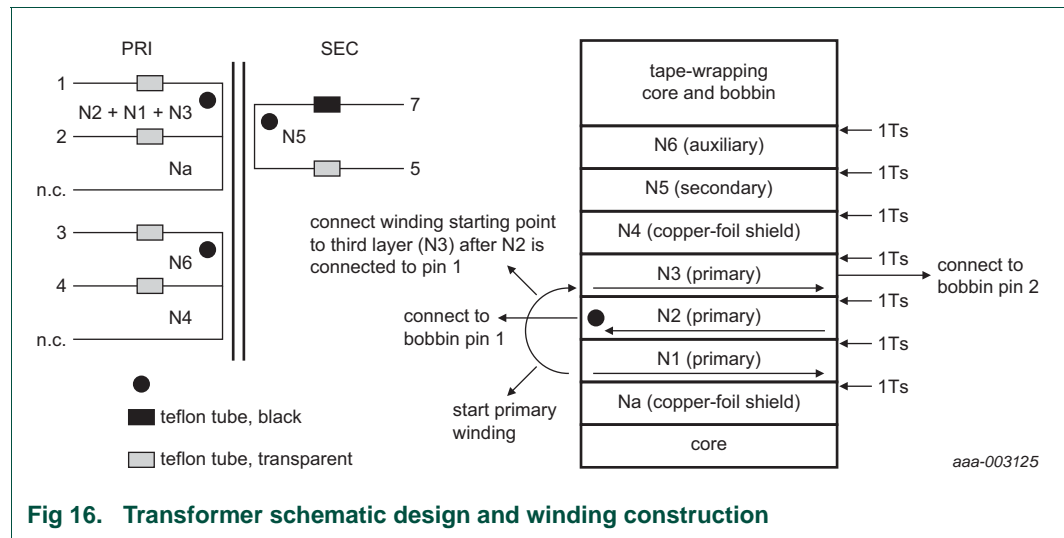

9.2 Winding specification

Table 5. Electrical specification

Winding layer	Wire diameter (φ)	Turns (T)	Winding method	Number of winding layers	Remark	
Na	2	copper foil 0.05 mm × 7.5 mm	1	1	solder to pin 2	
N2 + N1 + N3	1 to 2	2UEW-B 0.12 mm × 1P	143	tight	3	solder to pins 1 and 2
N4	4	copper foil 0.05 mm × 7.5 mm	1	1	1	solder to pin 4
N5	7 to 5	triple wire 0.5 mm × 2P	9	tight	2	solder to pins 7 and 5
N6	3 to 4	2UEW-B 0.2 mm × 1P	23	loose	1	solder to pins 3 and 4

9.3 Electrical characteristics

Table 6. Electrical specification

Parameter	Pin	Value	Remark
primary inductance	1 to 2	2 mH, ±7 %	
Leakage inductance	1 to 2	100 μH	secondary side shorted

9.4 Core, air gap and bobbin

Core: EE13/12 (3C90)

Size of the air gap depends on the A_L value of the ungapped core. After gapping, the A_L of the core will be $98 \text{ nH/T}^2 \pm 10 \%$.

Bobbin: EE13/12/6 horizontal, 7 pins

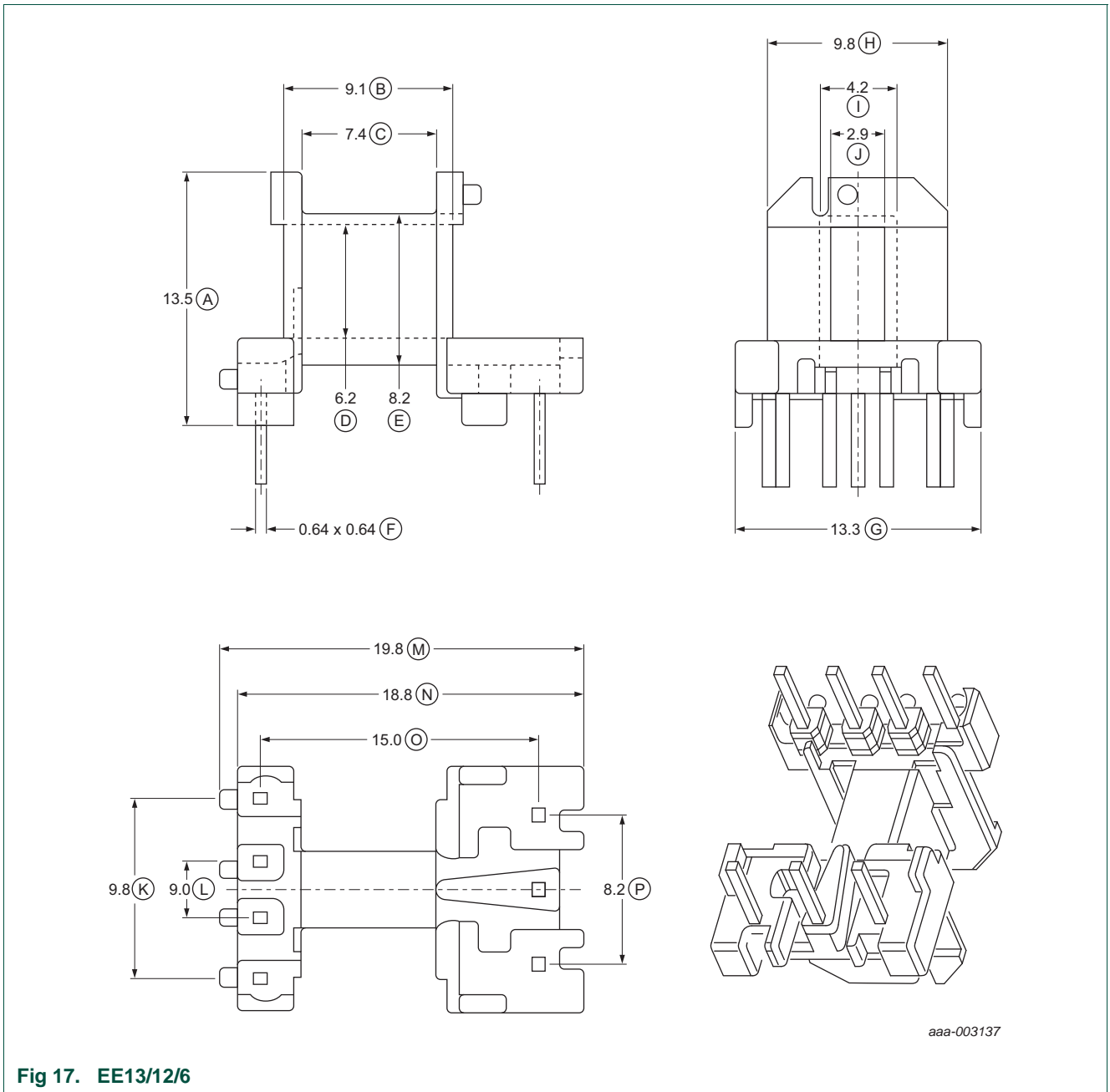

Fig 17. EE13/12/6

9.5 Marking

Würth/Midcom 750341253

10. Attention points

When testing the CC mode of the TEA1721FT, use an electronic DC-load in resistive mode, not in current mode.

The current in CC mode has a small fold back characteristic (see [Figure 5](#)). When the current mode of an electronic DC-load is used, the output voltage drops immediate to zero when the maximum current is exceeded. Once the output voltage and the input voltage of the DC-load is zero, many DC-loads cannot adjust the current. Using the resistive mode of the electronic DC-load avoids this problem.

Remark: This TEA1721FT controller behavior is not incorrect. Only test it in the correct way.

11. References

- [1] **TEA1721AT/BT/DT/FT** — data sheets: ultra-low standby SMPS controller with integrated power switch
- [2] **TEA1723AT/BT/DT/FT** — data sheets: ultra-low standby SMPS controller with integrated power switch data sheet
- [3] **AN11029** — Application note: Using TEA1721/TEA1723 ultra-low standby SMPS controller ICs in white goods applications
- [4] **AN11060** — Application note: TEA172X 5 W to 11 W power supply/usb charger
- [5] **UM10520** — TEA1721 Isolated 3-phase universal mains flyback converter demo board user manual
- [6] **UM10521** — TEA1721 isolated universal mains flyback converter demo board user manual
- [7] **UM10522** — TEA1721 non-isolated universal mains buck and buck/boost converter demo board user manual
- [8] **UM10523** — TEA1721 universal mains white goods flyback SMPS demo board user manual

12. Legal information

12.1 Definitions

Draft — The document is a draft version only. The content is still under internal review and subject to formal approval, which may result in modifications or additions. NXP Semiconductors does not give any representations or warranties as to the accuracy or completeness of information included herein and shall have no liability for the consequences of use of such information.

12.2 Disclaimers

Limited warranty and liability — Information in this document is believed to be accurate and reliable. However, NXP Semiconductors does not give any representations or warranties, expressed or implied, as to the accuracy or completeness of such information and shall have no liability for the consequences of use of such information. NXP Semiconductors takes no responsibility for the content in this document if provided by an information source outside of NXP Semiconductors.

In no event shall NXP Semiconductors be liable for any indirect, incidental, punitive, special or consequential damages (including - without limitation - lost profits, lost savings, business interruption, costs related to the removal or replacement of any products or rework charges) whether or not such damages are based on tort (including negligence), warranty, breach of contract or any other legal theory.

Notwithstanding any damages that customer might incur for any reason whatsoever, NXP Semiconductors' aggregate and cumulative liability towards customer for the products described herein shall be limited in accordance with the *Terms and conditions of commercial sale* of NXP Semiconductors.

Right to make changes — NXP Semiconductors reserves the right to make changes to information published in this document, including without limitation specifications and product descriptions, at any time and without notice. This document supersedes and replaces all information supplied prior to the publication hereof.

Suitability for use — NXP Semiconductors products are not designed, authorized or warranted to be suitable for use in life support, life-critical or safety-critical systems or equipment, nor in applications where failure or malfunction of an NXP Semiconductors product can reasonably be expected to result in personal injury, death or severe property or environmental damage. NXP Semiconductors and its suppliers accept no liability for inclusion and/or use of NXP Semiconductors products in such equipment or applications and therefore such inclusion and/or use is at the customer's own risk.

Applications — Applications that are described herein for any of these products are for illustrative purposes only. NXP Semiconductors makes no representation or warranty that such applications will be suitable for the specified use without further testing or modification.

Customers are responsible for the design and operation of their applications and products using NXP Semiconductors products, and NXP Semiconductors accepts no liability for any assistance with applications or customer product design. It is customer's sole responsibility to determine whether the NXP Semiconductors product is suitable and fit for the customer's applications and products planned, as well as for the planned application and use of customer's third party customer(s). Customers should provide appropriate design and operating safeguards to minimize the risks associated with their applications and products.

NXP Semiconductors does not accept any liability related to any default, damage, costs or problem which is based on any weakness or default in the customer's applications or products, or the application or use by customer's third party customer(s). Customer is responsible for doing all necessary testing for the customer's applications and products using NXP Semiconductors products in order to avoid a default of the applications and the products or of the application or use by customer's third party customer(s). NXP does not accept any liability in this respect.

Export control — This document as well as the item(s) described herein may be subject to export control regulations. Export might require a prior authorization from competent authorities.

Evaluation products — This product is provided on an "as is" and "with all faults" basis for evaluation purposes only. NXP Semiconductors, its affiliates and their suppliers expressly disclaim all warranties, whether express, implied or statutory, including but not limited to the implied warranties of non-infringement, merchantability and fitness for a particular purpose. The entire risk as to the quality, or arising out of the use or performance, of this product remains with customer.

In no event shall NXP Semiconductors, its affiliates or their suppliers be liable to customer for any special, indirect, consequential, punitive or incidental damages (including without limitation damages for loss of business, business interruption, loss of use, loss of data or information, and the like) arising out of the use of or inability to use the product, whether or not based on tort (including negligence), strict liability, breach of contract, breach of warranty or any other theory, even if advised of the possibility of such damages.

Notwithstanding any damages that customer might incur for any reason whatsoever (including without limitation, all damages referenced above and all direct or general damages), the entire liability of NXP Semiconductors, its affiliates and their suppliers and customer's exclusive remedy for all of the foregoing shall be limited to actual damages incurred by customer based on reasonable reliance up to the greater of the amount actually paid by customer for the product or five dollars (US\$5.00). The foregoing limitations, exclusions and disclaimers shall apply to the maximum extent permitted by applicable law, even if any remedy fails of its essential purpose.

12.3 Trademarks

Notice: All referenced brands, product names, service names and trademarks are the property of their respective owners.

GreenChip — is a trademark of NXP B.V.

13. Contents

1	Introduction	3
2	Safety Warning	3
3	Features	4
4	Technical specification	4
5	performance data	6
5.1	No-load Input power dissipation	6
5.2	Output voltage and efficiency performance data	7
5.3	Dynamic loading from 0 A to 0.5 A	9
5.4	Dynamic loading from 0.5 A to 0 A	10
5.5	Short-circuit of the output	11
5.6	Output voltage ripple performance	12
5.7	Conducted EMI measurements results.....	13
6	Schematic and Bill Of Material (BOM)	15
6.1	Small-size 5 W TEA1721FT demo board schematic	15
6.2	Bill of materials	16
7	Circuit description	17
7.1	Rectification section	17
7.2	Filtering section	17
7.3	GreenChip SP section	17
7.4	Output section	17
7.5	Feedback section	17
8	PCB layout	18
9	Transformer specifications	19
9.1	Transformer schematic design and winding construction	19
9.2	Winding specification	19
9.3	Electrical characteristics	19
9.4	Core, air gap and bobbin	20
9.5	Marking.....	20
10	Attention points	21
11	References	22
12	Legal information	23
12.1	Definitions	23
12.2	Disclaimers	23
12.3	Trademarks	23
13	Contents	24

Please be aware that important notices concerning this document and the product(s) described herein, have been included in section 'Legal information'.

© NXP B.V. 2012.

All rights reserved.

For more information, please visit: <http://www.nxp.com>

For sales office addresses, please send an email to: salesaddresses@nxp.com

Date of release: 21 June 2012

Document identifier: UM10548