



UM10886

TEA1720ADB1180 10 W EPC17 demo board

Rev. 1 — 2 March 2015

User manual

Document information

Info	Content
Keywords	TEA1720ADB1180, TEA1720B3T, TEA1705, ultra-low standby power, constant output voltage, constant output current, primary sensing, integrated high-voltage start-up, smartphone and tablet charger, 5 V/2.0 A supply, SMPS transient controller
Abstract	This user manual describes the TEA1720ADB1180 10 W Constant Voltage/Constant Current (CV/CC) universal input power supply for tablet adapters/chargers. This demo board is based on the GreenChip Smart Power TEA1720B3T and the TEA1705 transient controller. The TEA1720B3T and TEA1705 application enables a no-load power consumption of less than 20 mW and a low external component count for cost-effective applications. In addition, the TEA1720B3T provides advanced control modes for optimal performance. The TEA1705 transient controller continuously monitors the output voltage. When the output voltage drops below the detection level V_{det} (V_{CC}), a transient interrupt signal is generated to wake up the TEA1720B3T.



Revision history

Rev	Date	Description
v.1	20150302	first issue

Contact information

For more information, please visit: <http://www.nxp.com>

For sales office addresses, please send an email to: salesaddresses@nxp.com

1. Introduction

WARNING

Lethal voltage and fire ignition hazard



The non-insulated high voltages that are present when operating this product, constitute a risk of electric shock, personal injury, death and/or ignition of fire.

This product is intended for evaluation purposes only. It shall be operated in a designated test area by personnel qualified according to local requirements and labor laws to work with non-insulated mains voltages and high-voltage circuits. This product shall never be operated unattended.

This user manual describes the TEA1720ADB1180 10 W Constant Voltage or Constant Current (CV/CC) universal input power supply for tablet adapters and chargers. This demo board is based on the TEA1720B3T GreenChip SP-integrated circuit.

The TEA1720B3T GreenChip SP provides ultra-low no-load power consumption without using additional external components. Designs are cost-effective using the TEA1720B3T GreenChip SP because only a few external components are needed in a typical application.

The additional TEA1705 transient controller ensures excellent transient response in no-load mode.

Remark: All voltages are in V (AC) unless otherwise stated

2. Safety warning

The complete demo board application is AC mains voltage powered. Avoid touching the board when power is applied. An isolated housing is obligatory when used in uncontrolled, non-laboratory environments. Always provide galvanic isolation of the mains phase using a variable transformer. The following symbols identify isolated and non-isolated devices.

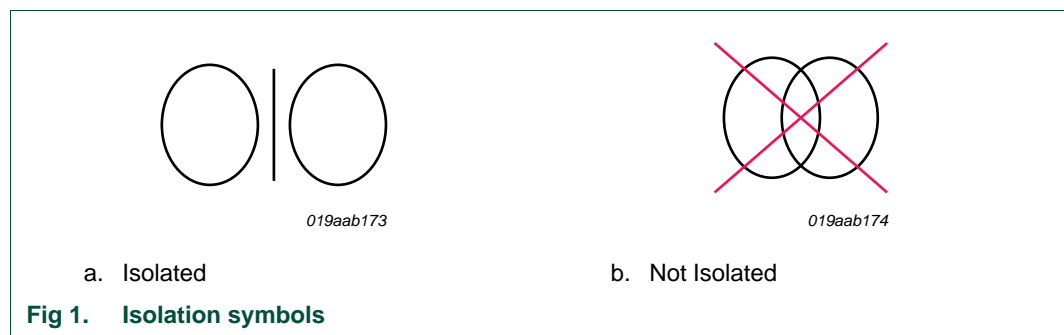

3. Features

3.1 Power features

- Low component count for cost-effective design
- Universal mains input
- Isolated output
- Highly efficient > 80 %
- Primary sensing for control of the output voltage without optocoupler and secondary feedback circuitry
- Built-in emitter switch for driving low-cost NPN high-voltage transistor
- Minimizes audible noise in all operation modes
- Energy Star 2.0 compliant
- Jitter function for reduced EMI
- Excellent transient performance with ultra low no-load power and small output capacitors
- Cable compensation 0.3 V at maximum power

3.2 Green features

- No-load power consumption < 20 mW
- Very low supply current in no-load condition with energy save mode
- Incorporates a high-voltage start-up circuit with zero current consumption under normal switching operation

3.3 Protection features

- OverVoltage Protection (OVP) with auto-restart
- UnderVoltage LockOut (UVLO) and OverVoltage Protection (OVP) on IC supply pin
- OverTemperature Protection (OTP)
- Sense pin short protection
- Hiccup function for automatic switch-off at continuous too low output voltage
- Demagnetization protection for guaranteed discontinuous conduction mode operation
- Open and short-circuit protection of the Feedback control (FB) pin
- Short-circuit protection of the charger output

4. Technical specifications

Table 1. Input specifications

Parameter	Conditions	Value	Remark
input voltage	-	90 V to 265 V	universal AC mains
input frequency	-	47 Hz to 63 Hz	-
average no-load input power consumption	no-load	17.5 mW	average of 115 V and 230 V

Table 2. Output specifications

Parameter	Conditions	Value	Remark
output voltage	-	5.0 V	-
nominal output current	-	2.0 A	-
nominal output power	-	10.0 W	-

5. Board photographs

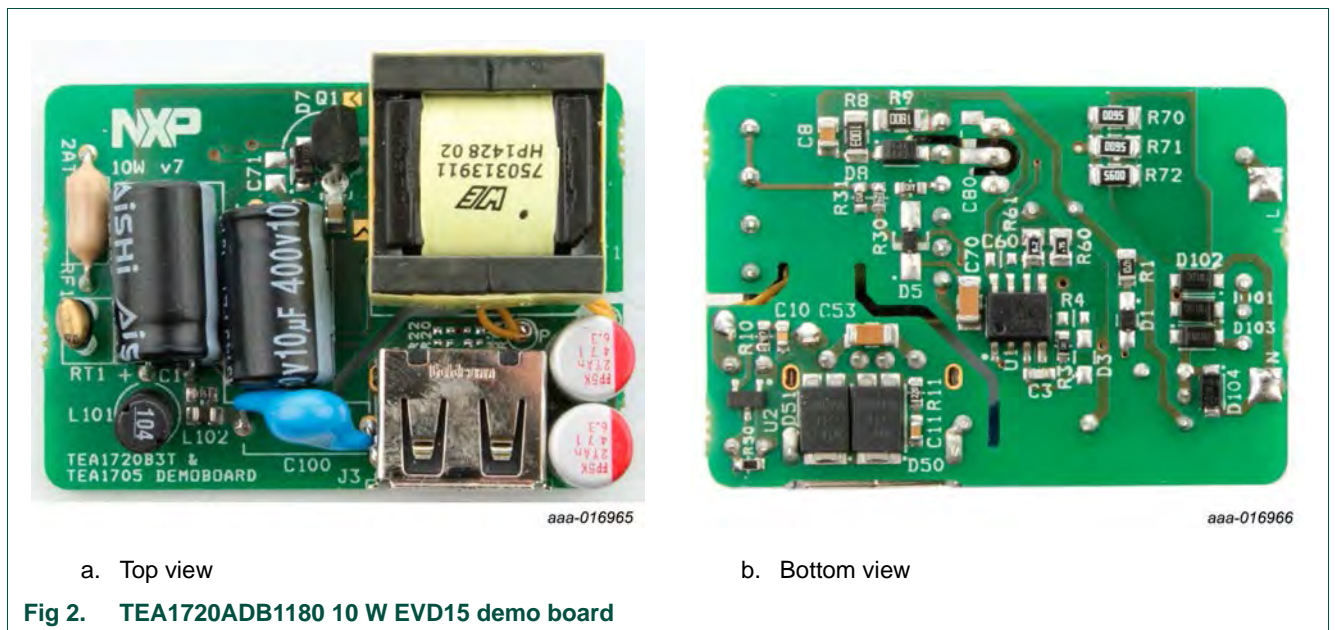

6. Performance data

6.1 No-load input power consumption

The no-load input power has been measured 20 minutes after switch-on. [Table 3](#) and [Figure 3](#) show the results.

Table 3. No-load input power consumption

V _{mains} (V)	Output voltage (V)	Power consumption (mW)
90	5.183	18.1
115	5.18	17.5
230	5.164	17.4
265	5.158	18.2

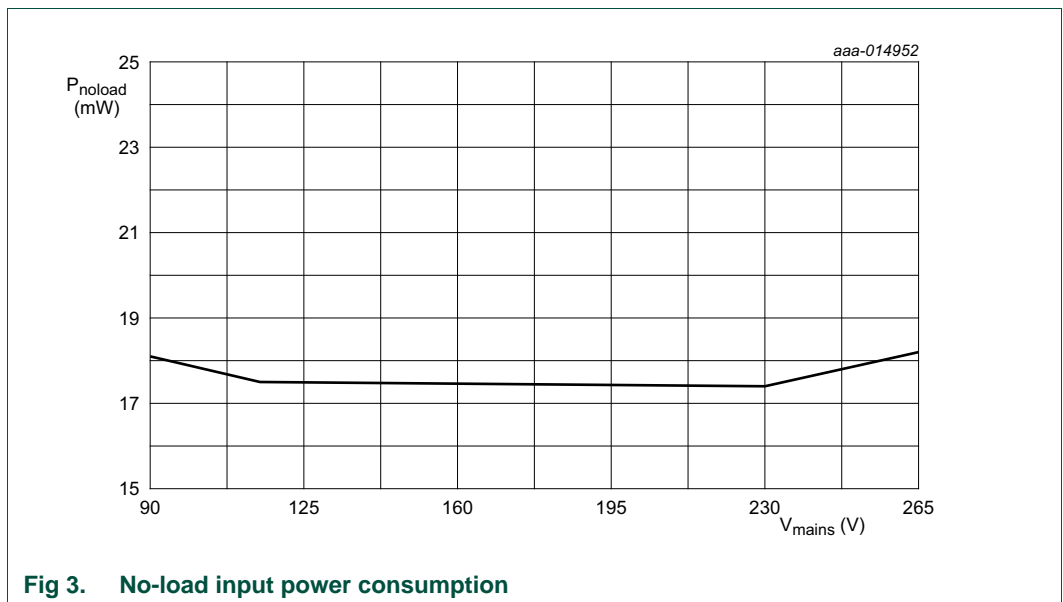
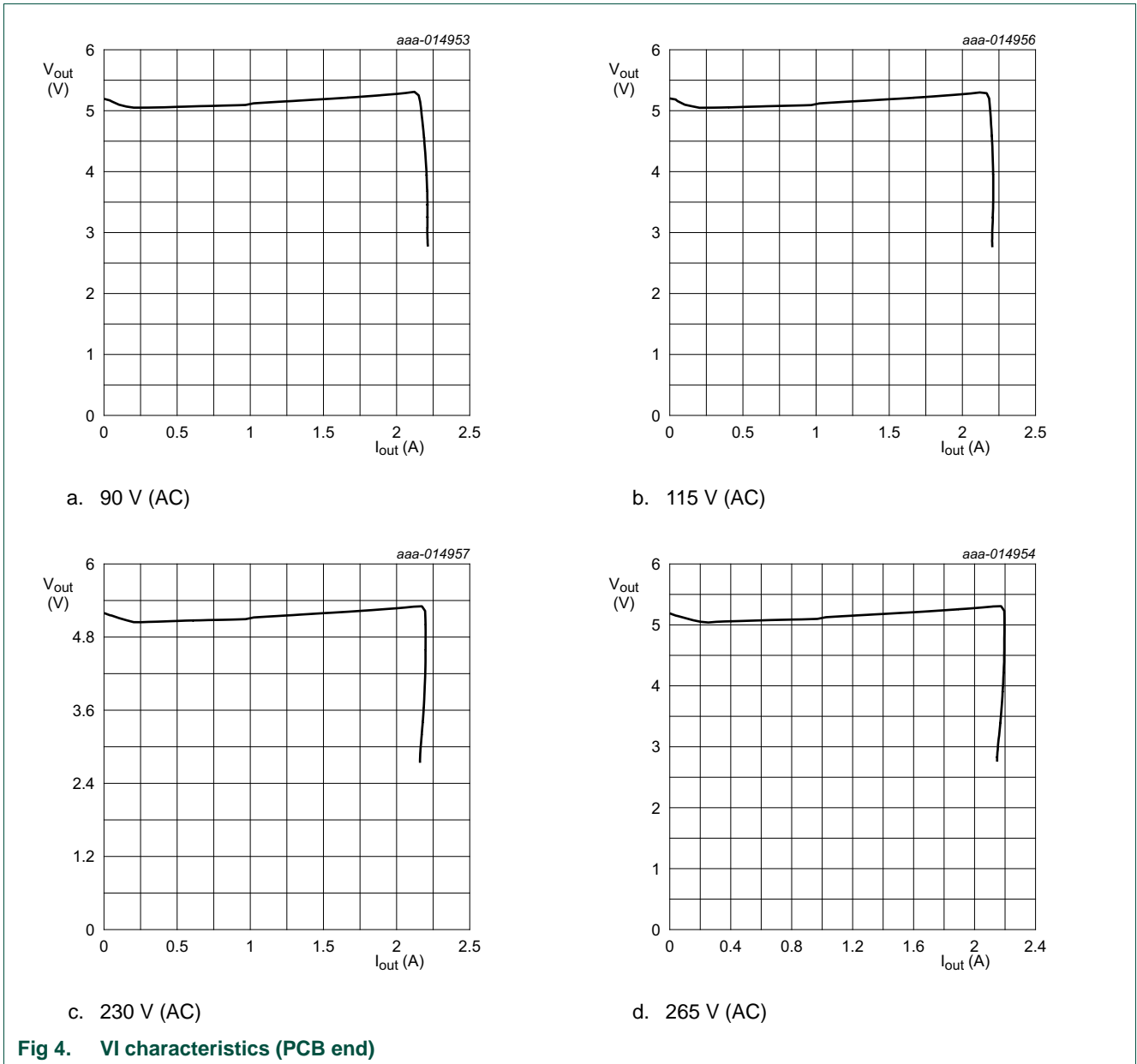

Fig 3. No-load input power consumption

6.2 VI curves

Figure 4 shows the VI characteristics measured at the PCB end.



Below $V_{out} = 2.7$ V at the PCB end, the controller enters the hiccup mode.

Figure 5 shows the VI characteristics measured at the cable end.

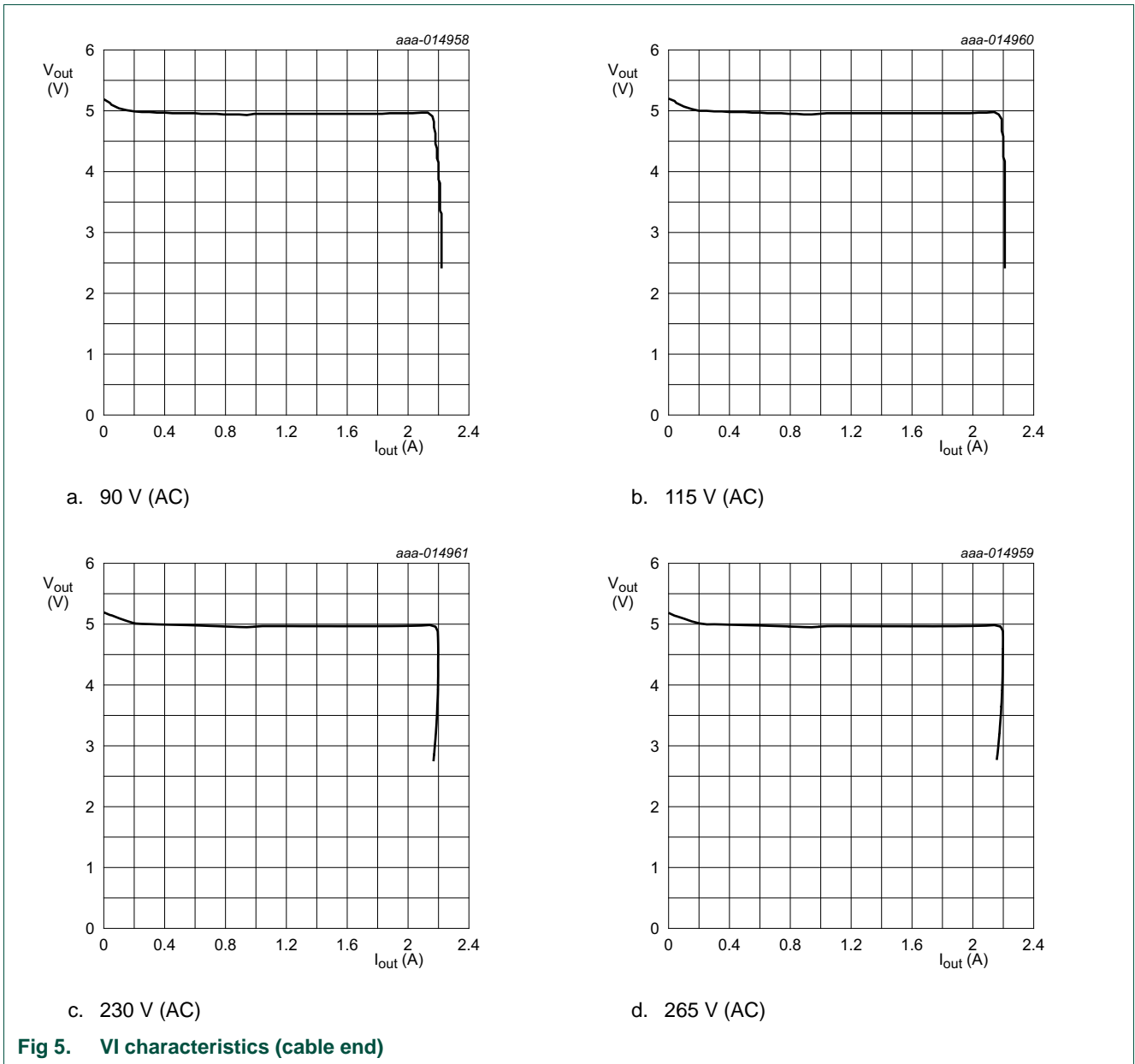

Below $V_{out} = 2.4$ V at the cable end the controller enters the hiccup mode.

6.3 Efficiency

Figure 6 shows the efficiency at 90 V, 115 V, 230 V and 265 V.

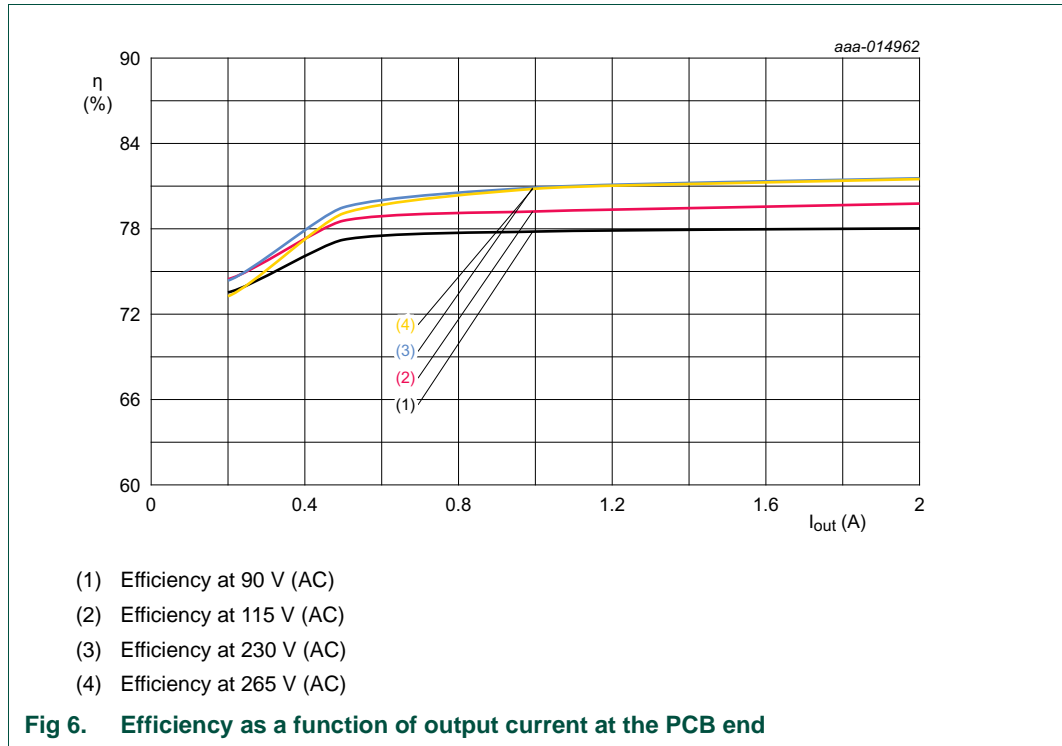

Table 4. Efficiency PCB end

V _{in} (V (AC))	I _{out} (A)	V _{out} (V)	Pin (W)	efficiency (%)	Average 0.5 A to 2.0 A
90	0.200	5.012	1.361	73.534	77.753
	0.499	5.040	3.258	77.224	
	0.999	5.108	6.557	77.806	
	1.500	5.192	9.990	77.951	
	2.000	5.292	13.561	78.029	
115	0.200	5.009	1.342	74.463	79.265
	0.499	5.035	3.199	78.561	
	0.999	5.105	6.435	79.219	
	1.500	5.187	9.783	79.504	
	1.999	5.284	13.242	79.774	
230	0.200	5.014	1.346	74.366	80.807
	0.499	5.043	3.167	79.497	
	0.999	5.109	6.308	80.895	
	1.500	5.193	9.581	81.285	
	2.000	5.283	12.953	81.551	

Table 4. Efficiency PCB end ...continued

V _{in} (V (AC))	I _{out} (A)	V _{out} (V)	Pin (W)	efficiency (%)	Average 0.5 A to 2.0 A
265	0.200	5.020	1.368	73.260	80.646
	0.499	5.044	3.185	79.068	
	0.999	5.111	6.317	80.814	
	1.500	5.195	9.594	81.207	
	2.000	5.286	12.969	81.494	

6.4 Transient response TEA1720B3T

The transient response for the TEA1720B3T (300 mV cable compensation) has been tested with load steps at 90 V and 265 V at the PCB end and at the end of the cable from:

- 0 A → 0.5 A → 0 A
- 0 A → 1.0 A → 0 A
- 0 A → 2.0 A → 0 A

Figure 7 to Figure 9 show the load step response, measured at PCB end.

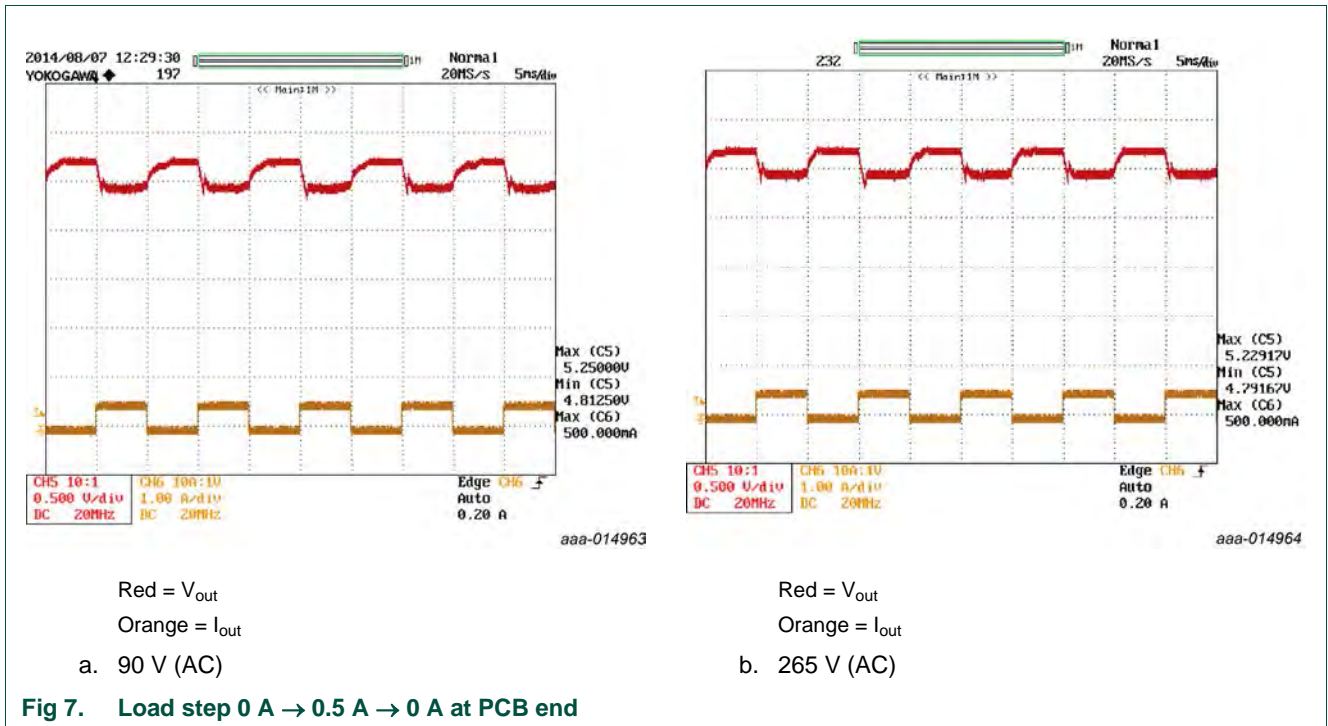

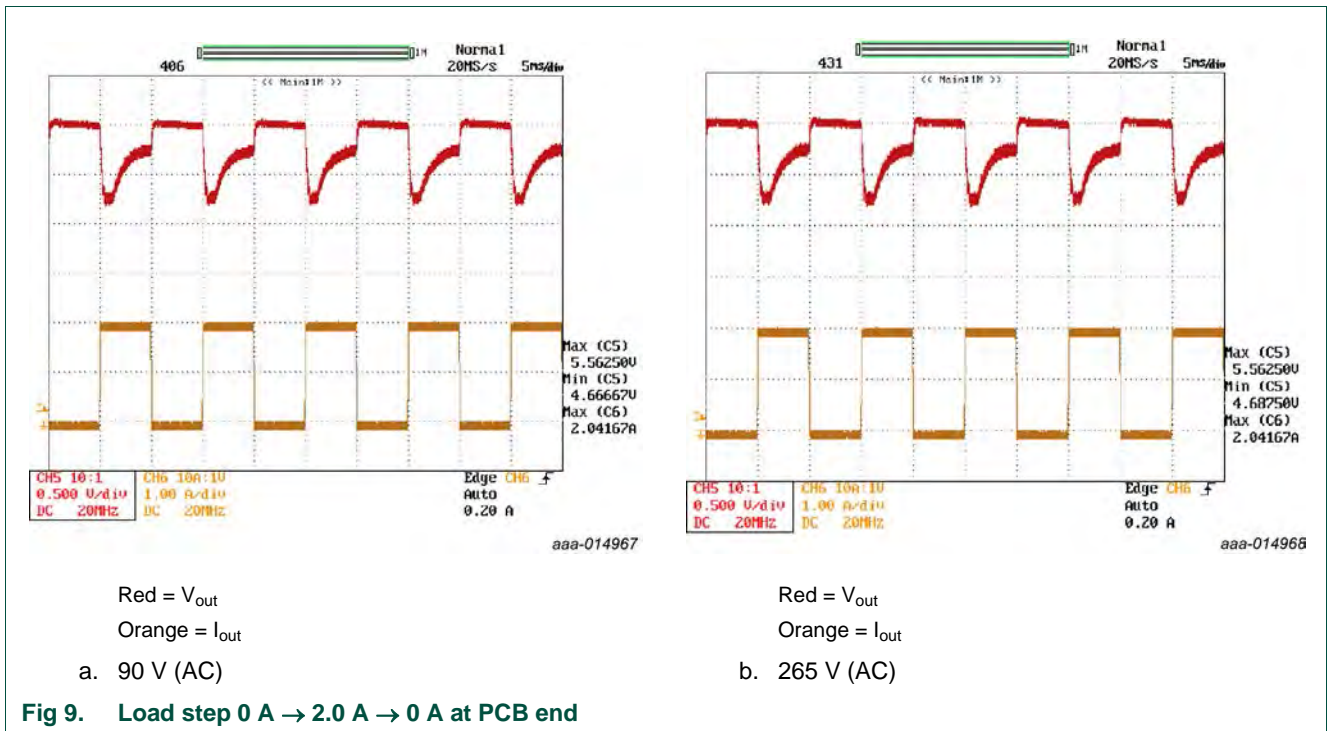
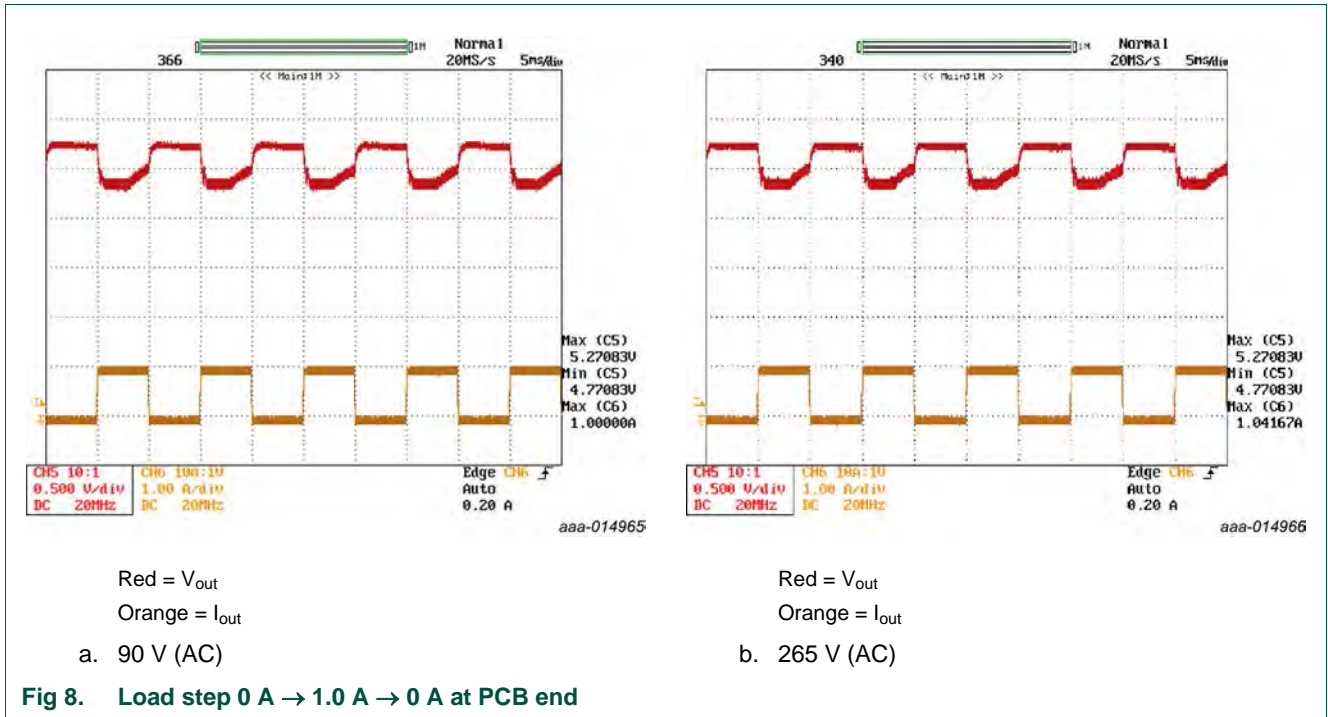
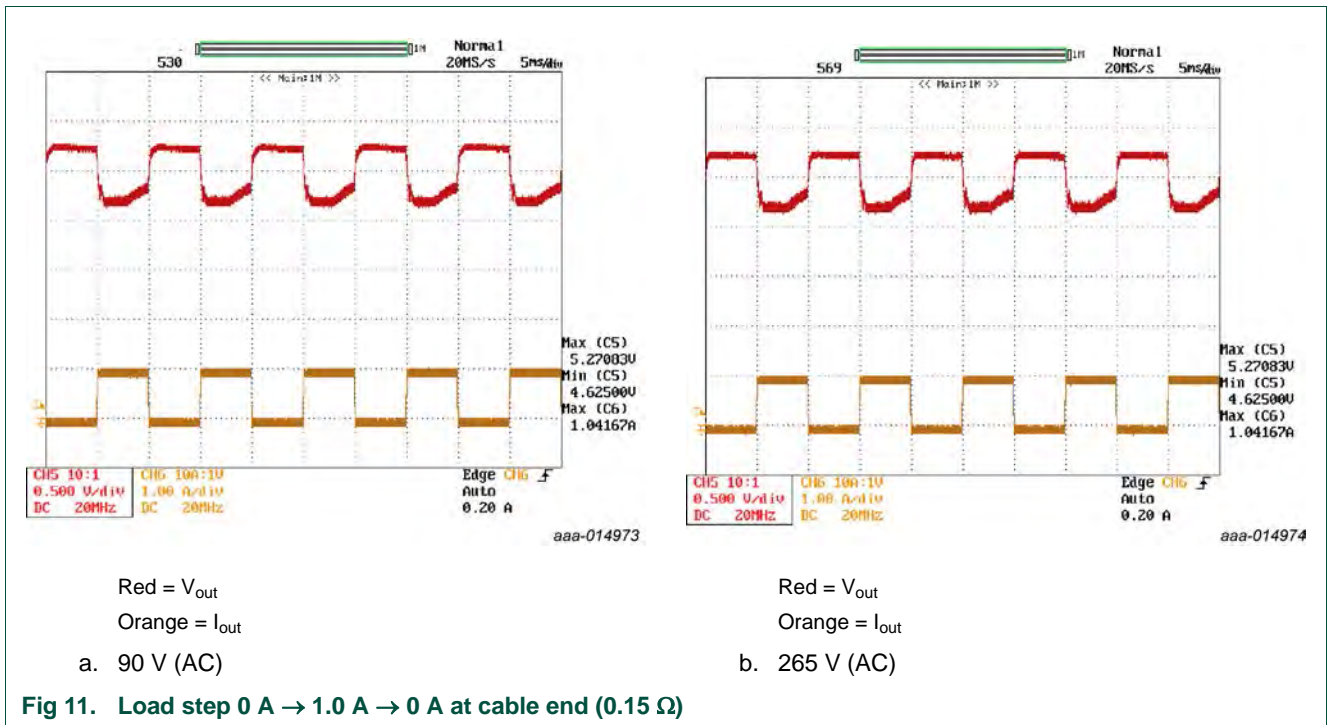
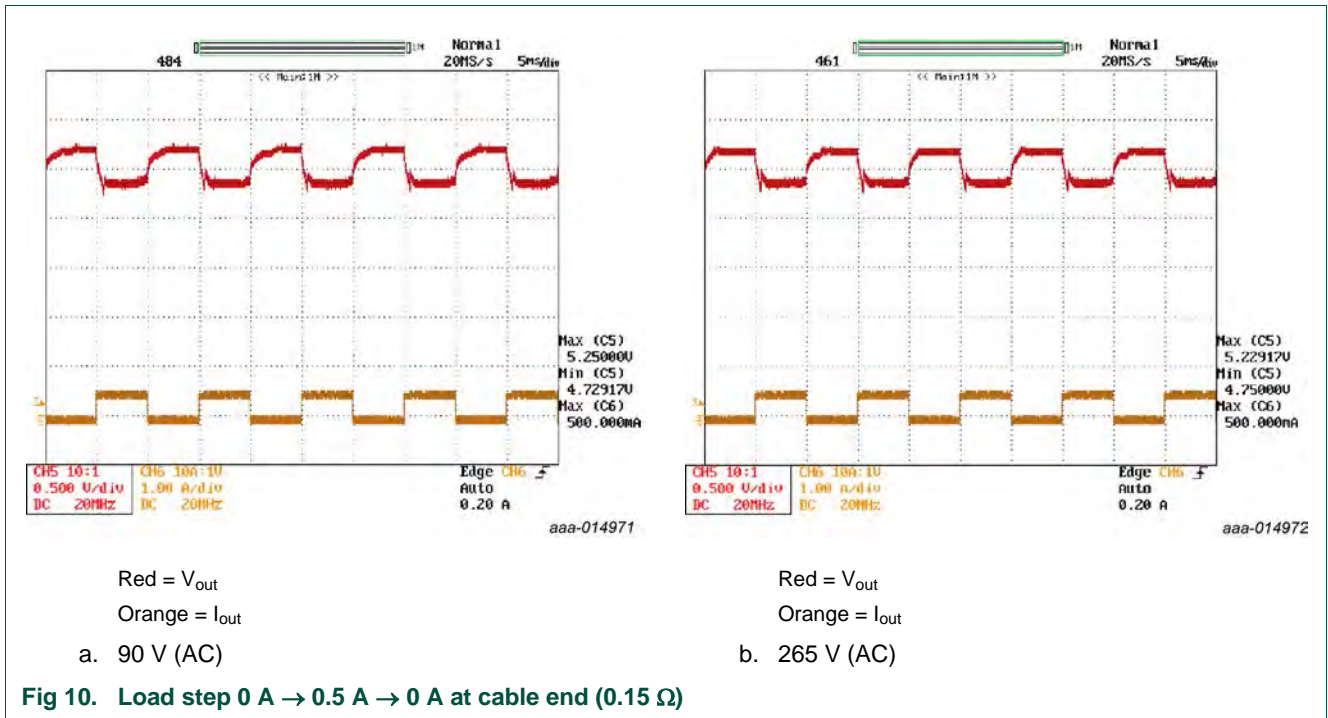
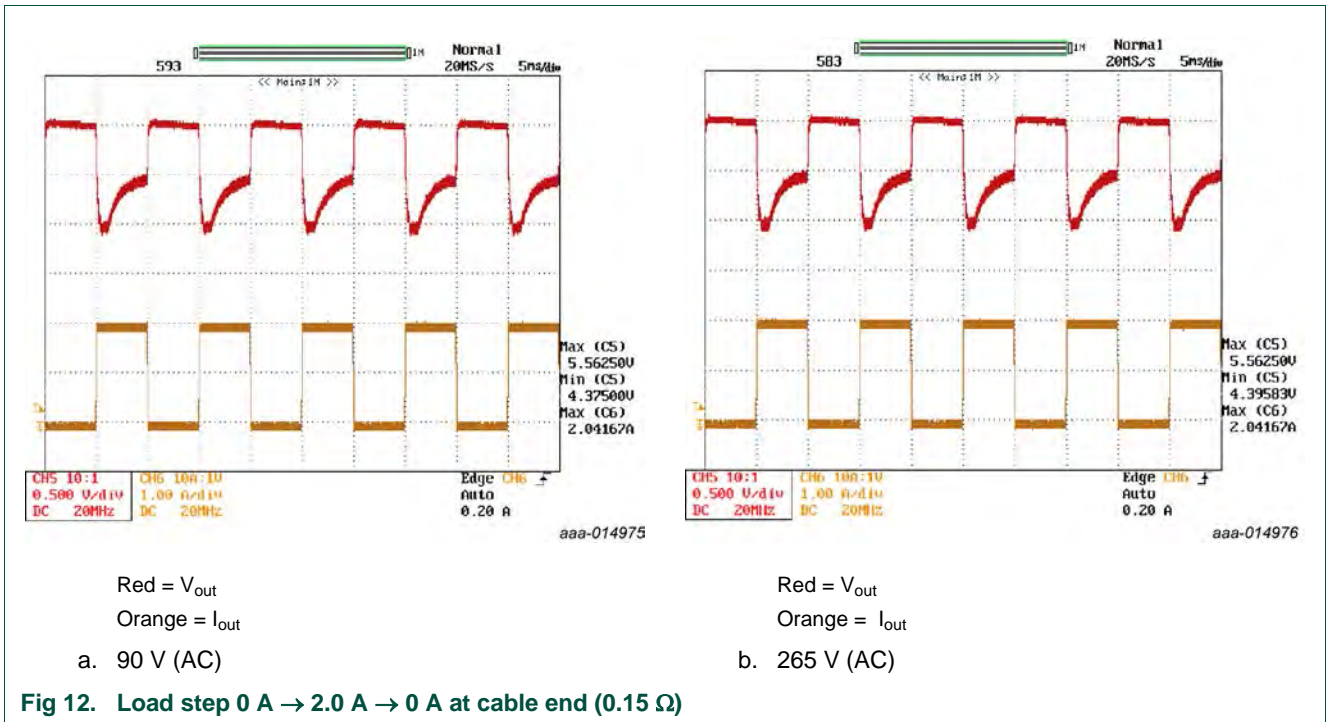

Figure 10 to Figure 12 show the load step response measured at cable end (0.15 Ω).





6.5 Turn-on delay and output rise time

Figure 13 shows the turn-on the delay of the output of the supply at 90 V and 265 V with no-load and 2 A load.

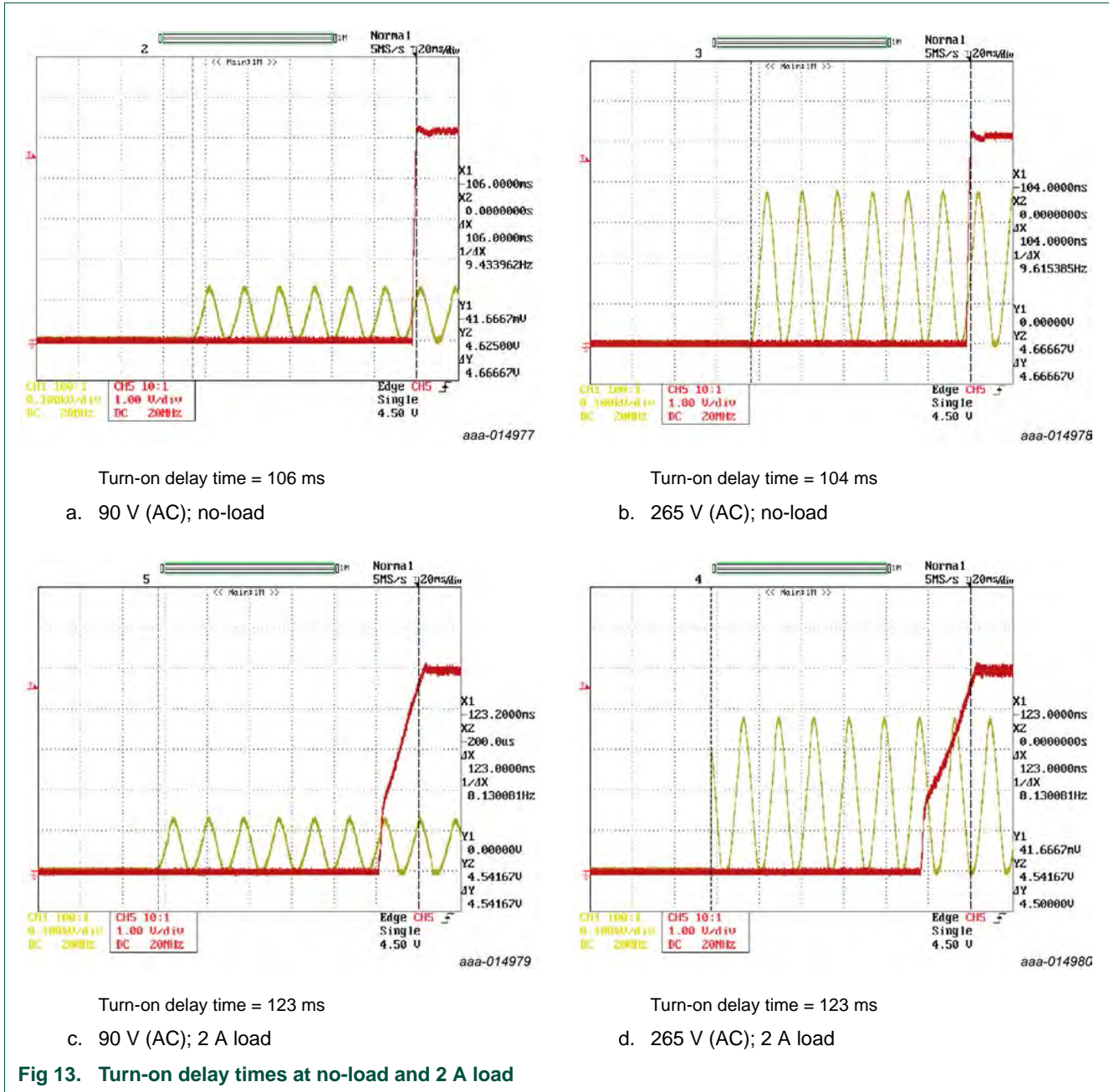
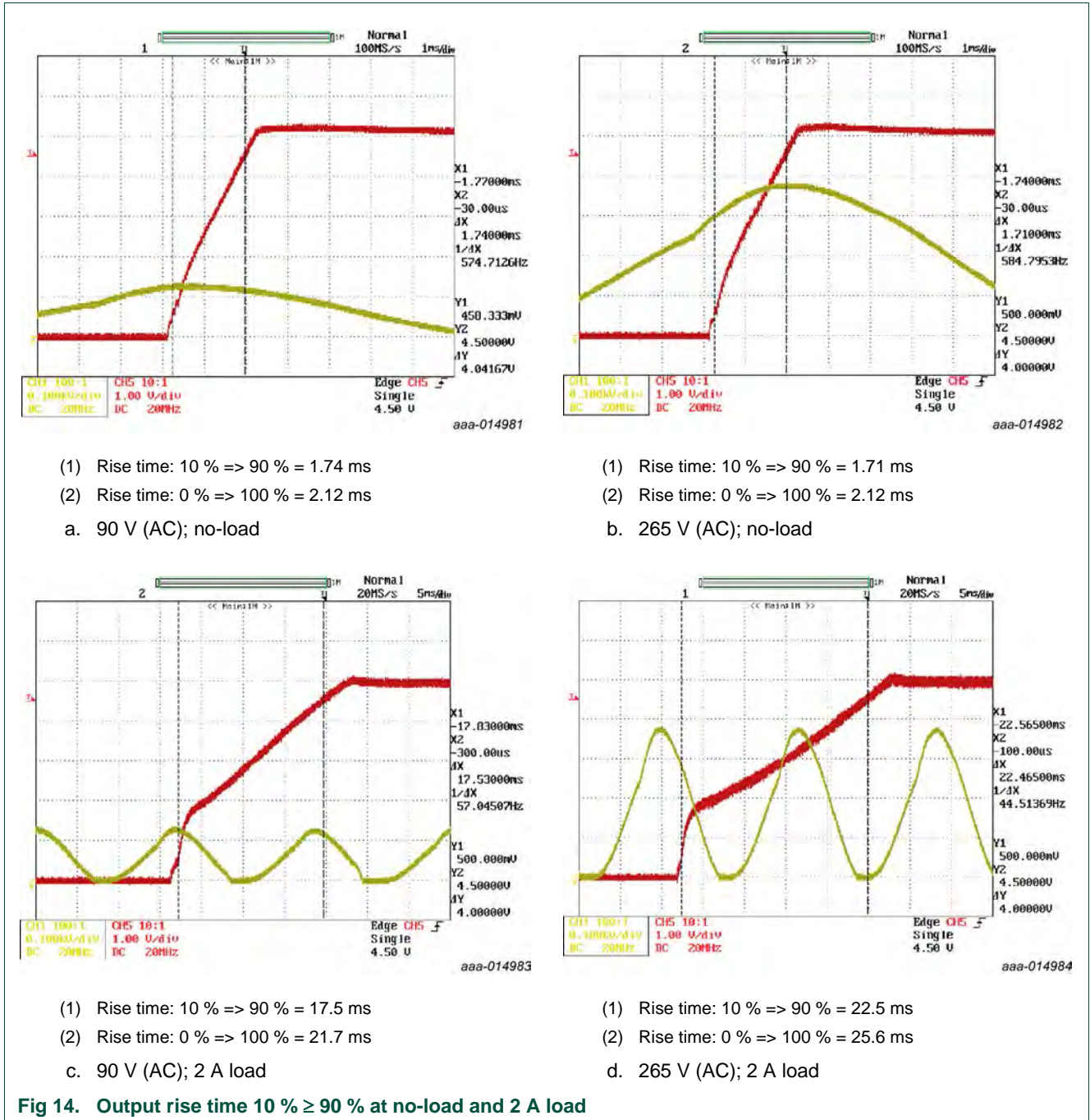
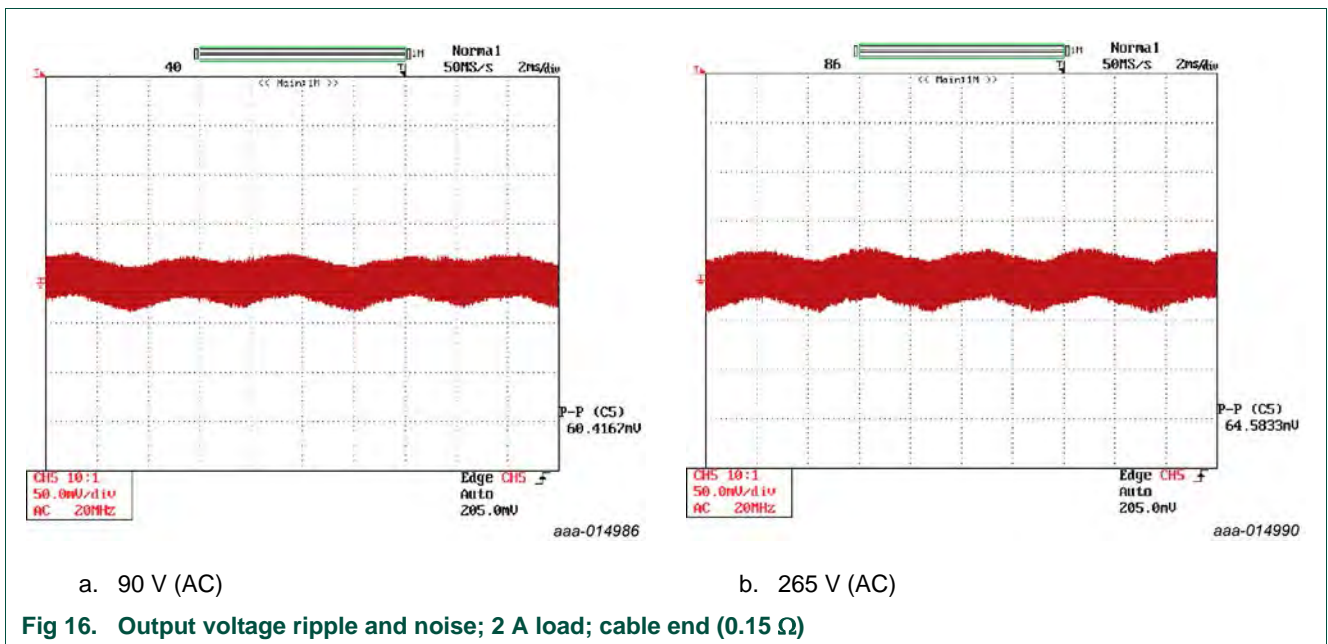
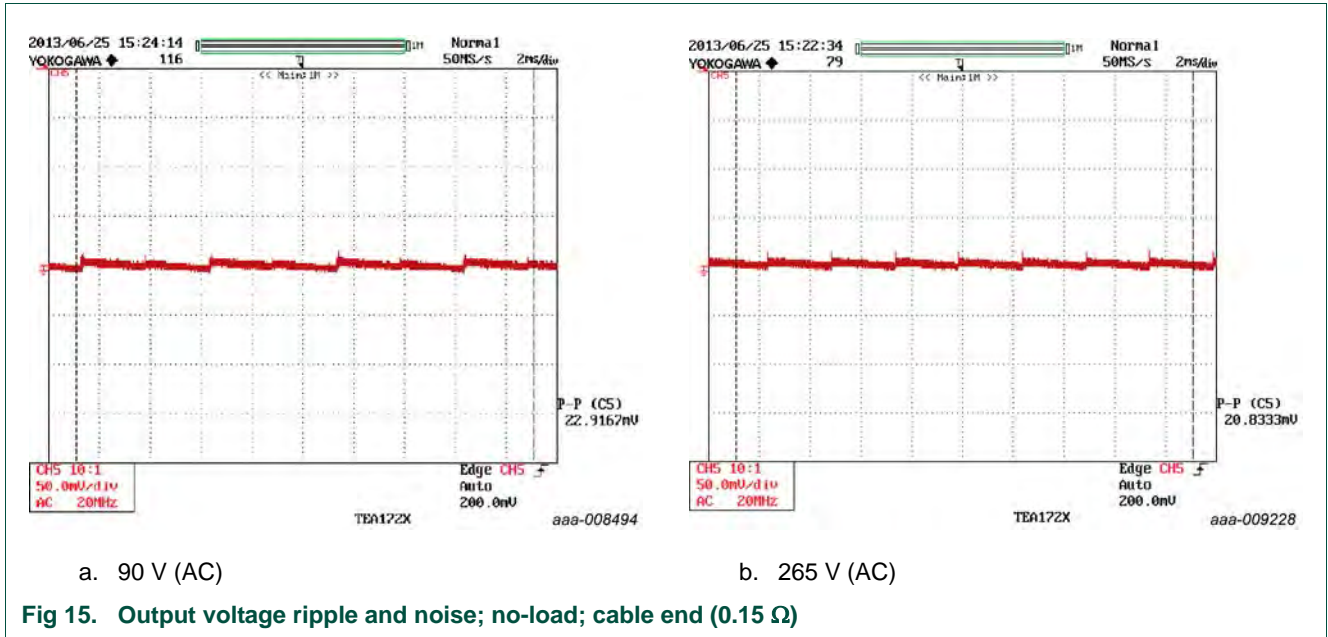

Figure 14 shows the rise time of the output from 10 % to 90 % at 90 V and 265 V with no-load and 2 A load.



6.6 Output voltage ripple and noise performance

The output voltage ripple and noise performance has been measured with an oscilloscope probe connected to the output of the demo board. A probe tip was used with a very short GND connection. A 100 nF ceramic capacitor and a 10 μF electrolytic capacitor are used in parallel with the probe tip to terminate the output. The output voltage ripple and noise has been measured at 90 V and 265 V both at no-load and 2 A load. [Figure 15](#) and [Figure 16](#) show the results.



6.7 Inrush current

The inrush current is limited in the demo board by an NTC in series with the mains.

Table 5 shows the value of the peak inrush current.

Table 5. Inrush current (A peak)

V _{in} (V)	90 V	115 V	230 V	265 V
I _{out} = 0 A	8.3 A peak	11.0 A peak	23.3 A peak	27.3 A peak
I _{out} = 2 A	8.6 A peak	11.1 A peak	24.1 A peak	27.6 A peak

6.8 Short circuit

When the output is shorted, the controller enters hiccup mode. The input power and average output current is given in Table 6.

Table 6. Short circuit input power and average output current

Shorted output	90 V (AC)	265 V (AC)
input power	0.97 W	0.87 W
average output current	0.88 A	0.63 A

6.9 Conducted EMI

The conducted EMI is measured according to EN55022 without the secondary GND connected to the protective mains ground and from 150 kHz to 30 MHz. Figure 17 and Figure 18 show the results. The red crosses show the quasi peak values.

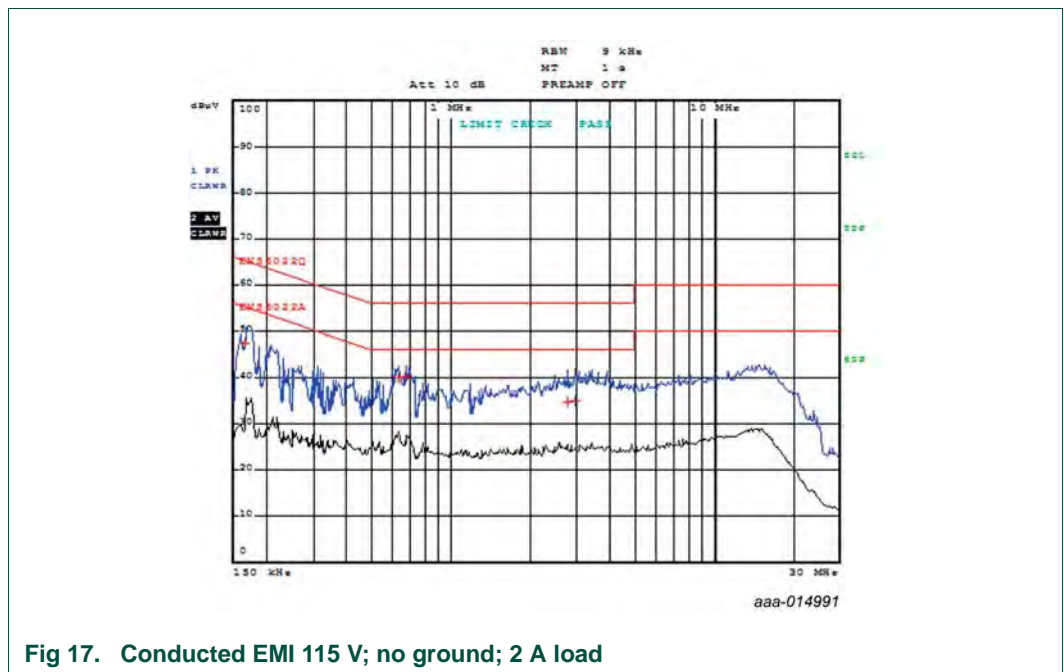

Fig 17. Conducted EMI 115 V; no ground; 2 A load

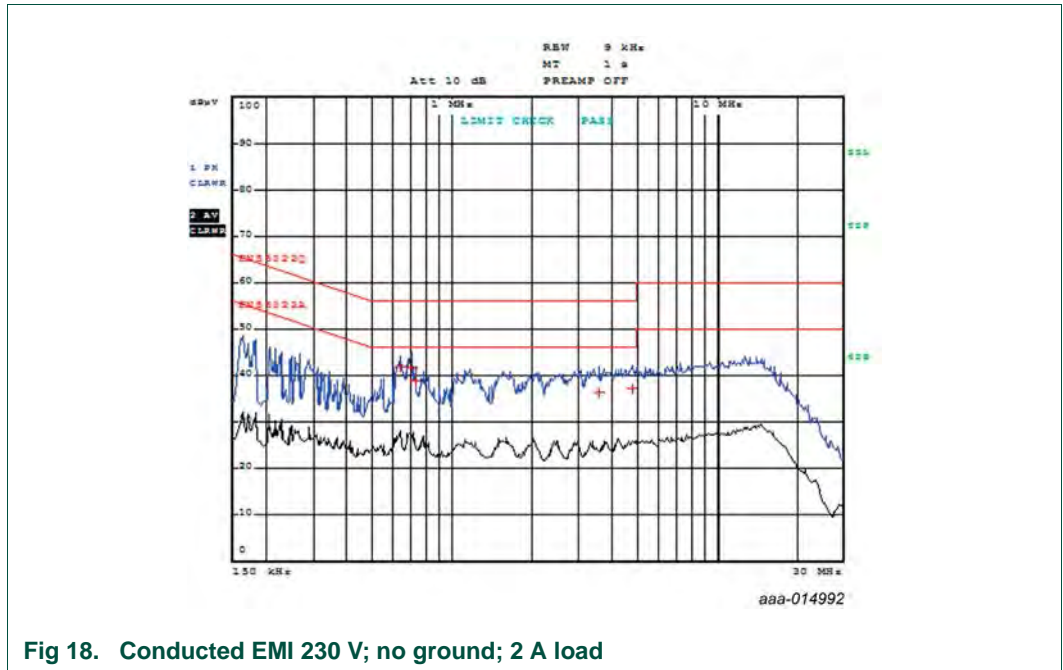
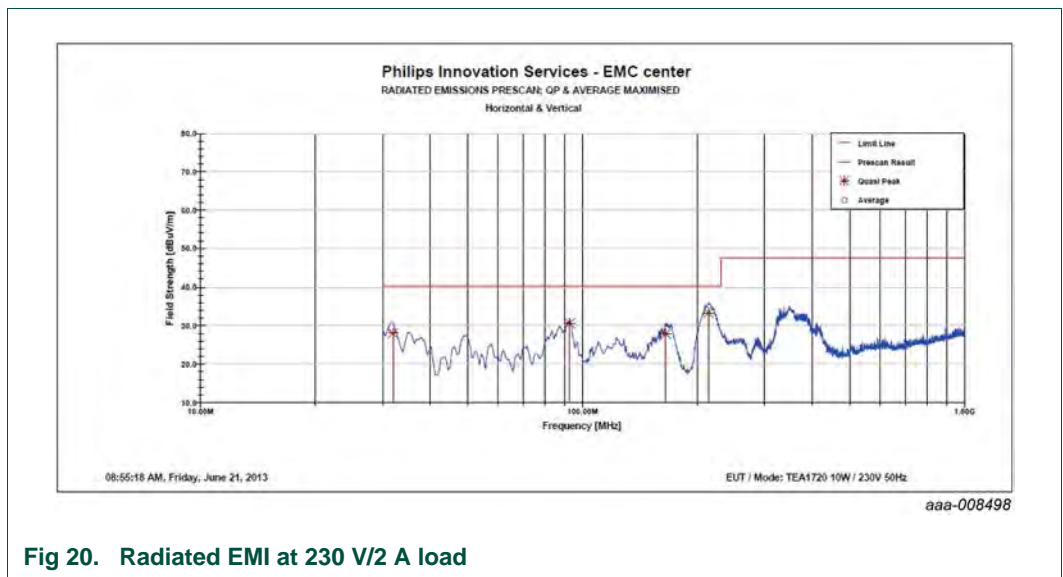
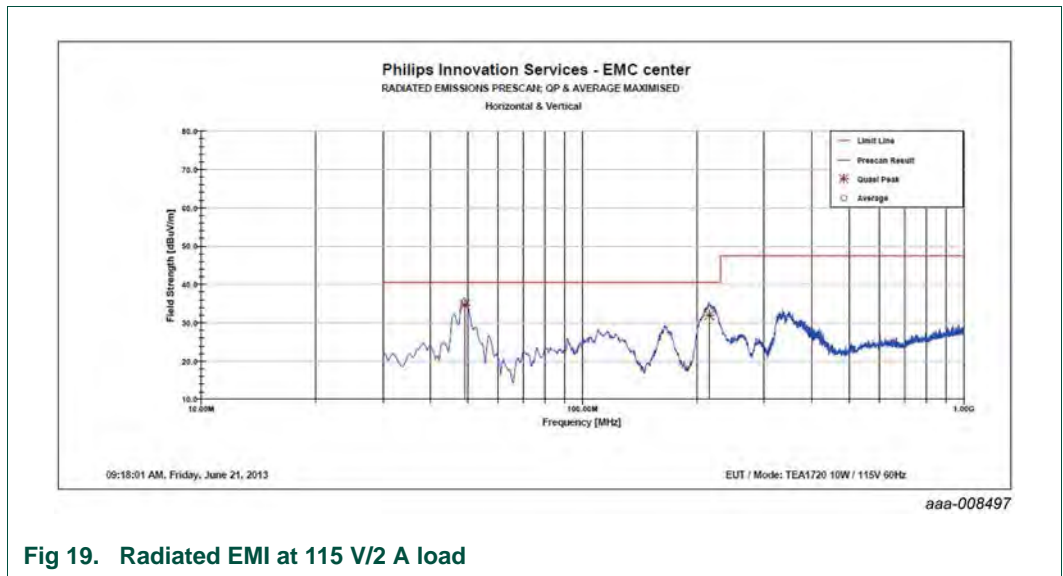

Fig 18. Conducted EMI 230 V; no ground; 2 A load

6.10 Radiated EMI

The radiated EMI is measured according to EN 55022 (30 MHz to 1 GHz). [Figure 19](#) and [Figure 20](#) show the measured results.



6.11 Common-mode noise

Figure 21 shows the result of the EPS switching frequency component of the common-mode noise test. The switching component is below 2 V_{pp}.

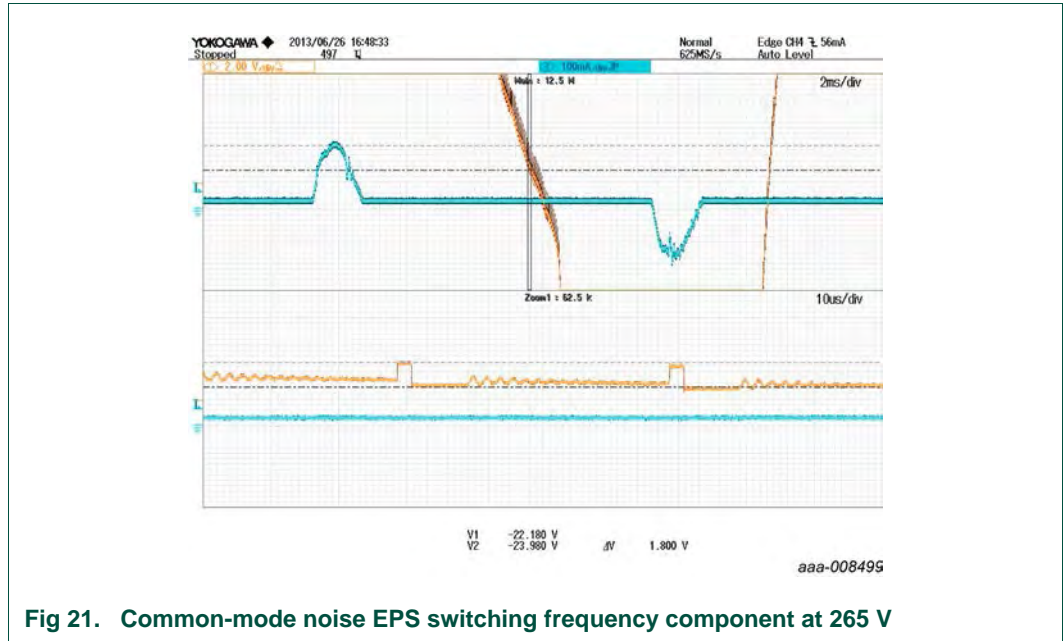

Fig 21. Common-mode noise EPS switching frequency component at 265 V

6.11.1 Test description

The TEA1720ADB1180 demo board has been connected to a 265 V (AC) power source where one or the other of the AC mains is a neutral conductor. It has been connected to the protected earth ground either at the upstream service transformer, or locally in the laboratory environment.

The demo board has been loaded with a 5 Ω, 1 %, resistive load, at the end of a 1 meter USB cable. The 5 Ω load is located in a metal box that represents the equivalent capacitive load of a generic mobile terminal. The EPS switching component has been measured with an 1:100 oscilloscope probe (50 MΩ // 7.5 pF) between the metal box ground and the protective earth ground.

The level of the common-mode noise is measured at the worst position, which is around the mains voltage zero crossing in this case.

The test has been repeated with a 2.5 Ω resistor load. The test result was equal to the 5 Ω test result.

6.12 Thermal measurements

The component temperatures were measured using a temperature chamber. The PCB was placed inside an encasing. To avoid influence of the air flow, the encasing itself is placed inside a box (see [Figure 22](#)).

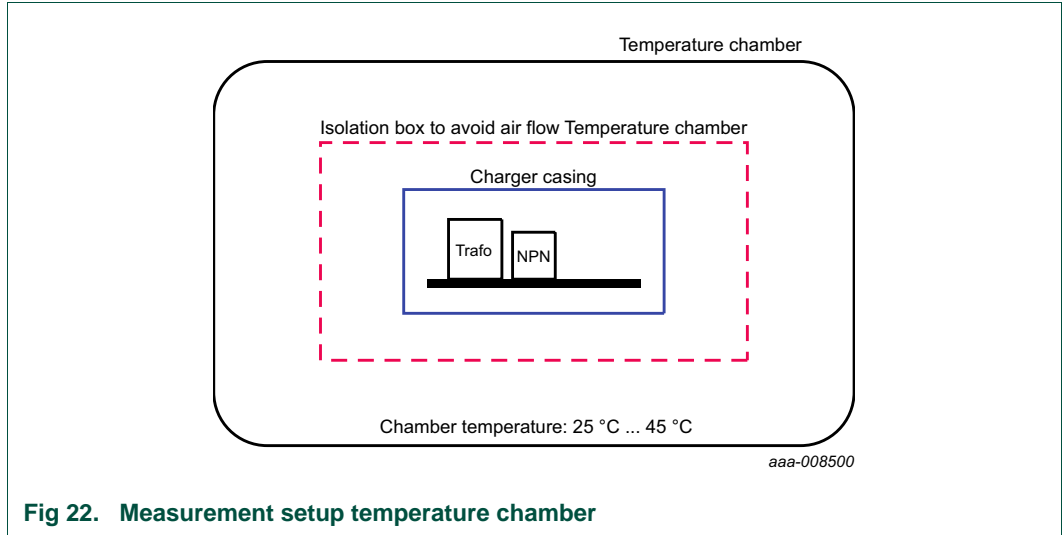

Fig 22. Measurement setup temperature chamber

The component temperatures are measured using thermocouples, glued on the components. The temperatures after 30 minutes warming-up time at 2 A load are shown in [Table 7](#).

Table 7. Component temperatures at 2 A load and $T_{ambient} = 25\text{ °C}/45\text{ °C}$

Chamber temperature		$V_{in} = 90\text{ V}; I_{out} = 2\text{ A}$		$V_{in} = 265\text{ V}; I_{out} = 2\text{ A}$		
		Temperature (°C)		Temperature (°C)		
		25	45	25	45	
1	EPC17	transformer	67	83	66	84
2	TB100	NPN	83	99	90	109
3	TEA1720	controller	73	89	57	65
4	D50/D51	secondary diodes	73	88	72	88
5	R70/R71/R72	base resistors	90	103	73	92
6	C52	output capacitor	58	75	58	75
7	C2	input capacitor	69	83	60	78

7. Schematic

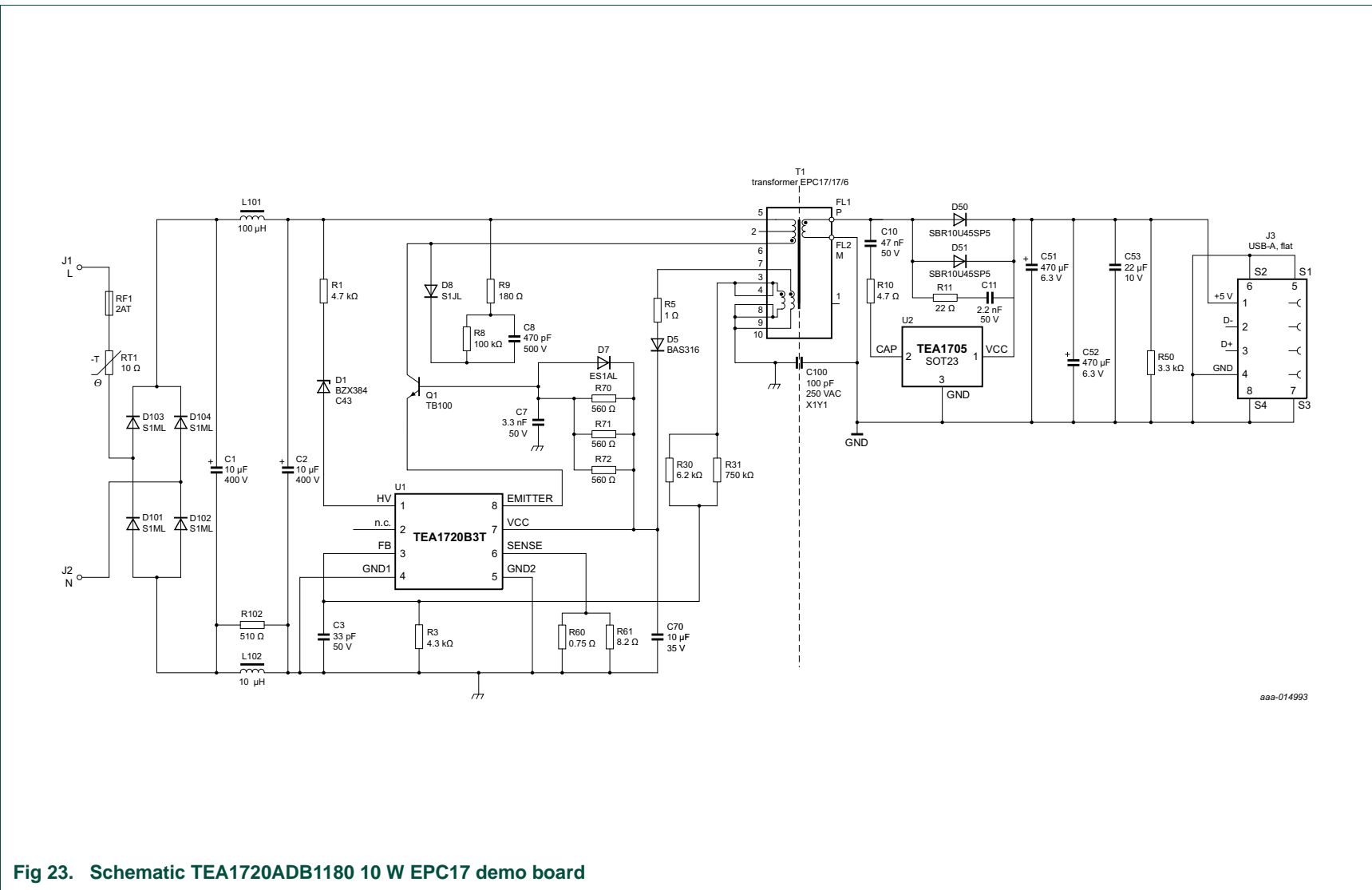

aaa-014993

Fig 23. Schematic TEA1720ADB1180 10 W EPC17 demo board

8. Circuit description

The GreenChip TEA1720ADB1180 demo board consists of a single-phase full wave rectifier circuit, a filtering section, a switching section, an output section and a feedback section. The circuit diagram is shown in [Figure 23](#) and the component list is shown in [Table 8](#).

8.1 Rectification section

The bridge diodes D101 to D104 provide a single-phase full wave rectifier. Capacitors C1 and C2 function as reservoir capacitors for the rectified input voltage. Thermistor RT1 limits inrush current. Terminals J1 and J2 connect the input to the electricity utility network. Swapping these two wires has no effect on the operation of the converter.

8.2 Filtering section

Inductors L1 and L2, with capacitors C1 and C2, form π -filters to attenuate conducted differential-mode EMI noise.

8.3 TEA1720B3T section

The TEA1720B3T device (U1) contains the oscillator, CV/CC control, start-up control, protection functions, high-voltage start-up and emitter switch for switching the external NPN all in one IC.

One auxiliary winding on transformer T1 is used to provide the primary sensing information for the TEA1720B3T. A second auxiliary winding generates the supply voltage. This voltage is (half wave) rectified by diode D5 and capacitor C70. C70 is charged via the current limiter resistor R5. The voltage on C70 is the supply voltage for the VCC pin of the TEA1720B3T and delivers the base current for the NPN transistor.

The RCD-R clamp consisting of R8, C8, D8 and R9 limits drain voltage spikes caused by leakage inductance of the transformer.

8.4 Output section

Diodes D50 and D51, Schottky barrier type diodes, filtered by capacitors C51 and C52 rectify the secondary winding of transformer T1. Using a Schottky barrier type diode results in a higher efficiency of the demo board. C51 and C52 must have sufficient low ESR characteristics to meet the output voltage ripple and noise requirement without adding an LC output filter. Capacitor C11 damps high frequency ringing and reduces the voltage stress on the Schottky diodes. Resistor R50 provides a minimum load to maintain output control in no-load condition.

8.5 Feedback section

The TEA1720B3T controls the output by current and frequency control for CV / CC regulation. The auxiliary winding on Transformer T1 senses the output voltage. The FB pin of the TEA1720B3T senses the reflected output voltage via feedback resistors R30, R31 and R3. C3 is added for noise filtering.

8.6 Transient controller

The TEA1705 secondary side transient controller offers an excellent transient response of the TEA1720B3T controller, with ultra-low no-load power and minimum sized output capacitors. The output voltage is continuously monitored and when the output voltage is below the detection level V_{det} (V_{CC}), a transient interrupt signal is generated. This signal is transmitted via C10 and the transformer to the primary side to wake up the TEA1720B3T. This system reduces the volume of the output capacitors and makes it possible to build compact chargers.

9. PCB layout

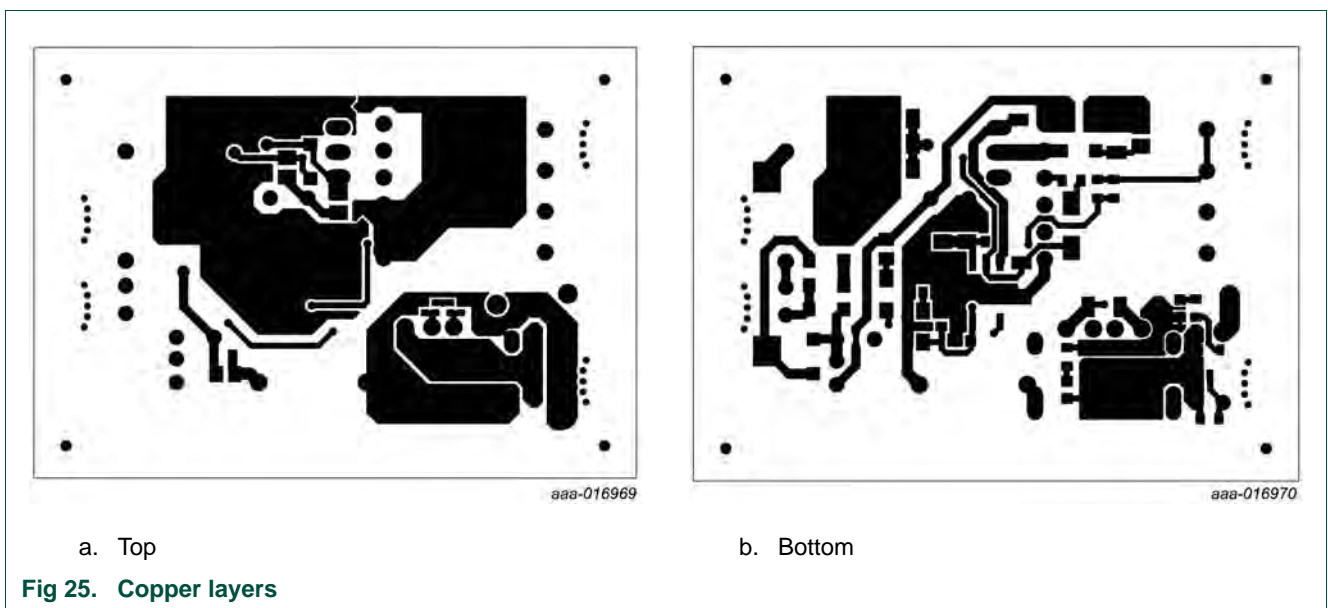
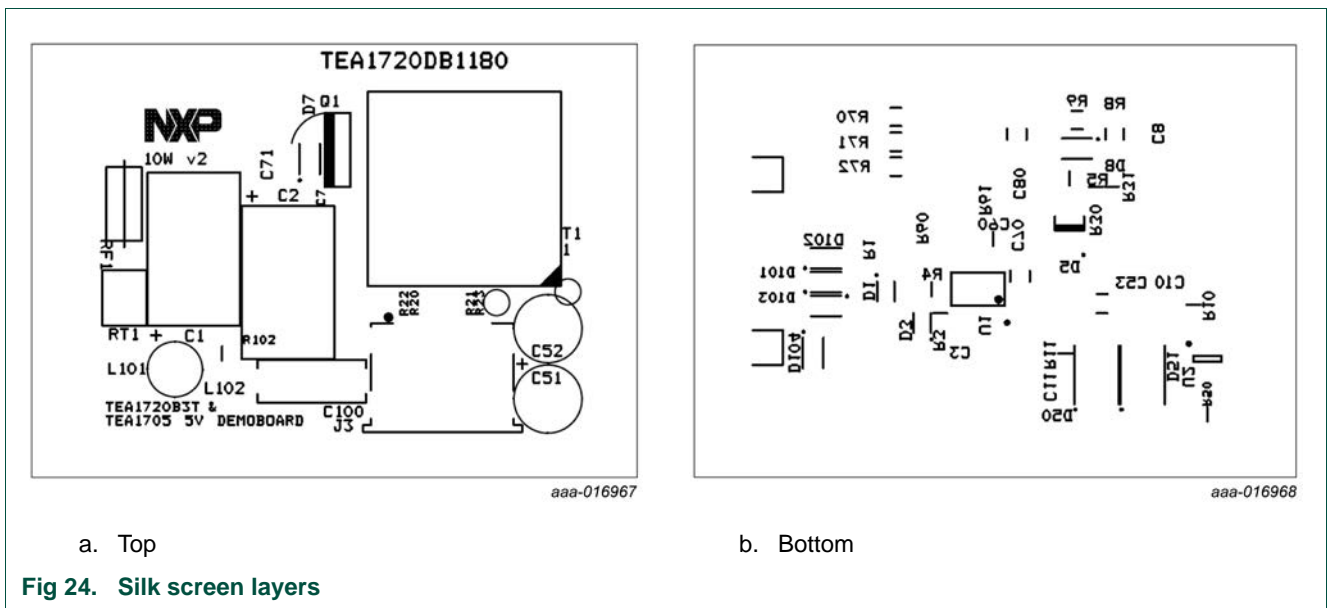

10. Bill Of Material (BOM)

Table 8. TEA1720ADB1180 bill of material

Reference	Description and values	Part number	Manufacturer
C1; C2	capacitor; 10 μ F; 20 %; 400 V; ALU; 8.5 mm \times 14 mm	ERK2GM100F12OT	Aishi
C3	capacitor; 33 pF; 5 %; 50 V; C0G; 0603	-	-
C7	capacitor; 3.3 nF; 10 %; 50 V; X7R; 0805	-	-
C8	capacitor; 470 pF; 5 %; 500 V; C0G; NP0; 0805	CC0805JRNPOBBN471	Yageo
C10	capacitor; 47 nF; 10 %; 50 V; X7R; 0603	-	-
C11	capacitor; 2.2 nF; 10 %; 50 V; X7R; 0603	-	-
C51; C52	capacitor; 470 μ F; 20 %; 6.3 V; ALU; 6.3 mm \times 8 mm	RS80J471MDNASQJT	Nichicon
C53	capacitor; 22 μ F; 10 %; 10 V; X7R; 1206	GRM31CR71A226KE15L	Murata
C70	capacitor; 10 μ F; 20 %; 35 V; X7R; 1206	C3216X7R1V106M160AC	TDK
C100	capacitor; 100 pF; 10 %; 250 V (AC); CD; X1Y1	CD70-B2GA101KYNS	TDK
D1	diode; Zener; 43 V; 200 mA	BZX384-C43	NXP Semiconductors
D5	diode; 100 V; 250 mA	BAS316	NXP Semiconductors
D7	diode; 50 V; 1 A	ES1AL	Taiwan Semiconductor
D8	diode; 600 V; 1 A	S1JL	Taiwan Semiconductor
D50; D51	diode; 45 V; 10 A	SBR10U45SP5-13	Diodes Inc.
D101; D102; D103; D104	diode; 1 kV; 1 A	S1ML	Taiwan Semiconductor
J3	connector; USB-A; flat	USB AF DIP - 94 - H	Gold Conn
L101	inductor; 100 μ H; 10 %; 350 mA	11R104C	Murata
L102	inductor; 10 μ H; 20 %; 520 mA; 0805	CB2012T100MR	Taiyo Yuden
Q1	transistor; NPN; 400 V; 1 A	TB100	NXP Semiconductors
R1	resistor; 4.7 k Ω ; 1 %; 0.1 W; 0805	-	-
R3	resistor; 4.3 k Ω ; 1 %; 0.1 W; 0603	-	-
R5	resistor; 1 Ω ; 1 %; 0.1 W; 0603	-	-
R8	resistor; 100 k Ω ; 1 %; 0.25 W; 1206	-	-
R9	resistor; 180 Ω ; 1 %; 0.25 W; 1206	-	-

Table 8. TEA1720ADB1180 bill of material ...continued

Reference	Description and values	Part number	Manufacturer
R10	resistor; 4.7 Ω ; 1 %; 0.1 W; 0603	-	-
R11	resistor; 22 Ω ; 1 %; 100 mW; 0603	-	-
R30	resistor; 6.2 k Ω ; 1 %; 0603	-	-
R31	750 k Ω ; 1 %; 0603	-	-
R50	resistor; 3.3 k Ω ; 1 %; 0.1 W; 0603	-	-
R60	resistor; 0.75 Ω ; 1 %; 0.25 W; 0805	-	-
R61	resistor; 8.2 Ω ; 1 %; 0.25 W; 0805	-	-
R70; R71; R72	resistor; 560 Ω ; 1 %; 500 mW; 1206	-	-
R102	resistor; 510 Ω ; 1 %; 200 mW; 0603	-	-
RF1	fuse; slow blow; 250 V; 2 A	MCPMP 2A 250V	Multicomp
RT1	thermistor; NTC; 10 Ω ; 5 %	NTCLE100E3109JB0	Vishay
T1	transformer; EPC17/17/6; 4:6 pins	750313911	Würth Elektronik
U1	flyback converter, TEA1720B3T	TEA1720B3T	NXP Semiconductors
U2	IC; TEA1705, SOT23	TEA1705	NXP Semiconductors

11. Transformer design

11.1 Transformer schematic design and winding construction

The transformer used in the TEA1720ADB1180 demo board has size EPC17.

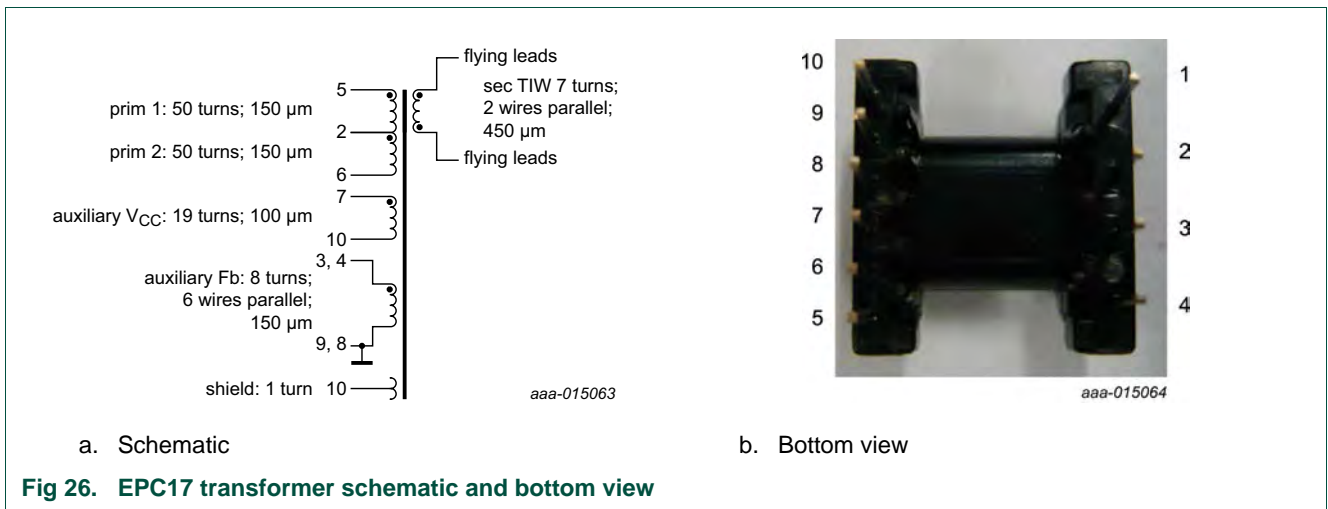

Fig 26. EPC17 transformer schematic and bottom view

Table 9. Transformer specifications

Feature	Values
bobbin	EPC17
ferrite material	3C90 or equivalent
output voltage	5.3 V at 2 A (150 m Ω cable compensation)
input voltage	90 V to 265 V (AC)
output current	2 A
maximum switching frequency	52 kHz
inductance	880 μH ; $\pm 3\%$

11.2 Construction

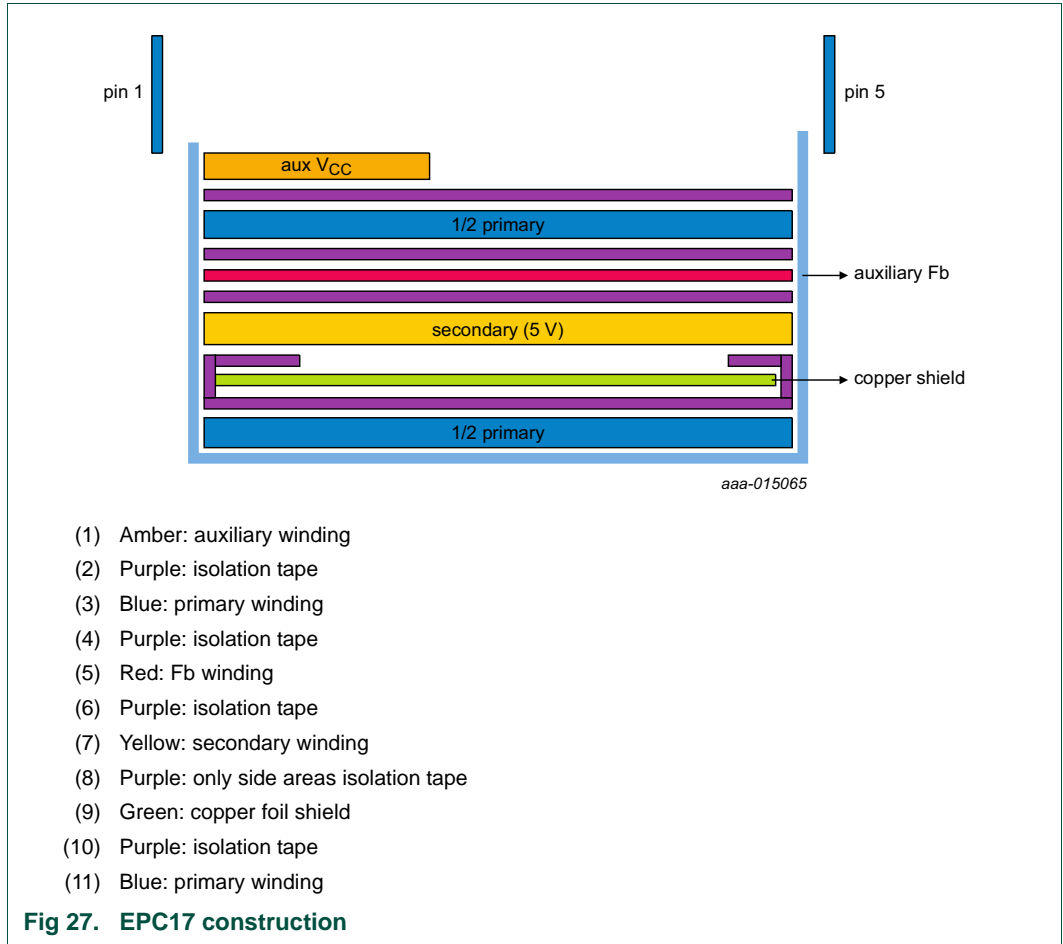

Table 10. Wiring description

Wire	Description
1/2 primary 1 layer	50 turns; wire thickness = 150 μm
shield	1 turn
secondary 1 layer	7 turns; two wires in parallel; wire thickness = 450 μm TIW
auxiliary Fb	8 turns; 6 wires in parallel; wire thickness 150 μm
1/2 primary 1 layer	50 turns; wire thickness = 150 μm
auxiliary V _{CC}	19 turns; wire thickness = 150 μm

Primary-inductance = 880 μH

12. Points of attention

When testing the CC-mode of the TEA1720B3T, it is necessary to use a DC electronic load in resistive mode, not in current mode. The current in CC-mode has a small fold back characteristic (see [Figure 4](#) and [Figure 5](#)). When current mode of a DC electronic load is used, the output voltage drops immediate to zero when the maximum current is exceeded. When the output voltage becomes zero, causing the input voltage of the used DC electronic load to become zero as well, many DC electronic loads can no longer adjust the current. Using the resistive mode of the DC electronic load avoids this problem.

Below $V_{out} = 2.7$ V at the PCB end, the TEA1720B3T enters hiccup mode to limit the output power.

Remark: This behavior of the TEA1720B3T controller is not incorrect. It is only required to test it in the correct way.

13. Legal information

13.1 Definitions

Draft — The document is a draft version only. The content is still under internal review and subject to formal approval, which may result in modifications or additions. NXP Semiconductors does not give any representations or warranties as to the accuracy or completeness of information included herein and shall have no liability for the consequences of use of such information.

13.2 Disclaimers

Limited warranty and liability — Information in this document is believed to be accurate and reliable. However, NXP Semiconductors does not give any representations or warranties, expressed or implied, as to the accuracy or completeness of such information and shall have no liability for the consequences of use of such information. NXP Semiconductors takes no responsibility for the content in this document if provided by an information source outside of NXP Semiconductors.

In no event shall NXP Semiconductors be liable for any indirect, incidental, punitive, special or consequential damages (including - without limitation - lost profits, lost savings, business interruption, costs related to the removal or replacement of any products or rework charges) whether or not such damages are based on tort (including negligence), warranty, breach of contract or any other legal theory.

Notwithstanding any damages that customer might incur for any reason whatsoever, NXP Semiconductors' aggregate and cumulative liability towards customer for the products described herein shall be limited in accordance with the *Terms and conditions of commercial sale* of NXP Semiconductors.

Right to make changes — NXP Semiconductors reserves the right to make changes to information published in this document, including without limitation specifications and product descriptions, at any time and without notice. This document supersedes and replaces all information supplied prior to the publication hereof.

Suitability for use — NXP Semiconductors products are not designed, authorized or warranted to be suitable for use in life support, life-critical or safety-critical systems or equipment, nor in applications where failure or malfunction of an NXP Semiconductors product can reasonably be expected to result in personal injury, death or severe property or environmental damage. NXP Semiconductors and its suppliers accept no liability for inclusion and/or use of NXP Semiconductors products in such equipment or applications and therefore such inclusion and/or use is at the customer's own risk.

Applications — Applications that are described herein for any of these products are for illustrative purposes only. NXP Semiconductors makes no representation or warranty that such applications will be suitable for the specified use without further testing or modification.

Customers are responsible for the design and operation of their applications and products using NXP Semiconductors products, and NXP Semiconductors accepts no liability for any assistance with applications or customer product

design. It is customer's sole responsibility to determine whether the NXP Semiconductors product is suitable and fit for the customer's applications and products planned, as well as for the planned application and use of customer's third party customer(s). Customers should provide appropriate design and operating safeguards to minimize the risks associated with their applications and products.

NXP Semiconductors does not accept any liability related to any default, damage, costs or problem which is based on any weakness or default in the customer's applications or products, or the application or use by customer's third party customer(s). Customer is responsible for doing all necessary testing for the customer's applications and products using NXP Semiconductors products in order to avoid a default of the applications and the products or of the application or use by customer's third party customer(s). NXP does not accept any liability in this respect.

Export control — This document as well as the item(s) described herein may be subject to export control regulations. Export might require a prior authorization from competent authorities.

Evaluation products — This product is provided on an "as is" and "with all faults" basis for evaluation purposes only. NXP Semiconductors, its affiliates and their suppliers expressly disclaim all warranties, whether express, implied or statutory, including but not limited to the implied warranties of non-infringement, merchantability and fitness for a particular purpose. The entire risk as to the quality, or arising out of the use or performance, of this product remains with customer.

In no event shall NXP Semiconductors, its affiliates or their suppliers be liable to customer for any special, indirect, consequential, punitive or incidental damages (including without limitation damages for loss of business, business interruption, loss of use, loss of data or information, and the like) arising out of the use of or inability to use the product, whether or not based on tort (including negligence), strict liability, breach of contract, breach of warranty or any other theory, even if advised of the possibility of such damages.

Notwithstanding any damages that customer might incur for any reason whatsoever (including without limitation, all damages referenced above and all direct or general damages), the entire liability of NXP Semiconductors, its affiliates and their suppliers and customer's exclusive remedy for all of the foregoing shall be limited to actual damages incurred by customer based on reasonable reliance up to the greater of the amount actually paid by customer for the product or five dollars (US\$5.00). The foregoing limitations, exclusions and disclaimers shall apply to the maximum extent permitted by applicable law, even if any remedy fails of its essential purpose.

Translations — A non-English (translated) version of a document is for reference only. The English version shall prevail in case of any discrepancy between the translated and English versions.

13.3 Trademarks

Notice: All referenced brands, product names, service names and trademarks are the property of their respective owners.

GreenChip — is a trademark of NXP Semiconductors N.V.

14. Contents

1	Introduction	3
2	Safety warning	3
3	Features	4
3.1	Power features	4
3.2	Green features	4
3.3	Protection features	4
4	Technical specifications	5
5	Board photographs	5
6	Performance data	6
6.1	No-load input power consumption	6
6.2	VI curves	7
6.3	Efficiency	9
6.4	Transient response TEA1720B3T	10
6.5	Turn-on delay and output rise time	14
6.6	Output voltage ripple and noise performance	16
6.7	Inrush current	17
6.8	Short circuit	17
6.9	Conducted EMI	17
6.10	Radiated EMI	19
6.11	Common-mode noise	20
6.11.1	Test description	20
6.12	Thermal measurements	21
7	Schematic	22
8	Circuit description	23
8.1	Rectification section	23
8.2	Filtering section	23
8.3	TEA1720B3T section	23
8.4	Output section	23
8.5	Feedback section	23
8.6	Transient controller	24
9	PCB layout	24
10	Bill Of Material (BOM)	25
11	Transformer design	27
11.1	Transformer schematic design and winding construction	27
11.2	Construction	28
12	Points of attention	29
13	Legal information	30
13.1	Definitions	30
13.2	Disclaimers	30
13.3	Trademarks	30
14	Contents	31

Please be aware that important notices concerning this document and the product(s) described herein, have been included in section 'Legal information'.

© NXP Semiconductors N.V. 2015.

All rights reserved.

For more information, please visit: <http://www.nxp.com>

For sales office addresses, please send an email to: salesaddresses@nxp.com

Date of release: 2 March 2015

Document identifier: UM10886