



Revisions

Rev	Description	Date	Approved
X1	INITIAL RELEASE FOR AGILE UPLOAD	30-OCT-13	I. Lovas
A	FIRST RELEASE	15-JAN-14	I. Lovas
AX1	SECOND RELEASE FOR AGILE UPLOAD	16-MAY-14	I. Lovas
B	SECOND RELEASE FOR PRODUCTION	10-JUN-14	I. Lovas
C	ADDED SOME CAPS DUE TO FCC/CE	03-NOV-14	I. Lovas
D			

		Freescale Semiconductor RCSC	
		1. maje 1009 765 61 Roznov p. R. Czech republic, Europe	
This document contains information proprietary to Freescale Semiconductor and shall not be used for engineering design, procurement or manufacture in whole or in part without the express written permission of Freescale Semiconductor.			
ICAP Classification: FCP: _____ FIUO: X PUBL: _____			
Designer: Ivan Lovas	Drawing Title: HVP-56F82748		
Drawn by: Ivan Lovas	Page Title: Title page		
Approved: X	Size A4	Document Number SCH-28120, SPF-28120	Rev C
Date:	Monday, November 10, 2014	Sheet 1	of 6



5

4

3

2

1

D

C

B

A

D

C

B

A

		Freescale Semiconductor RCSC 1. maje 1009 765 61 Roznov p. R. Czech republic, Europe		
		This document contains information proprietary to Freescale Semiconductor and shall not be used for engineering design, procurement or manufacture in whole or in part without the express written permission of Freescale Semiconductor.		
		ICAP Classification: FCP: _____ FIUO: X PUBL: _____		
Designer: Ivan Lovas	Drawing Title: HVP-56F82748			
Drawn by: Ivan Lovas	Page Title: Notes			
Approved: X	Size A4	Document Number SCH-28120, SPF-28120		Rev C
		Date:	Monday, November 10, 2014	Sheet 2 of 6

5

4

3

2

1

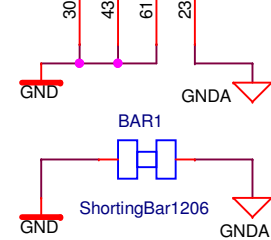
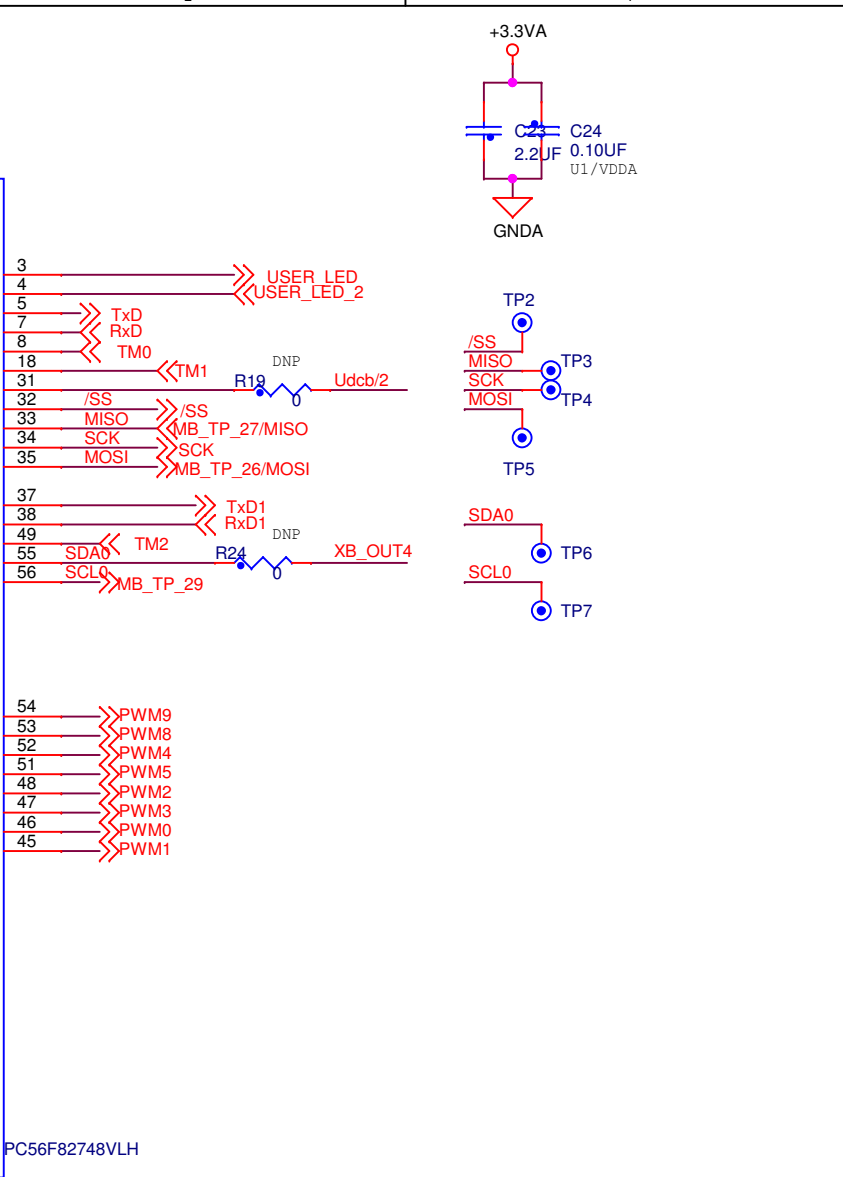
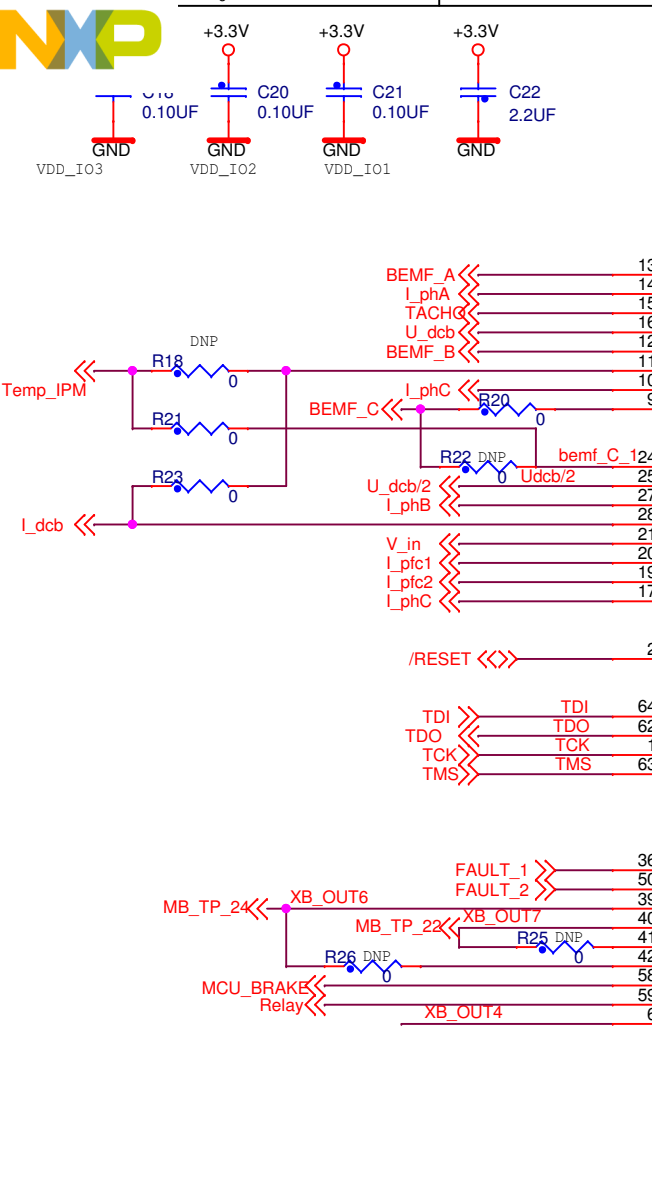
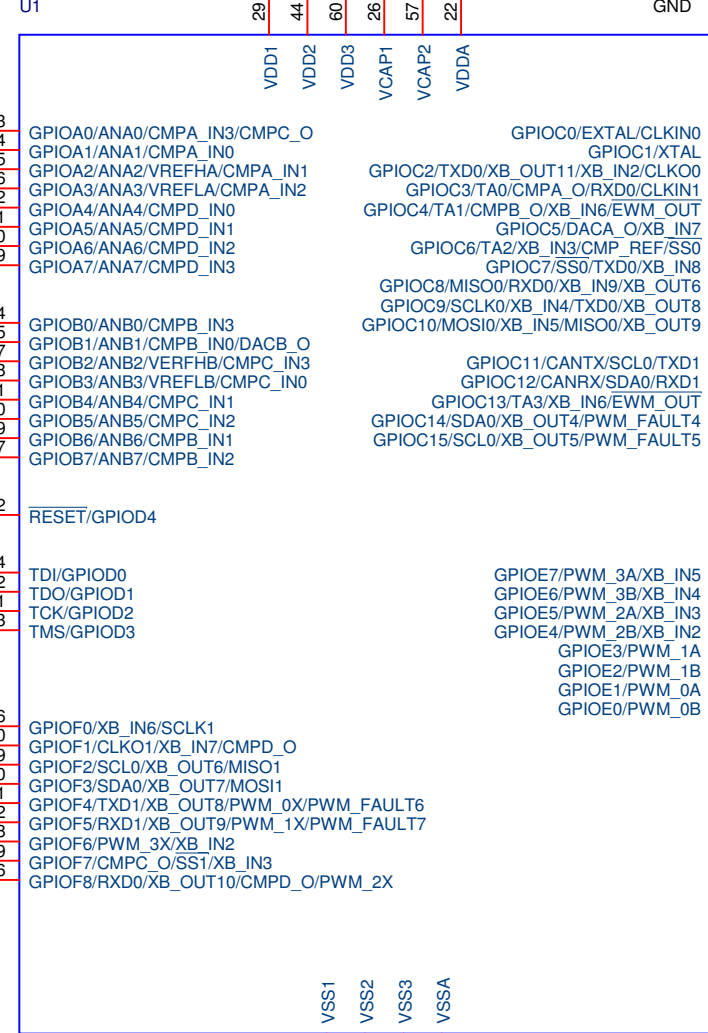
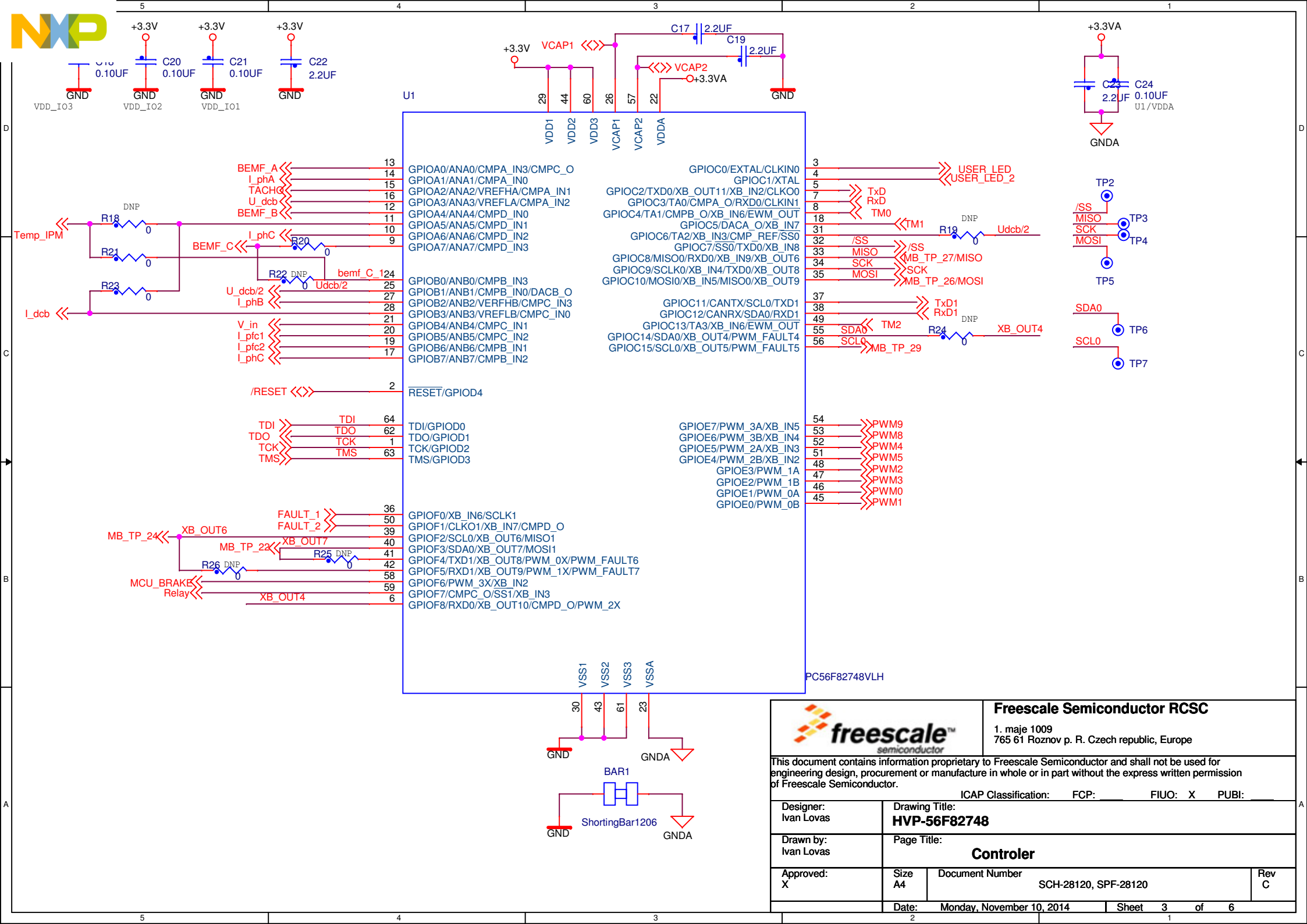

		Freescale Semiconductor RCSC 1. maja 1009 765 61 Roznov p. R. Czech republic, Europe	
ICAP Classification: FCP: FIUO: X PUBI:			
Designer: Ivan Lovas	Drawing Title: HVP-56F82748		
Drawn by: Ivan Lovas	Page Title: Controler		
Approved: X	Size A4	Document Number SCH-28120, SPF-28120	Rev C
Date: Monday, November 10, 2014		Sheet 3 of 6	



Target MCU JTAG Connector Isolated part near USB

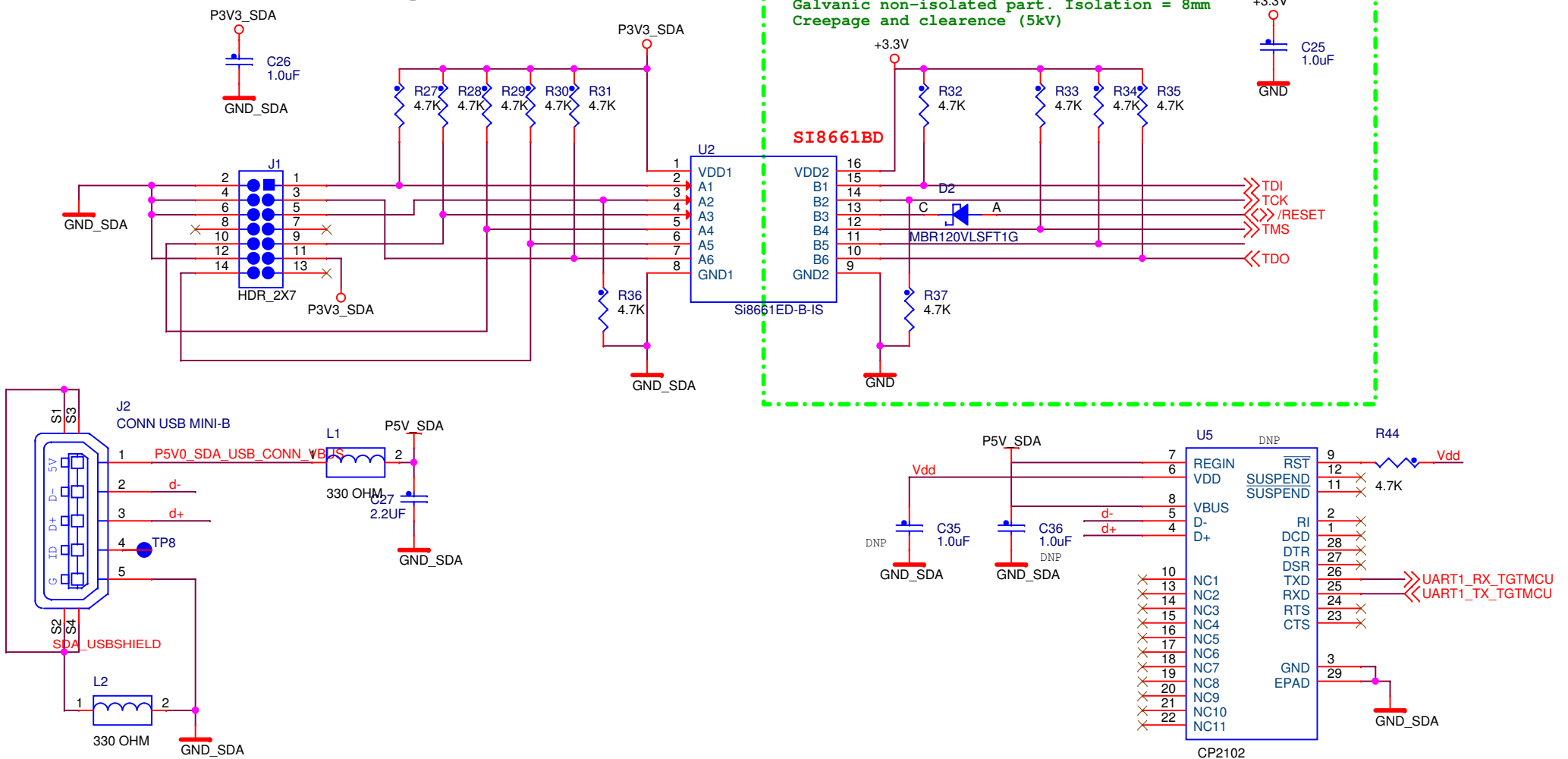

		Freescale Semiconductor RCSC 1. maje 1009 765 61 Roznov p. R. Czech republic, Europe	
		This document contains information proprietary to Freescale Semiconductor and shall not be used for engineering design, procurement or manufacture in whole or in part without the express written permission of Freescale Semiconductor.	
Designer: Ivan Lovas		Drawing Title: HVP-56F82748	
Drawn by: Ivan Lovas		Page Title: SDA	
Approved: X		Size A4	Document Number SCH-28120, SPF-28120
Date: Monday, November 10, 2014		Sheet 4 of 6	

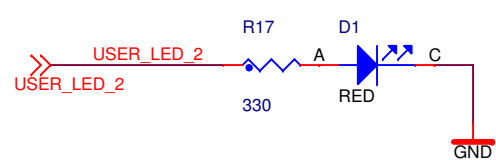
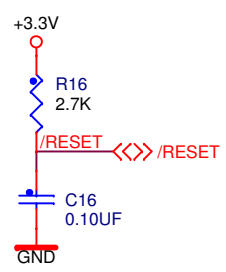
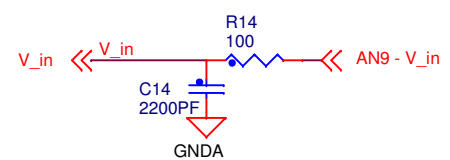
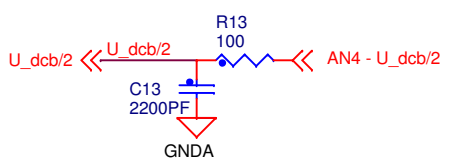
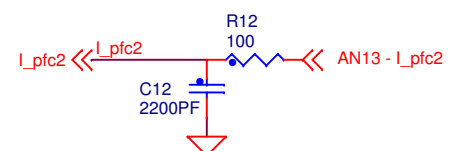
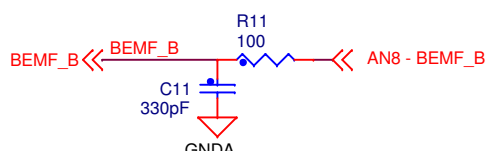
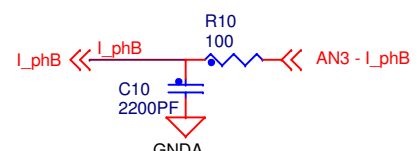
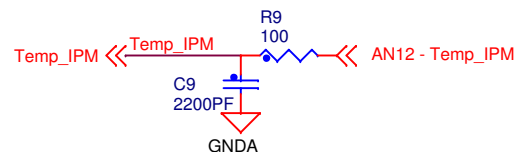
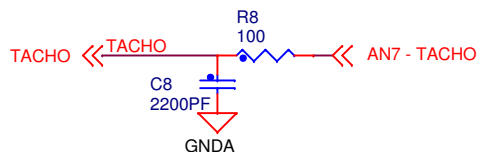
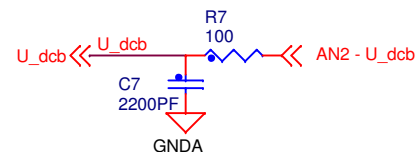
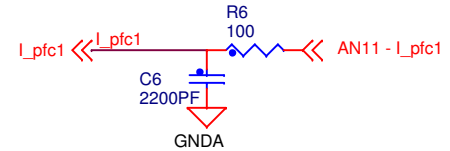
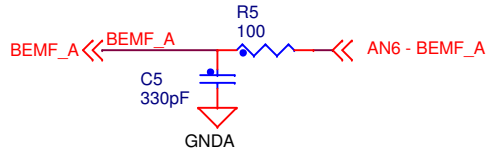
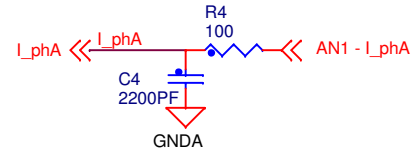
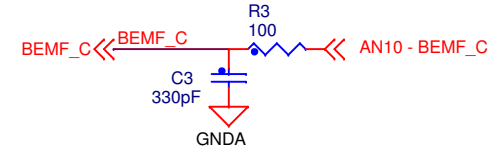
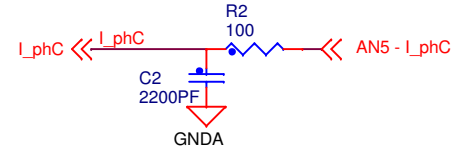
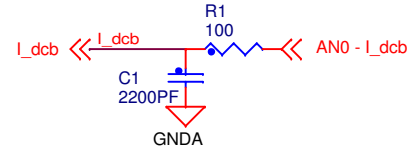

		Freescale Semiconductor RCSC 1. maje 1009 765 61 Roznov p. R. Czech republic, Europe	
		This document contains information proprietary to Freescale Semiconductor and shall not be used for engineering design, procurement or manufacture in whole or in part without the express written permission of Freescale Semiconductor.	
ICAP Classification: FCP: _____ FIUO: X PUBL: _____			
Designer: Ivan Lovas	Drawing Title: HVP-56F82748		
Drawn by: Ivan Lovas	Page Title: Analog filters		
Approved: X	Size A4	Document Number SCH-28120, SPF-28120	Rev C
Date: Monday, November 10, 2014		Sheet 5 of 6	

D
C
B
A

