

NXP Microcontroller Systems, Inc. 6800 North Pointe Drive Maitland, FL 32751 USA		
©2008 NXP Microcontroller Systems, Inc.		
Doc ID: 974824	Rev: 1.0	Date: 2008-01-09
Page: 1 of 1	Part: 974824	Rev: 1.0

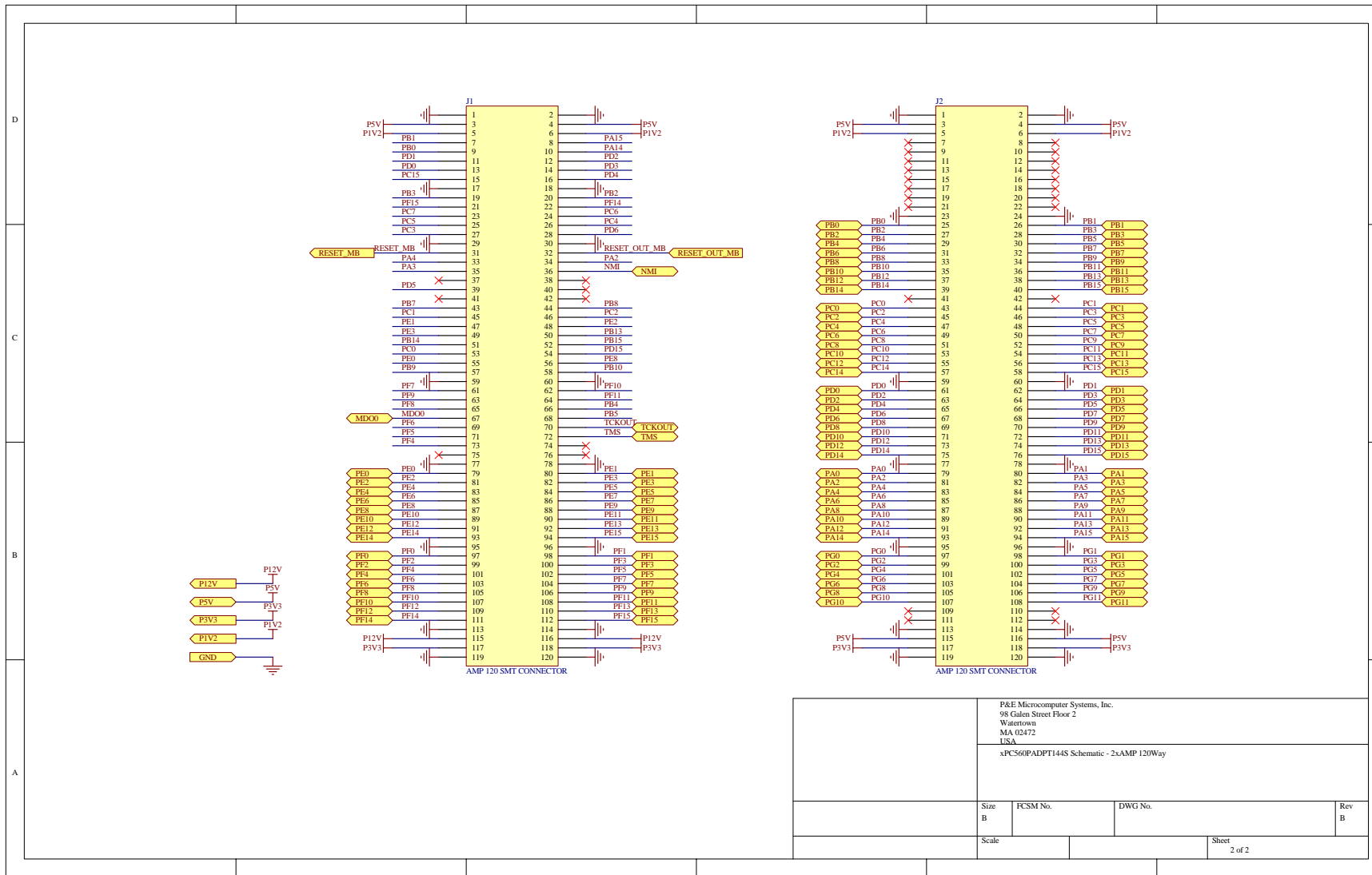

P&E Microcomputer Systems, Inc. 98 Galen Street Floor 2 Watertown, MA 02472 USA			
xPC560PADPT144S Schematic - 2xAMP 120Way			
Size B	FCSM No.	DWG No.	Rev B
Scale	Sheet		2 of 2

# XPC560P 144LQFP MINI-MODULE

Rev. B  
GND

EXTERNAL 5V OR 3V3  
ON OFF

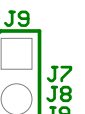
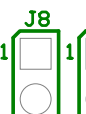
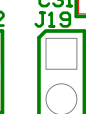
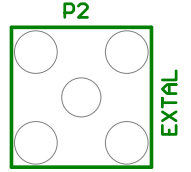
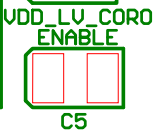
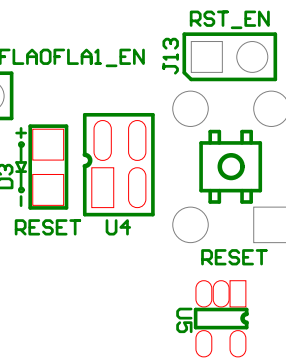
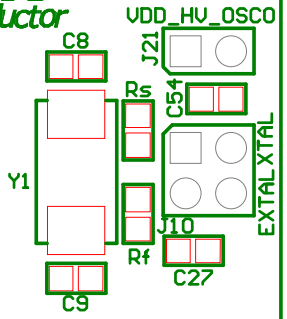
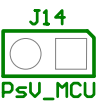
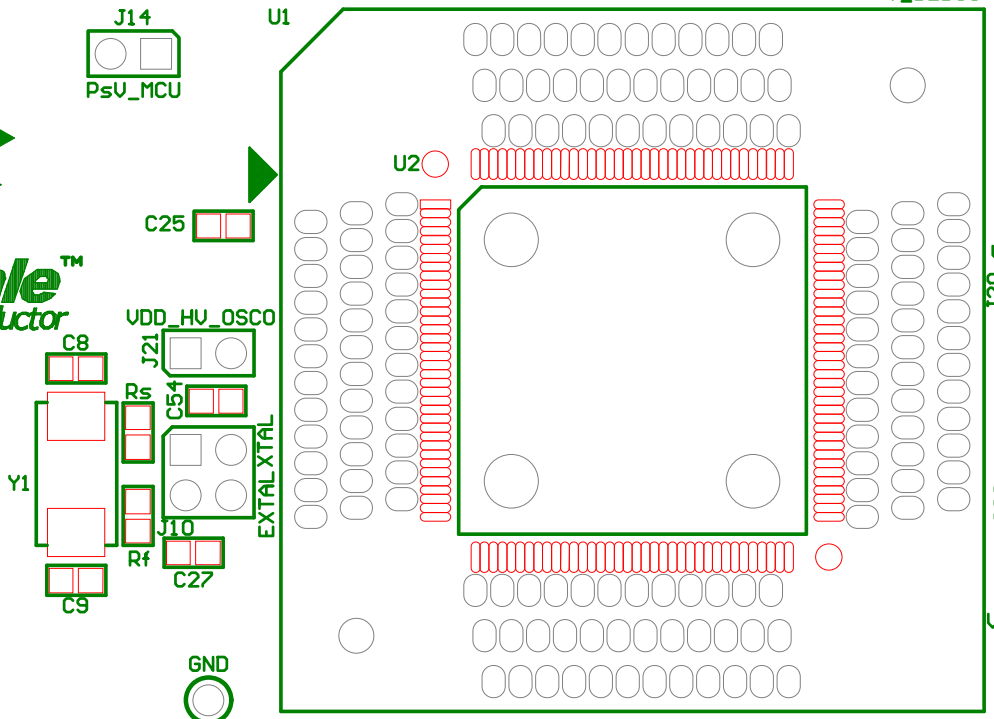
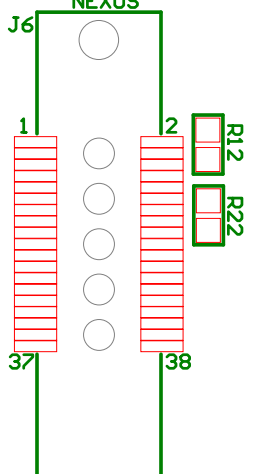
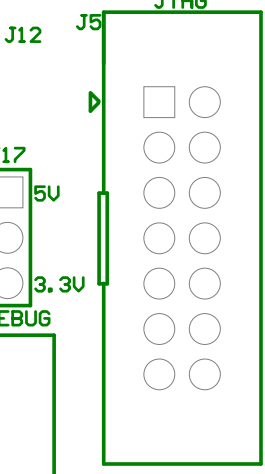
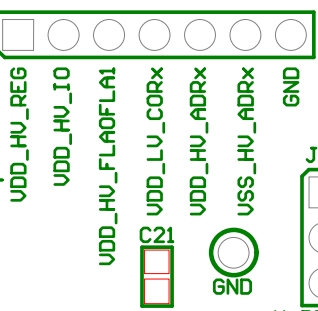
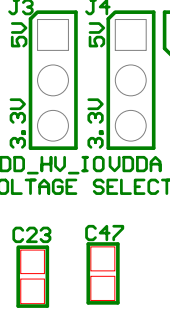
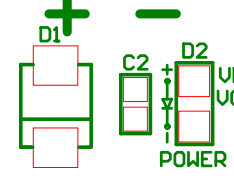
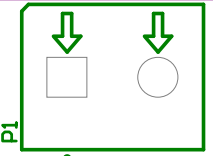
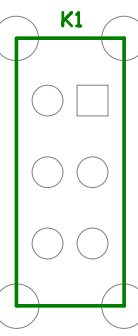

UDD\_HV\_REG 0 0 0  
BOOT CONFIGURATION

J7 - FAB  
J8 - ABS0  
J9 - ABS2



